

KORA

3

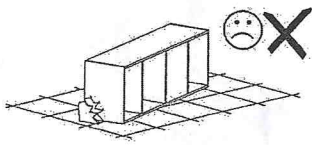

Narzędzia potrzebne do montażu

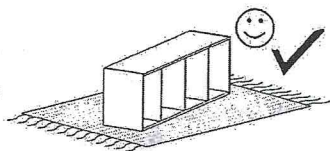
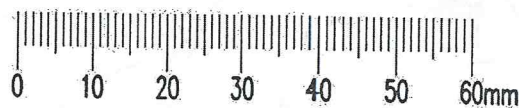
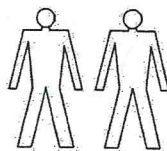
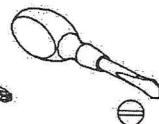
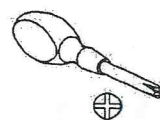
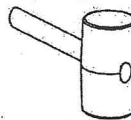
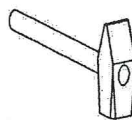

UWAGA !
MONTOWANIE USZKODZONYCH
ELEMENTÓW POWODUJE UTRATĘ
GWARANCJI

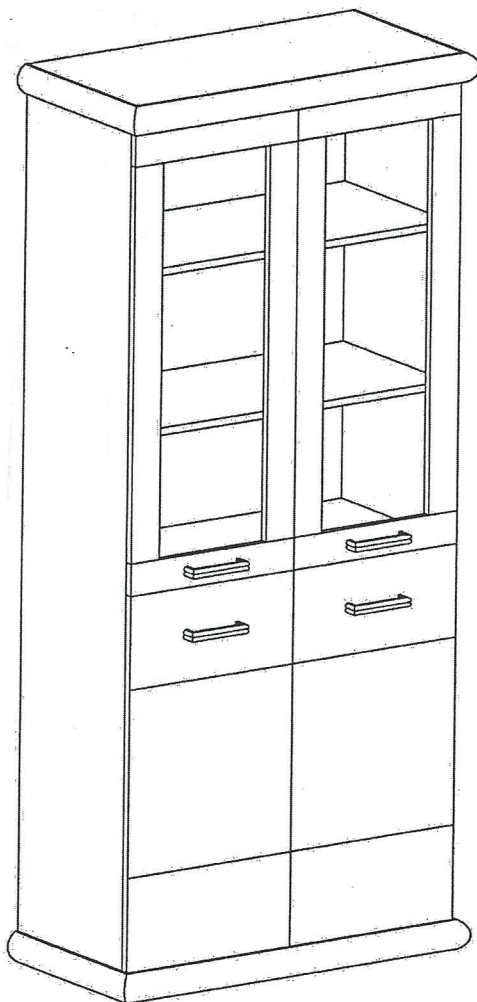

UWAGA !
Mebel zawiera
elementy drewniane

W przypadku reklamacji proszę o podanie numeru pakowacza znajdującego się na kartonie

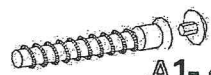

A1 - 4 St.
A - 4 St.

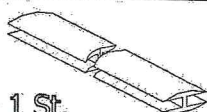

H - 1 St.

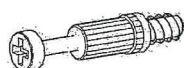

K - 8 St.

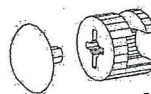

L - 8 St.

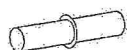

S - 12 St.

F - 4 St.

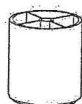

U - 4 St.



D - 8 St.

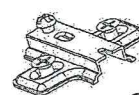

C - 8 St.



E - 90 St.



B - 12 St.

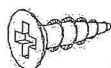

G - 16 St.
3,5 x 16 mm

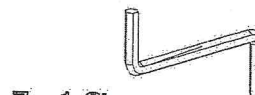

Z - 1 St.

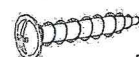

N - 8 St.
4 x 30 mm

1

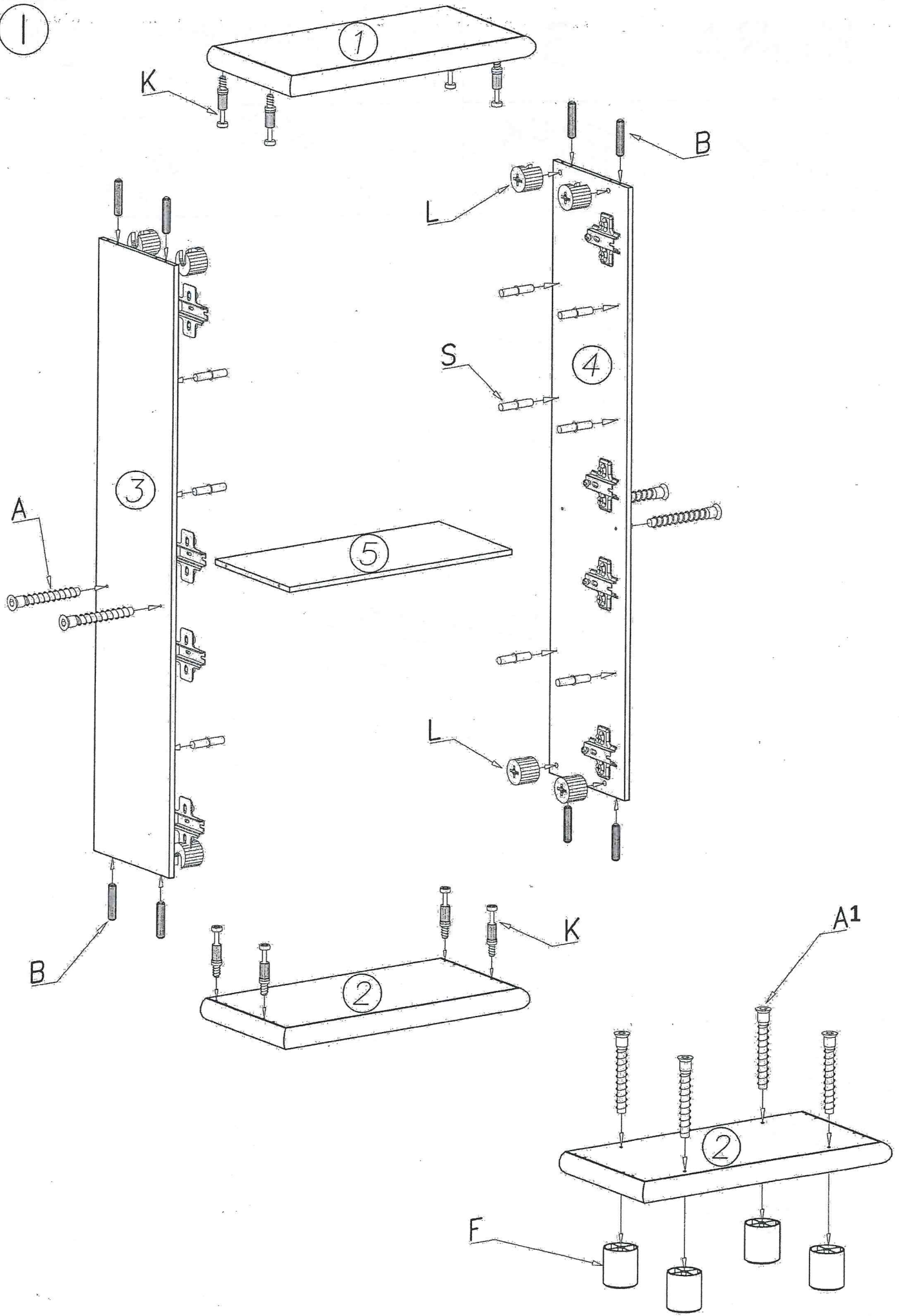

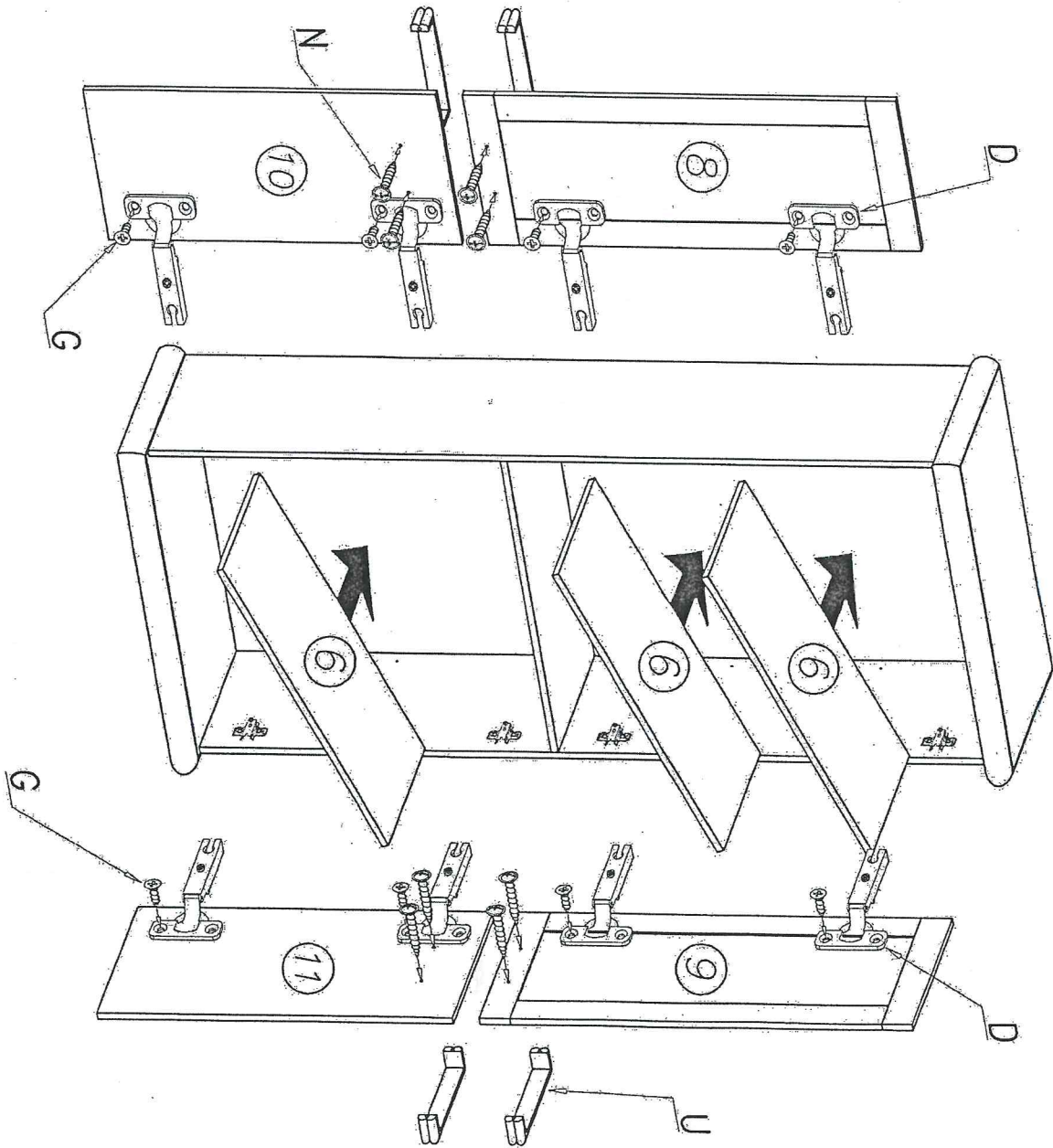
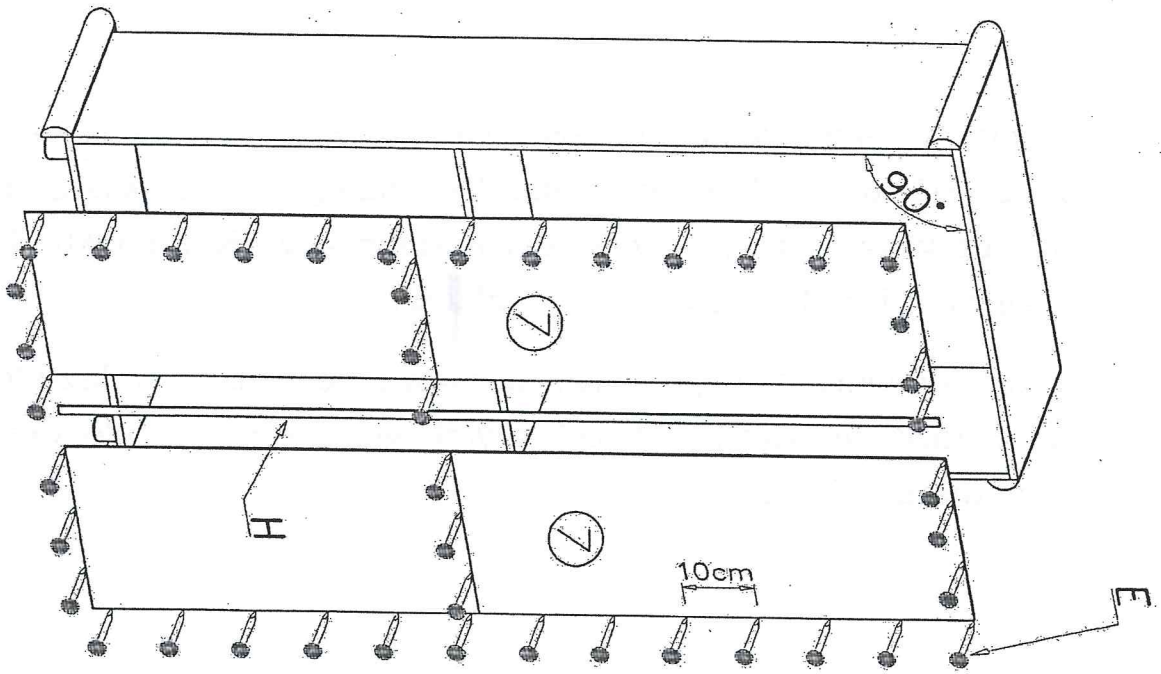

Meble zawierają elementy drewniane , których barwa i układ słoików są uzależnione od wielu czynników, dlatego mogą występować różnice w fakturze i barwie co nie stanowi wady produktu i nie wpływa na jego trwałość i funkcjonalność.

Listwy drewniane mogą ujawniać niewielkie zmiany w kształcie i wymiarach wywołane specyficznymi warunkami eksploatacji – wilgotność, różnice temperatur etc.