

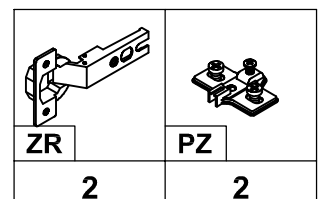

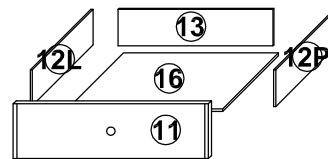

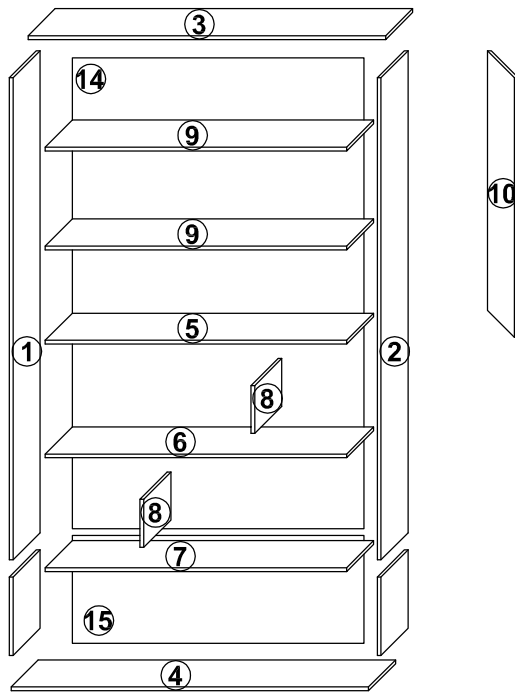

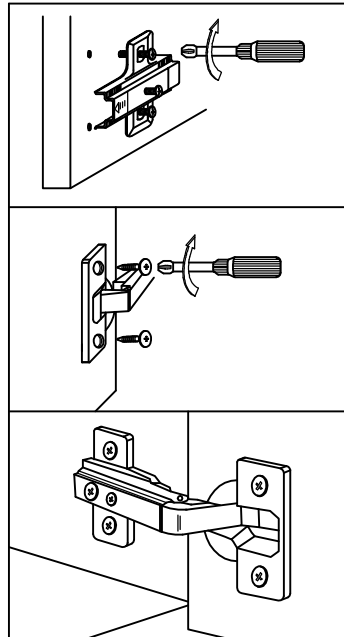

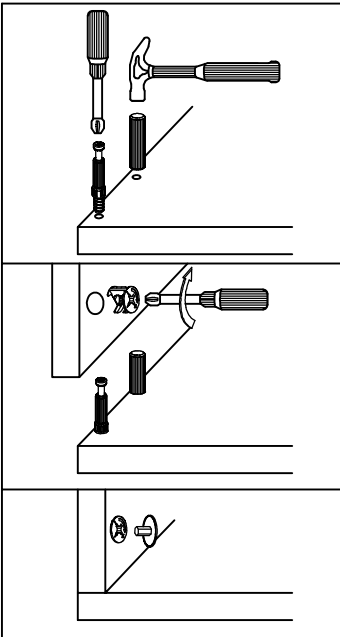
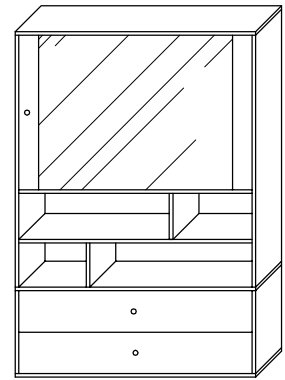
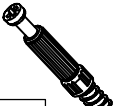



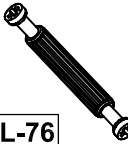
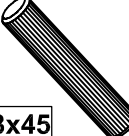

# MIKI 2

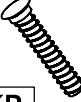

								
TM	MM	ZMB	ZMC	L-76	8x45	8x30	E5x13	U1
24	32	24	8	4	4	44	16	3
								
W4x27	PP	KLEJ	KP	NS	W4x20	STB	W4x16	
3	8	2	4	4	16	12	4	

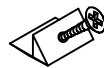

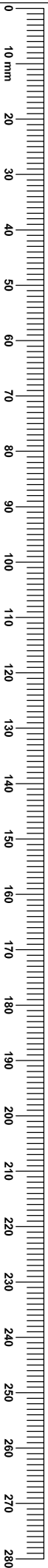
1

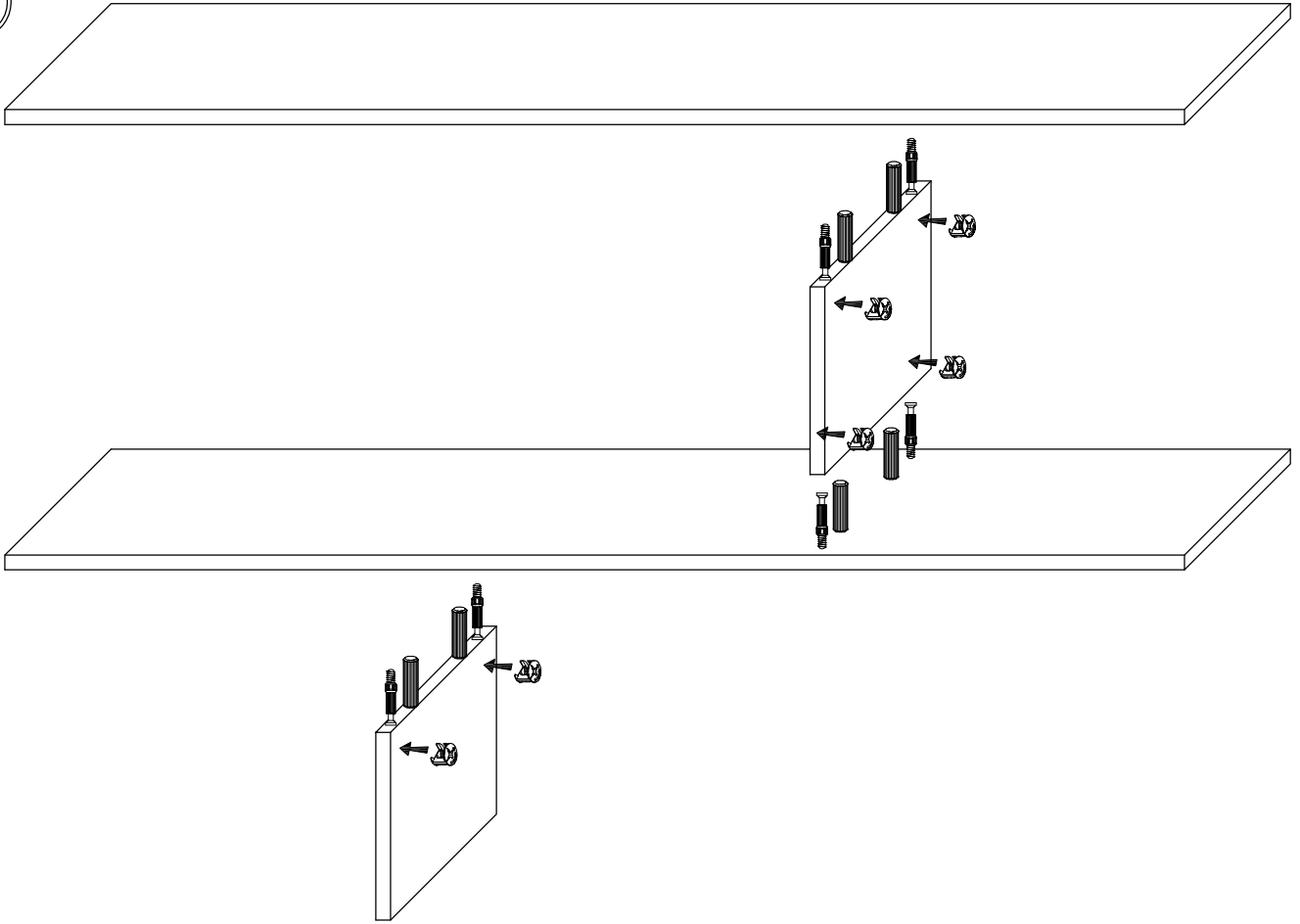

2

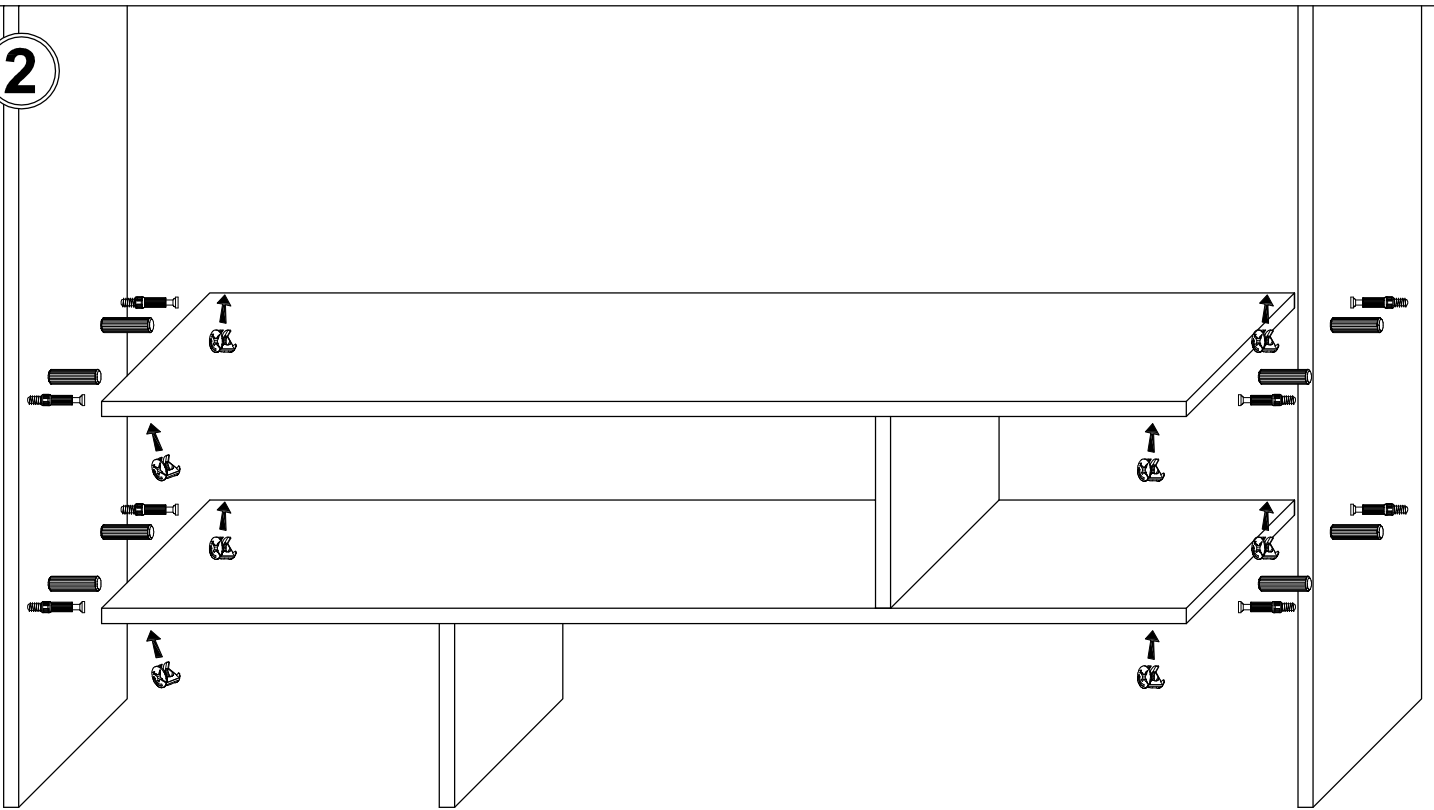

3

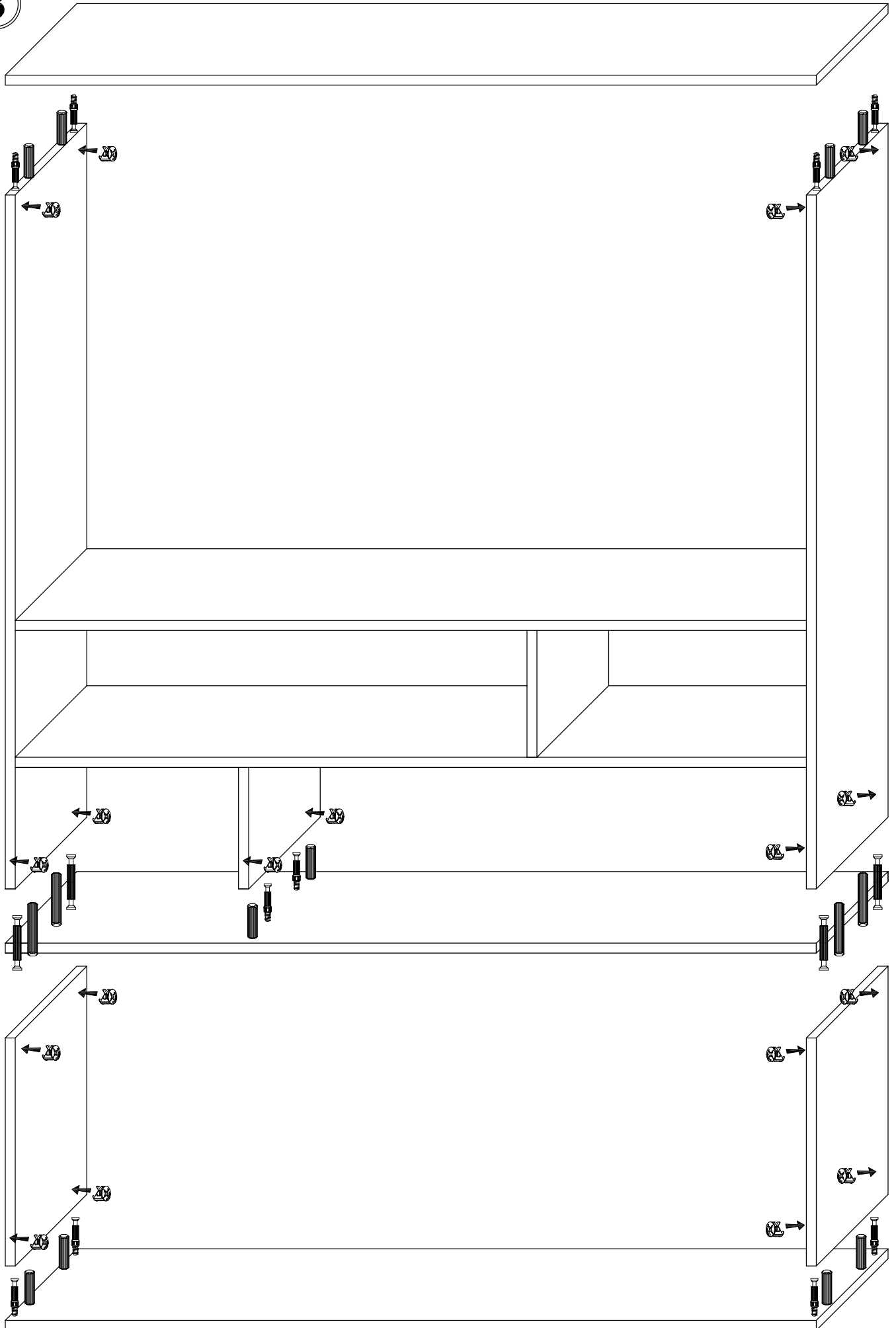

4

