

Nr 8
F12 x5
P13 3,5x13 x20

J20 L=818 mm x1

Nr 6
S3 3,5x13 x4
P3 3,0x13 x8

E2 6x11 x4

E1 6x8 x4

R25 L-500 mm x2L/2R

Nr 7
F7 x2

S12 3,0x13 x2

Nr 3
J23 x10
P2 3x20 x18

Nr 4
J11 x1

P13 3,5x13 mm x2

Nr 5
UG20 x4

A2 M4x20 x8

Nr 1
B1 ϕ 8x28 x28

B2 ϕ 8x50 x2

L1 x1

M1 ϕ 15x12mm x33

T1 5x39mm x33

C2 x25

F15 x9

Nr 2
Y17 x8

D17 H6 x8

E3 6,3x13 x16

S8 4x13 x16

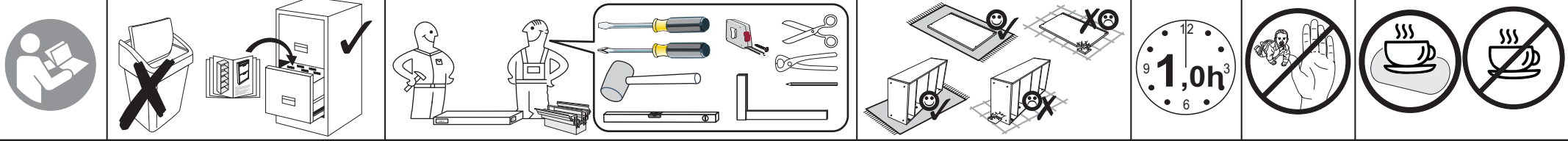

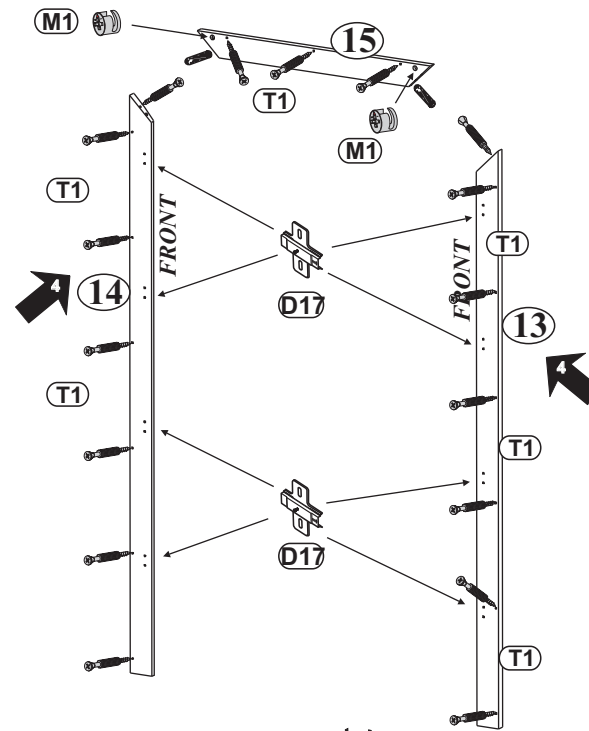
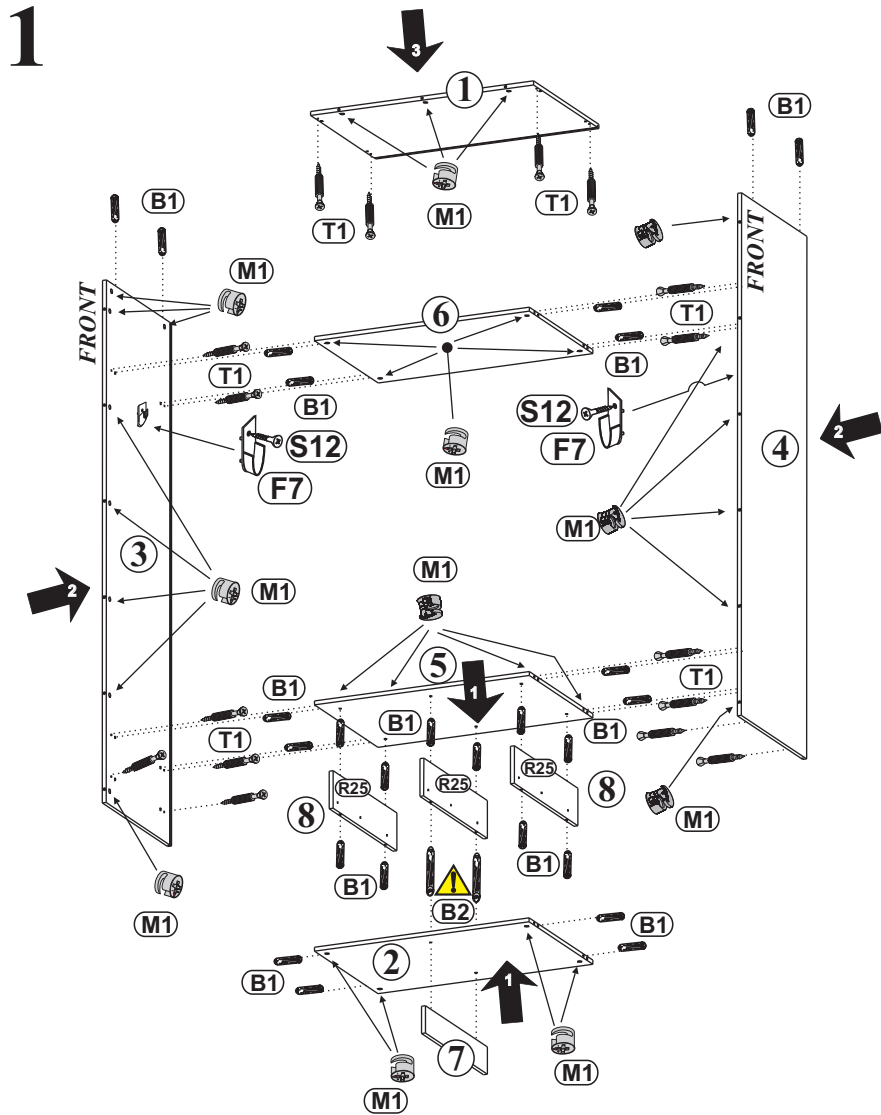

B1 φ 8x28 x28	Y17 x8
B2 φ 8x50 x2	D17 H6 x8
M1 φ 15x12mm x33	E3 6,3x13 x16
T1 5x39mm x33	S8 4x13 x16
	F7 x2
	S12 3,0x13 x2

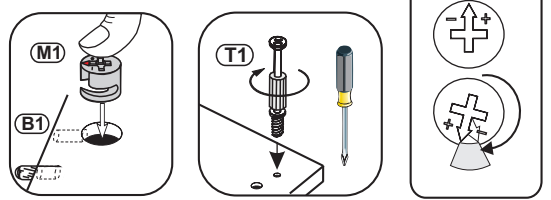
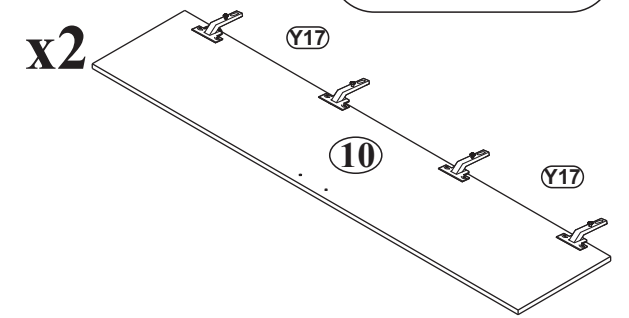
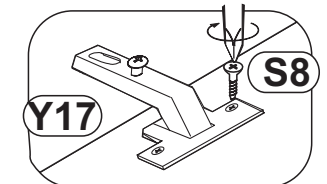
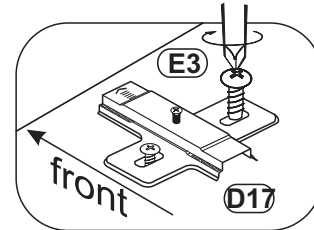

2

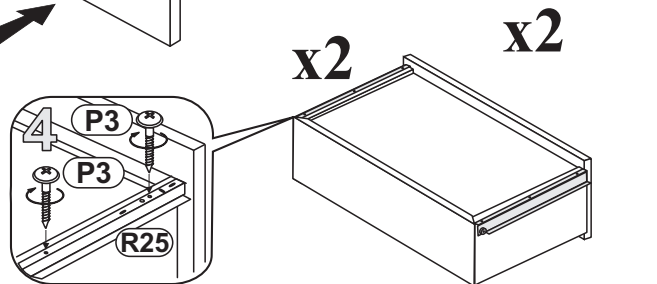
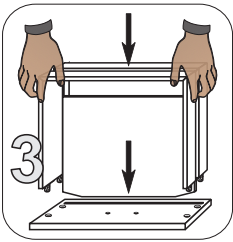
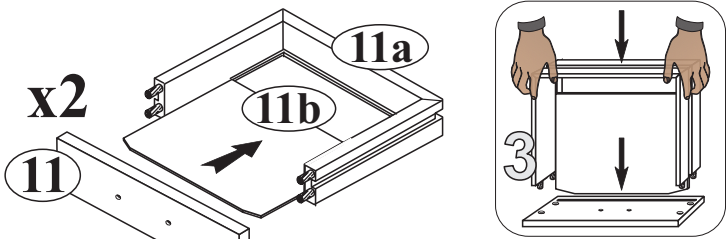
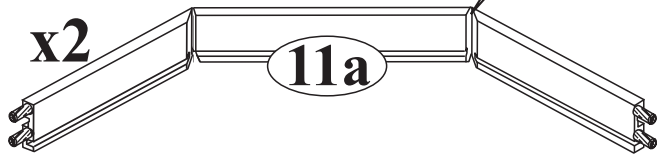
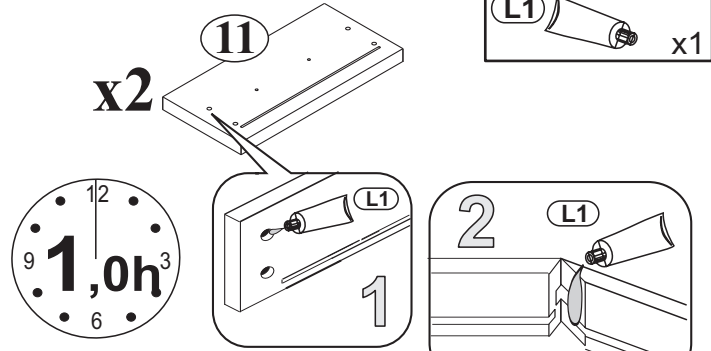
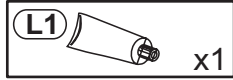
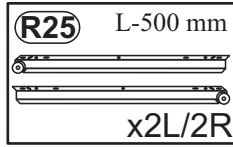
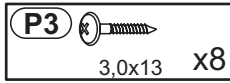

3

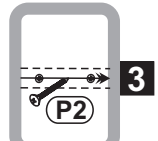
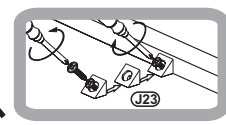
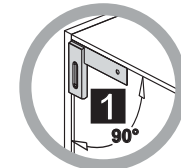
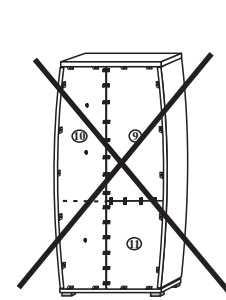
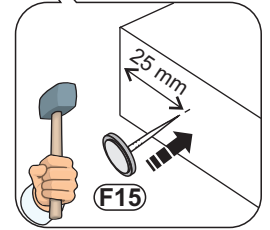
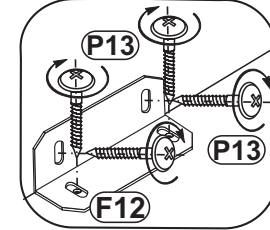
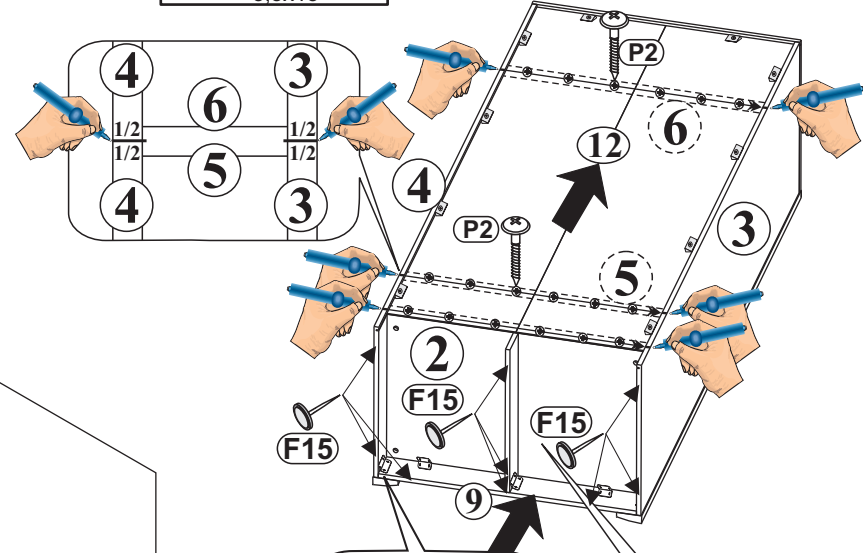
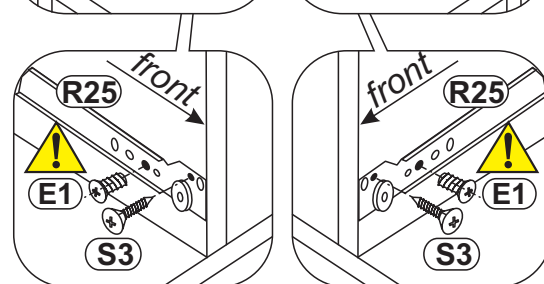
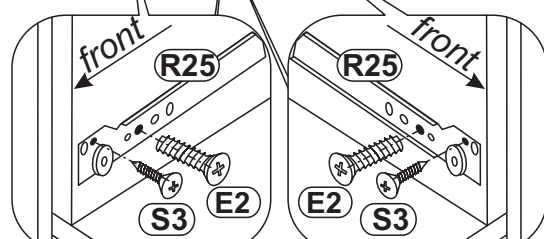
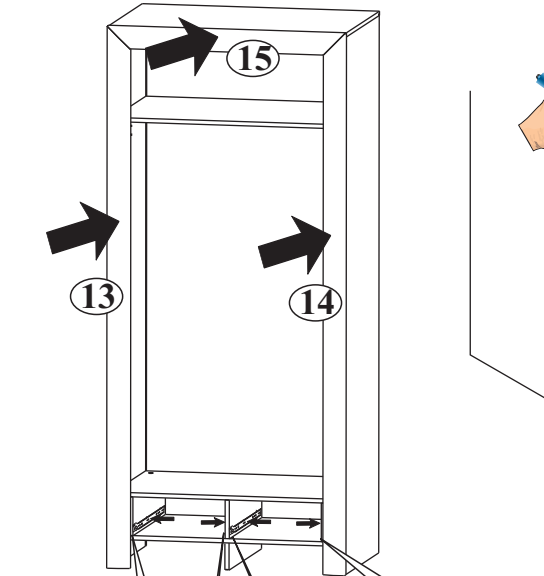
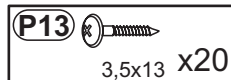
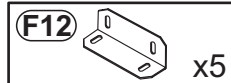
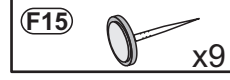
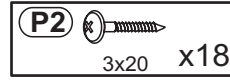
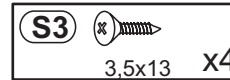
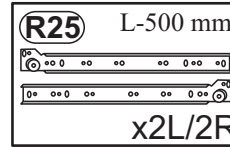
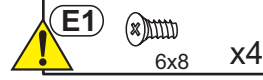
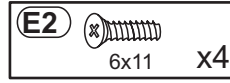
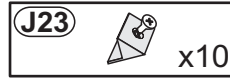

Modellname: **SYCYLIA**
Nazwa modelu:

Modellreihe: **P9 -- SY 72**
Numer modelu:

Type: **72**
Typ:

Blatt Nr **4** von: **4**
Strona z:

4

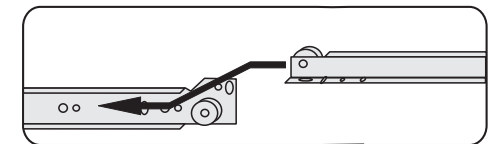
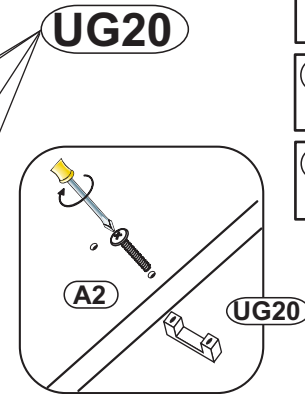
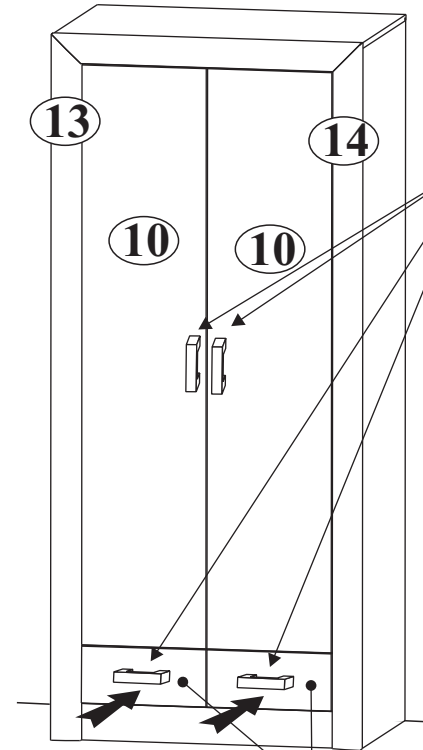
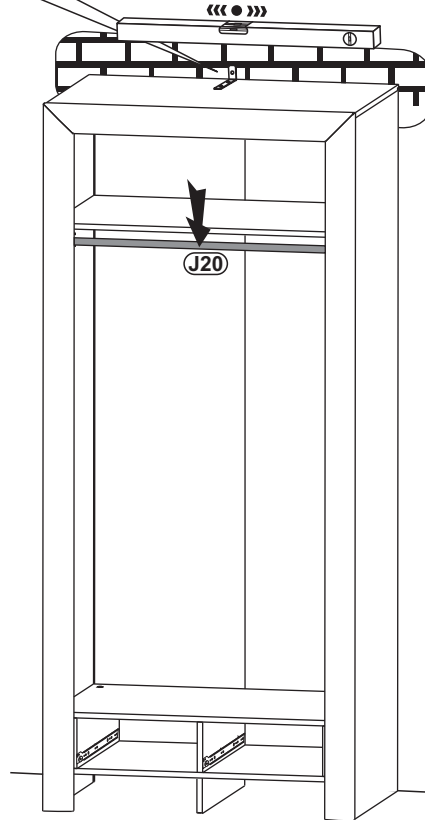
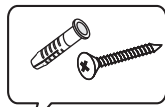
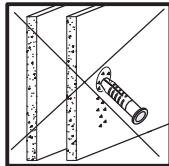
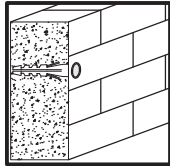
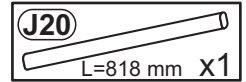
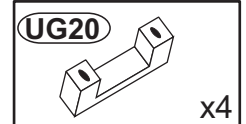
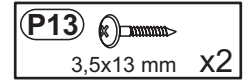
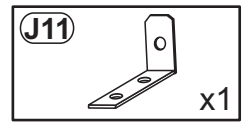
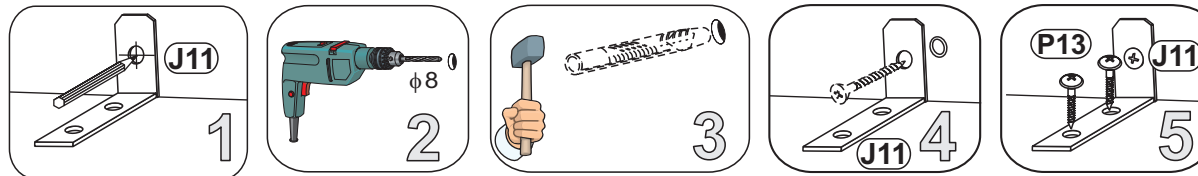
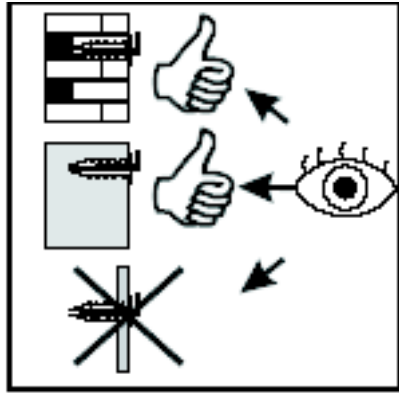

11

