

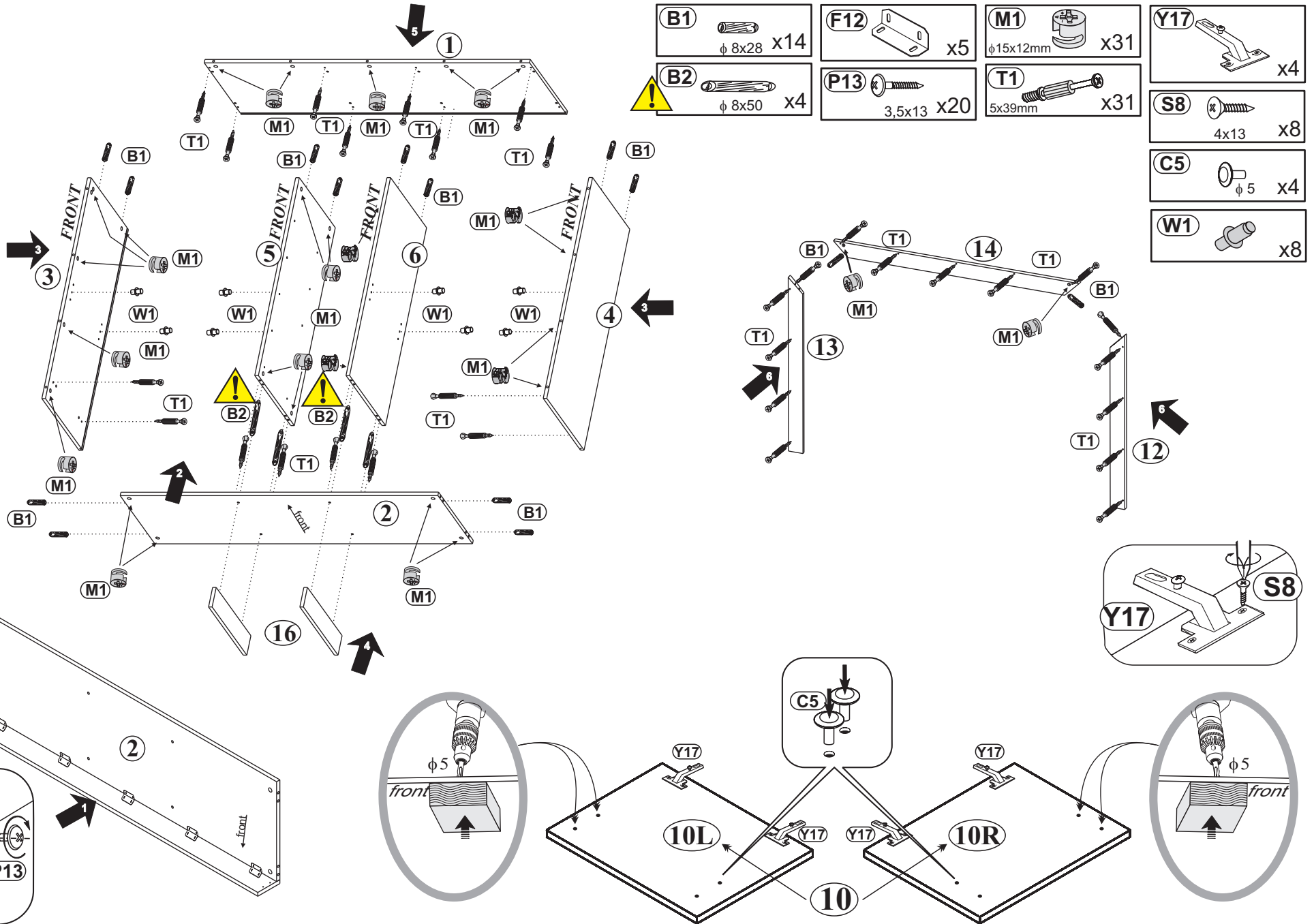

1

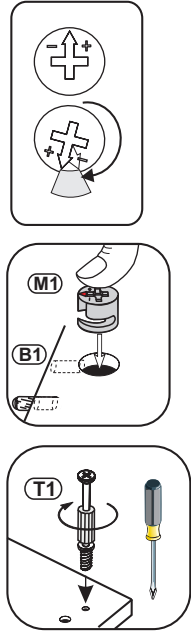



B1  $\phi 8 \times 28$ x14

F12  x5

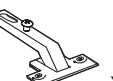
M1  $\phi 15 \times 12 \text{mm}$ x31

Y17  x4

B2  $\phi 8 \times 50$ x4

P13  3,5x13 x20

T1  5x39mm x31

S8  4x13 x8

C5  $\phi 5$ x4

W1  x8

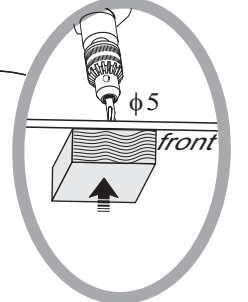
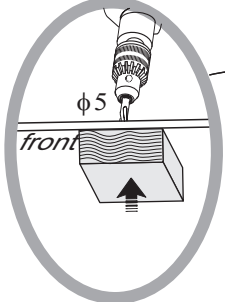
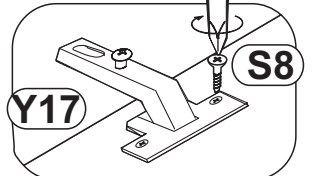

2

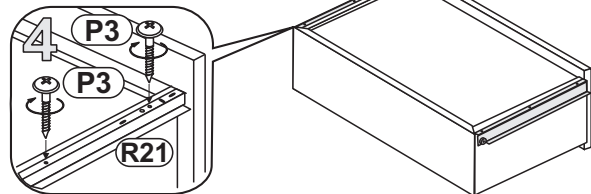
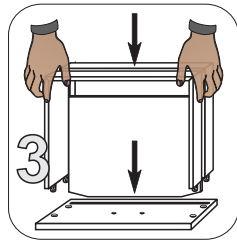
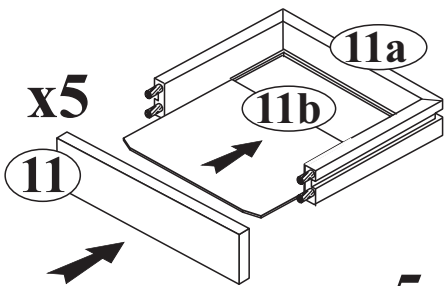
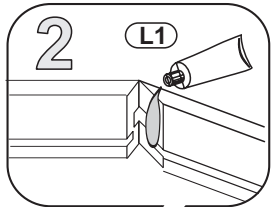
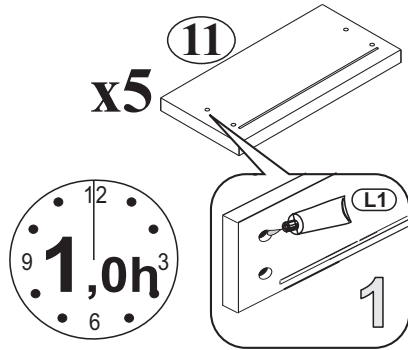
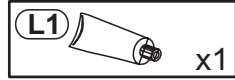
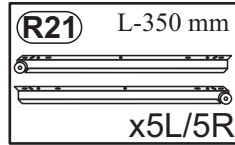
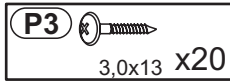

3

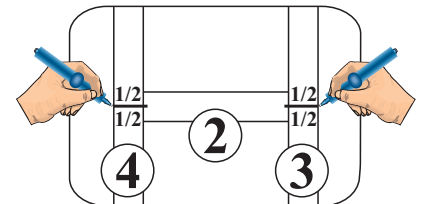
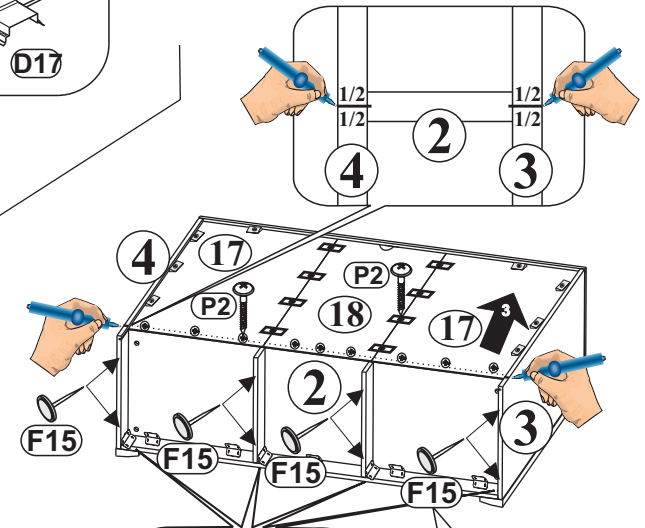
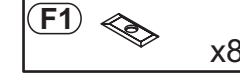
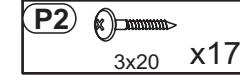
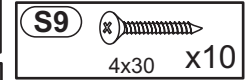
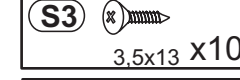
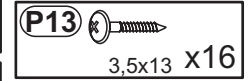
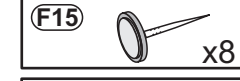
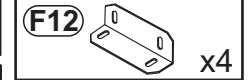
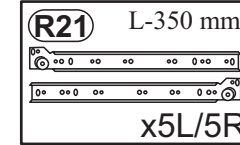
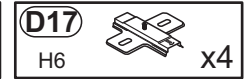
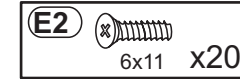
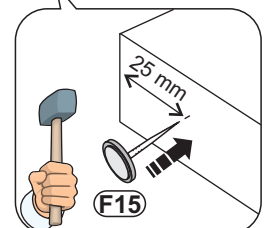
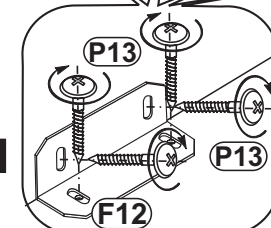
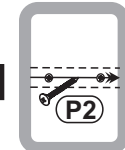
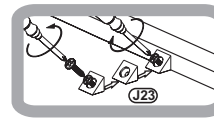
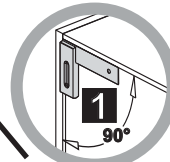
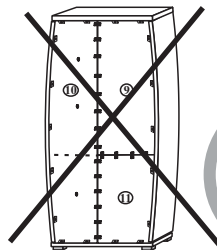
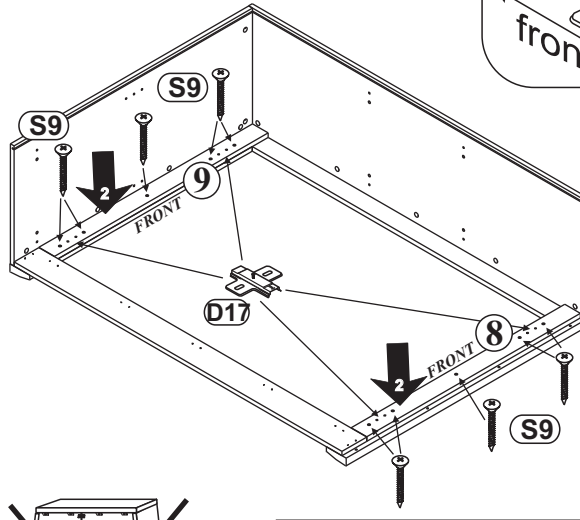
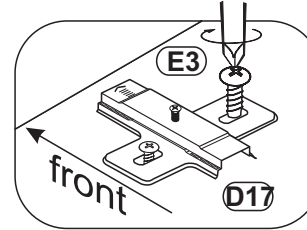
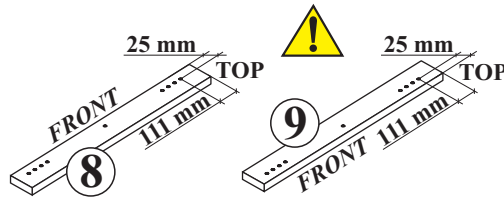
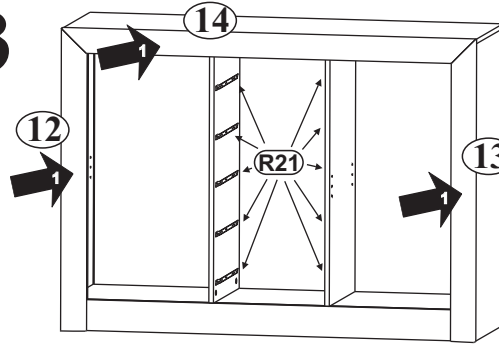

4

