

**1**

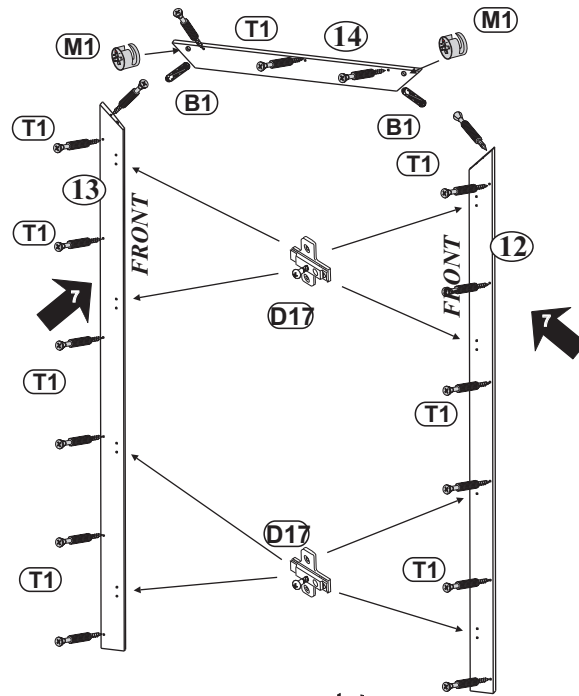

<b>B1</b>	$\phi 8 \times 28$ x16	<b>Y17</b>	x8
<b>B2</b>	$\phi 8 \times 50$ x2	<b>D17</b>	H6 x8
<b>M1</b>	$\phi 15 \times 12 \text{mm}$ x33	<b>E3</b>	6,3x13 x16
<b>T1</b>	5x39mm x33	<b>S8</b>	4x13 x16
<b>F12</b>	x2	<b>W1</b>	x12
<b>P13</b>	3,5x13 x8	<b>W2</b>	x16

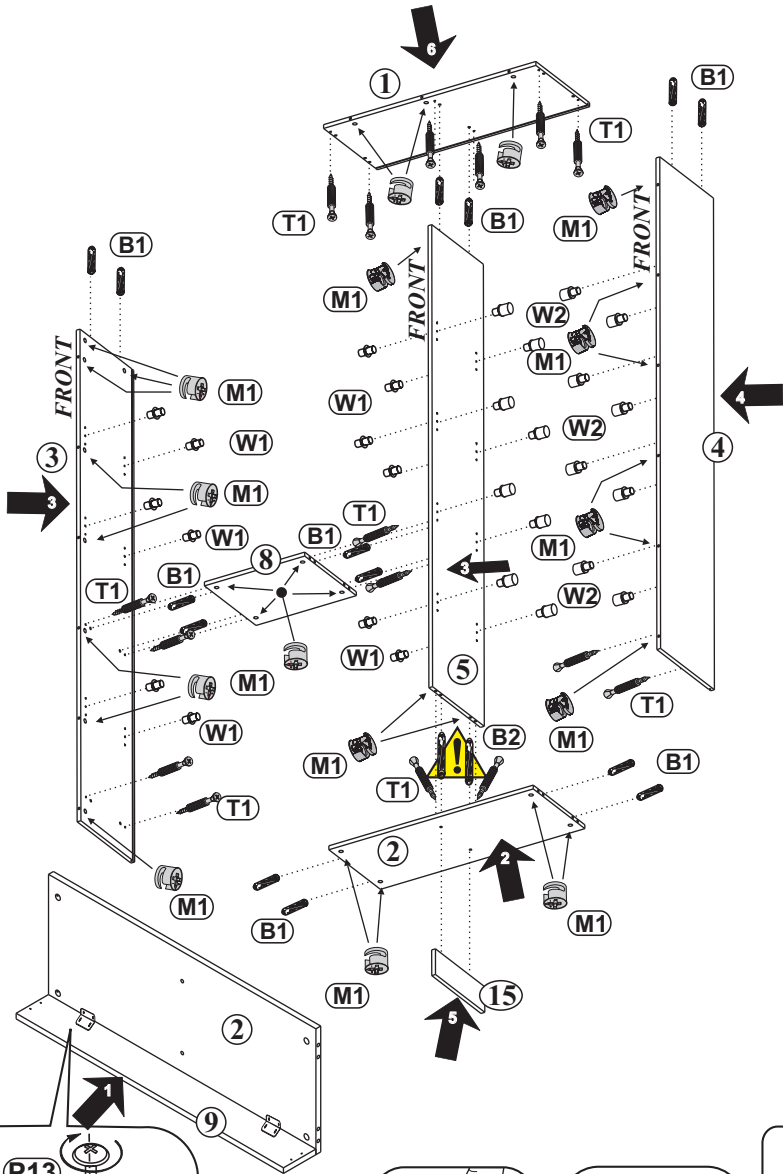
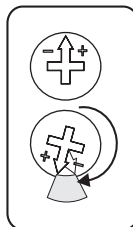
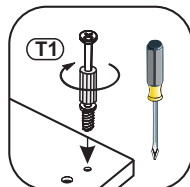
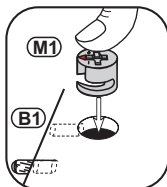
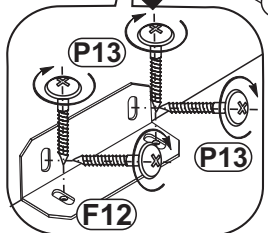
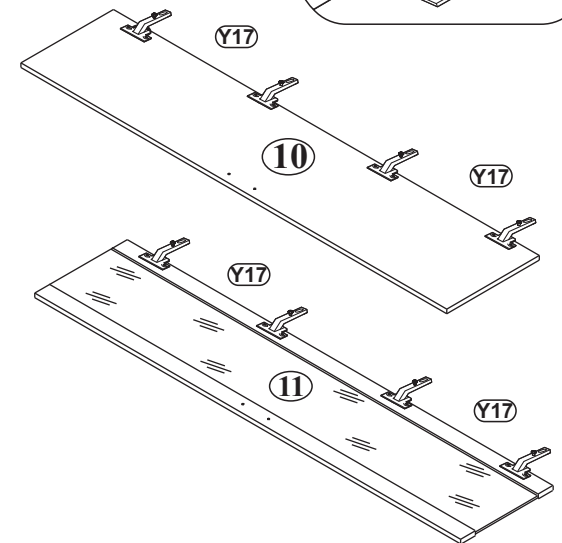
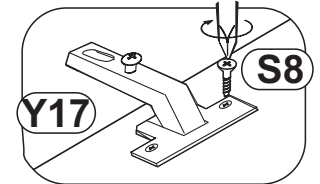
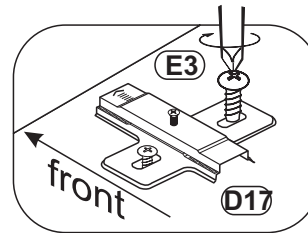

**2**

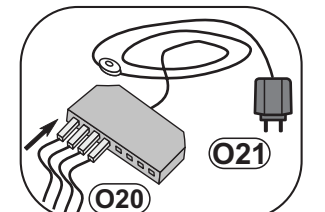
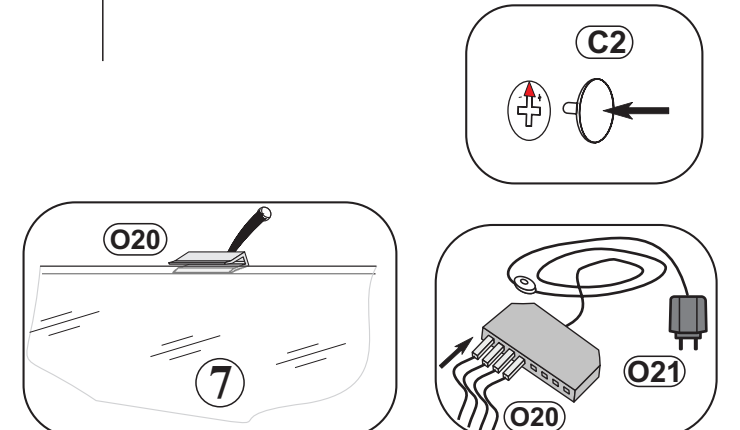
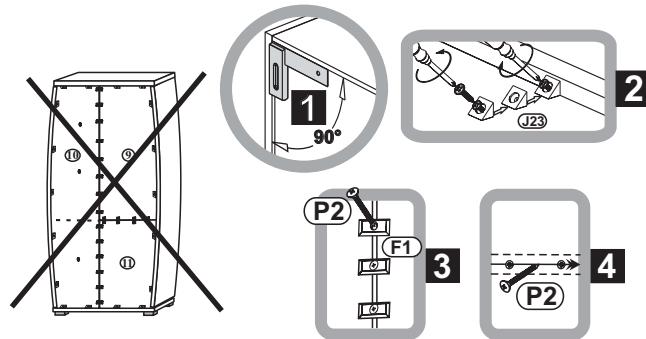
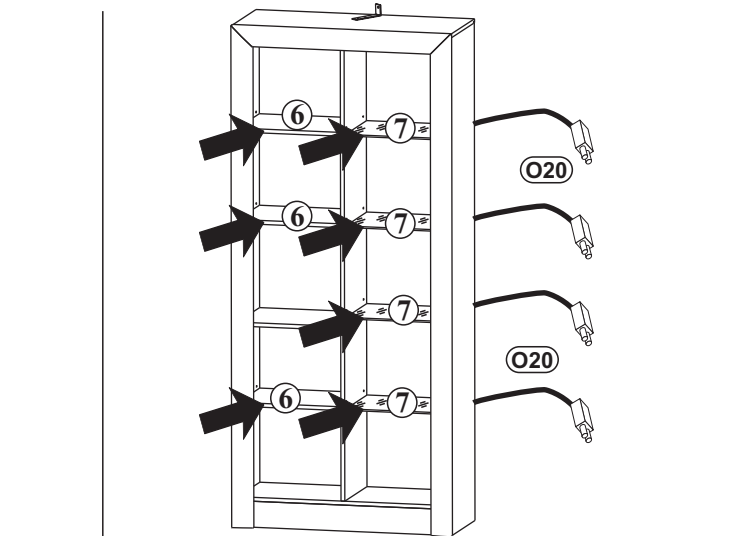
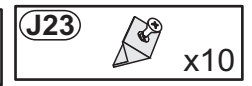
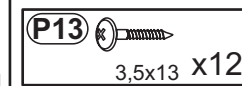
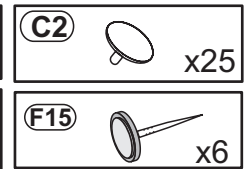
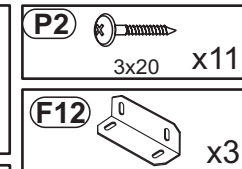
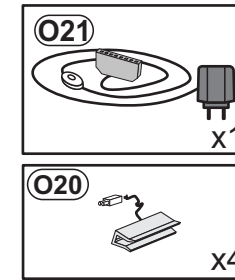
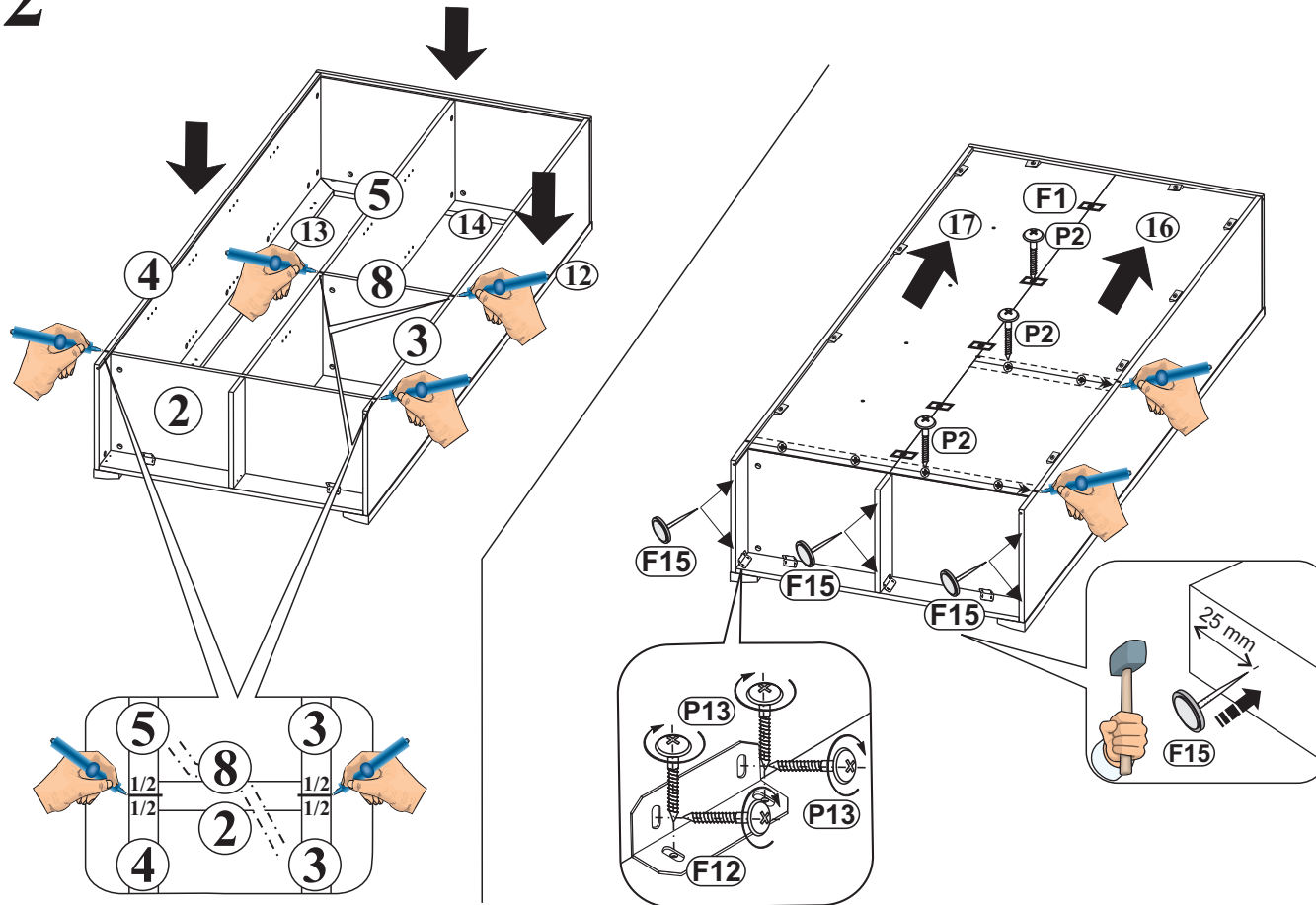

Modellname: **SYCYLIA**  
Nazwa modelu:

Modellreihe: **P9 -- SY22**  
Numer modelu:

Type: **22**  
Typ:

Blatt Nr **4** von: **4**  
Strona z:

**3**

