

14

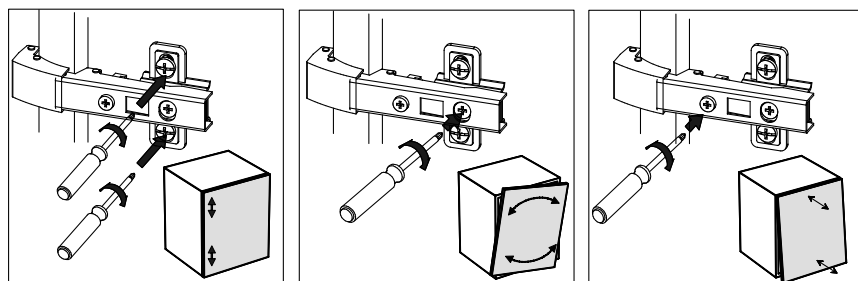

MODELL: Y5

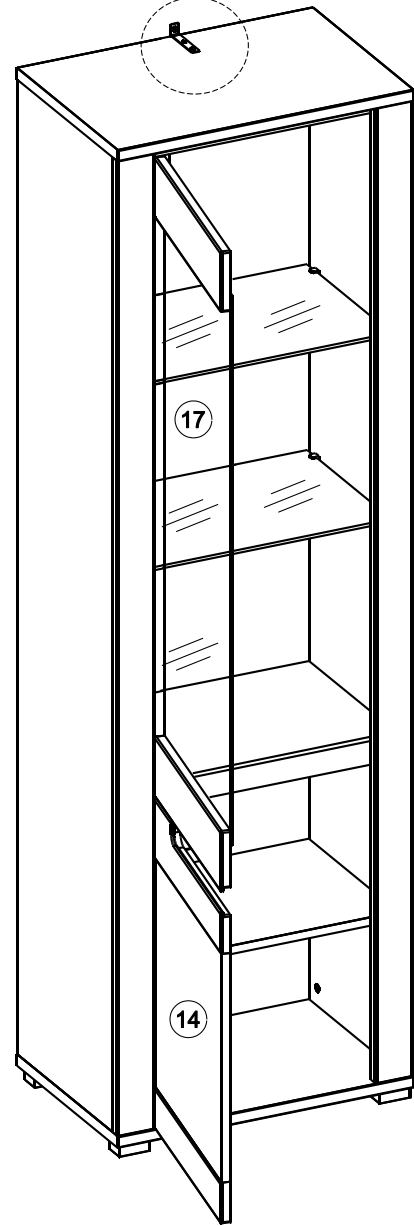
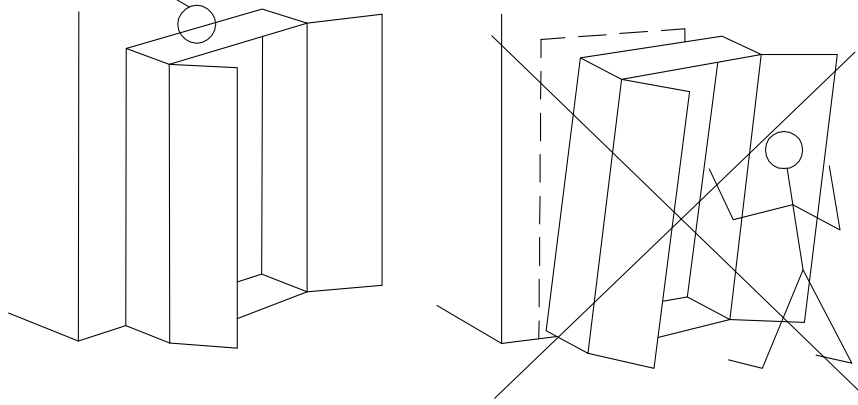
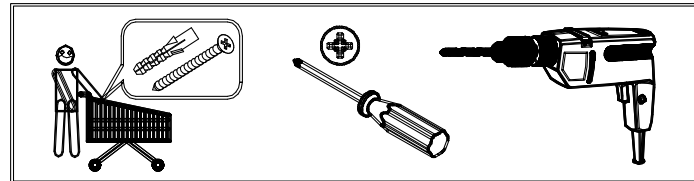
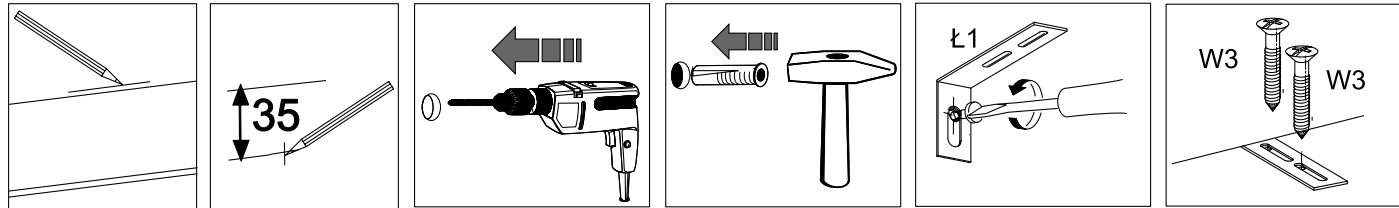
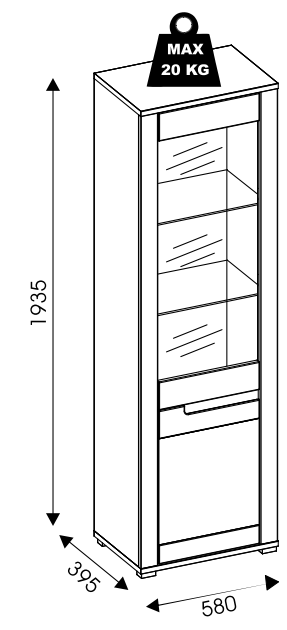
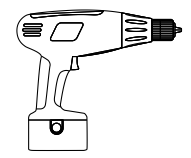
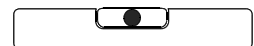
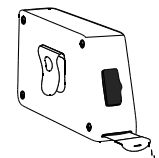
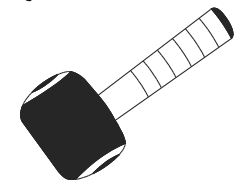
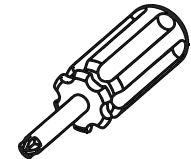
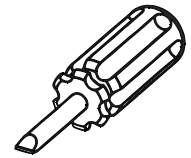
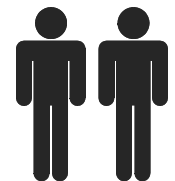

19	1885x562	2/3
18	539x330	1/3
17	1056x426	2/3
16	426x116	3/3
15	426x116	3/3
14	439x426	3/3
13	426x116	3/3
12	426x116	3/3
11	426x79	3/3
10	1871x74	2/3
9	1871x74	2/3
8	547x60	3/3
7	547x104	3/3
6	546x350	1/3
5	547x341	1/3
4	1871x375	2/3
3	1871x375	2/3
2	580x396	1/3
1	580x396	1/3

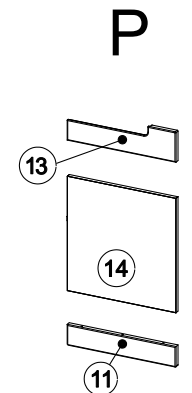
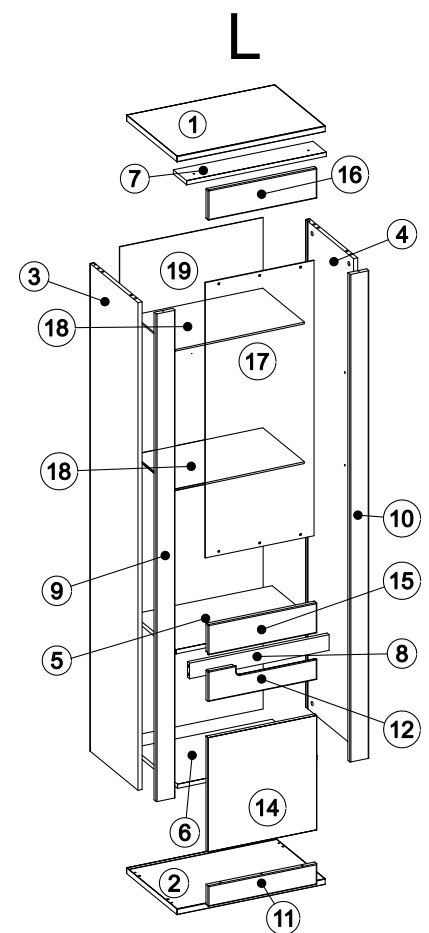
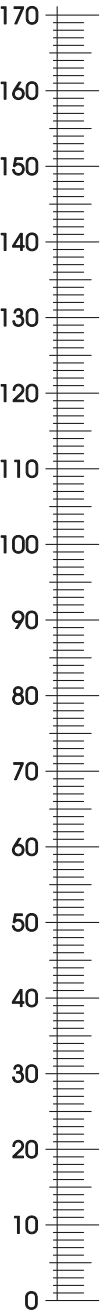

1x OPTION 2xNSP-3D/WW L1	1x L1	1x Z10	2x #14/863 ZN3	4x B1	2x #35 ZP1
6x 4x16 WP3	2x 4x30 WM1	6x TU1	14x ST1	40x 3.5x16 WP1	14x 3x20 W9
8x B2	4x N1	12x 3.5x16 W3	18x #20/863 ZN1	16x 8x30 K1	4x H=2 PR2
4x 18x #15/15 M1	18x DU232T T1	10x KM1	3x 2x20 G1	8x 5x20 E8	

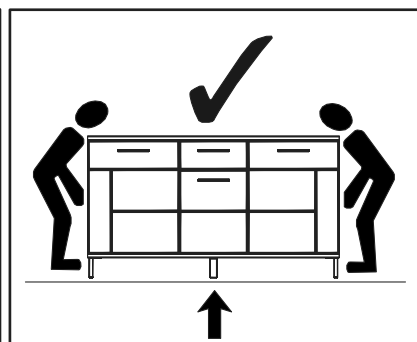
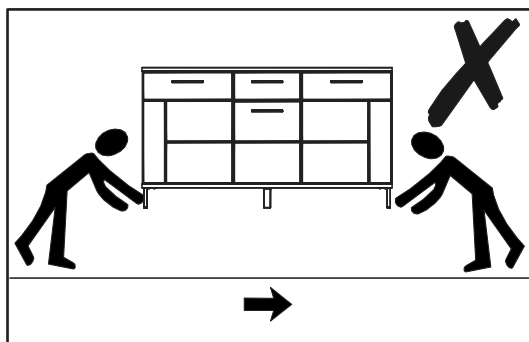
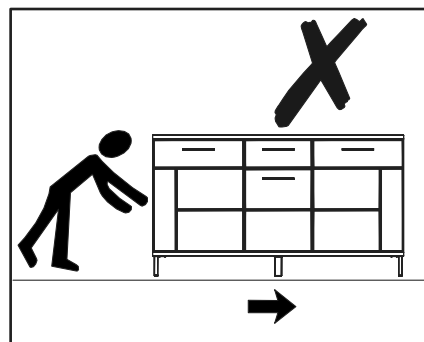
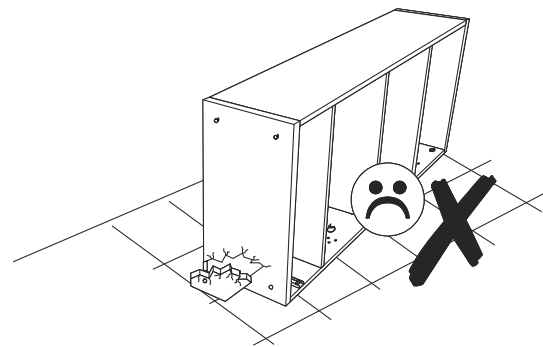
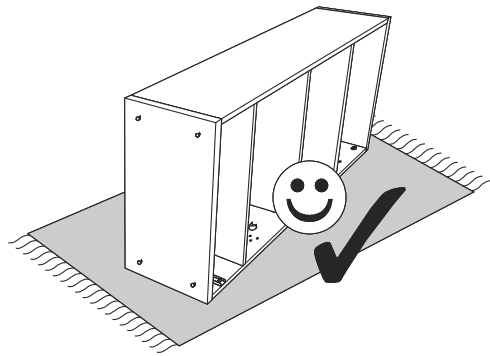
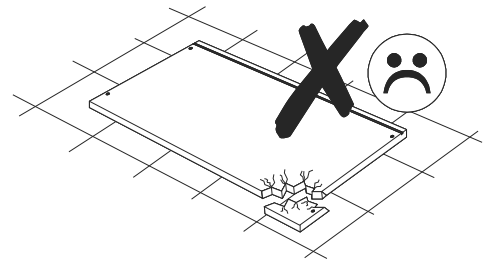
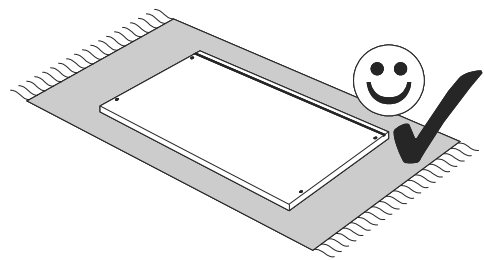
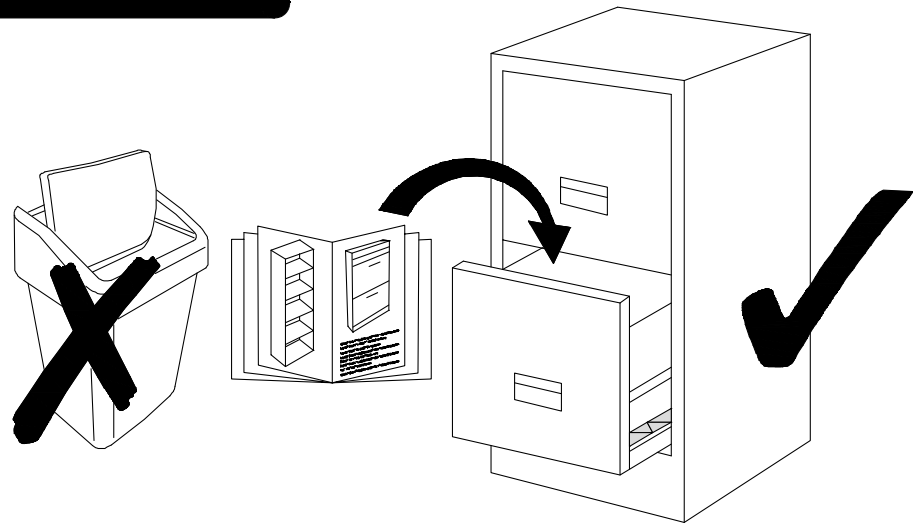

12

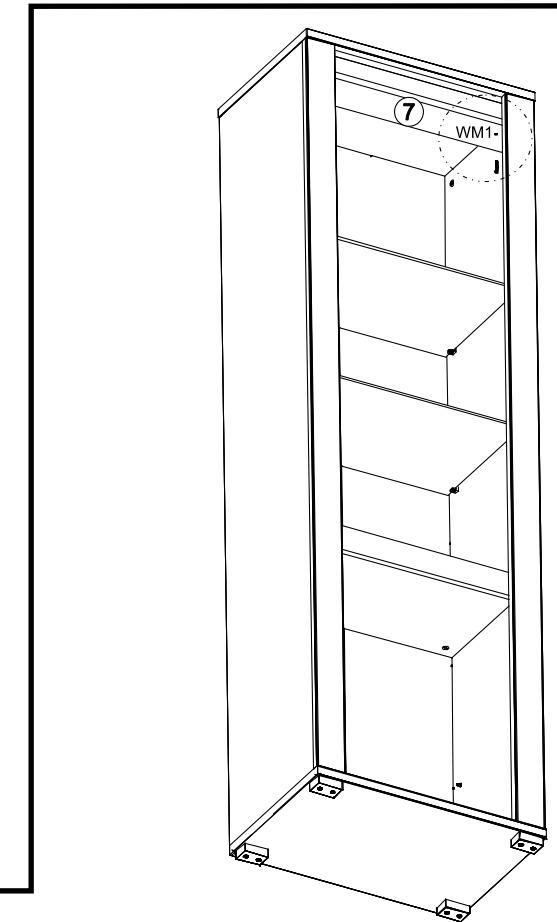
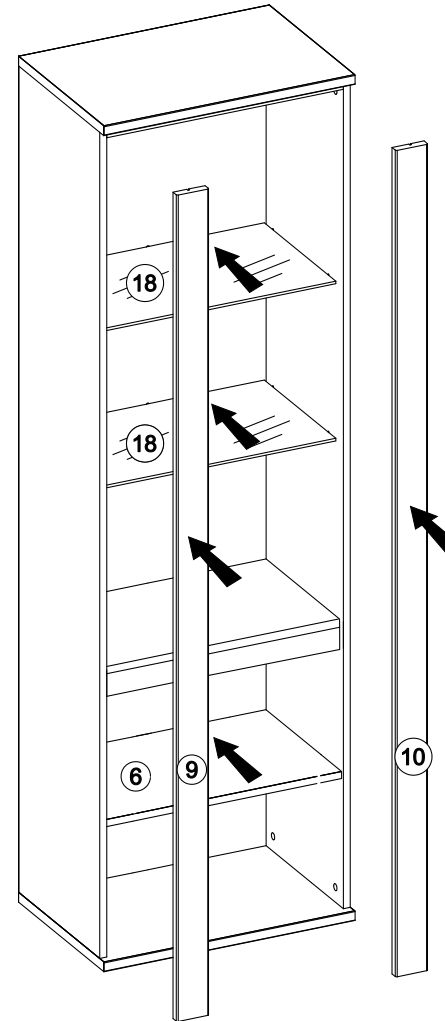
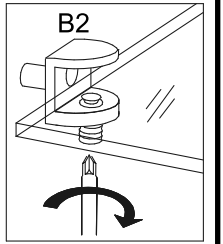
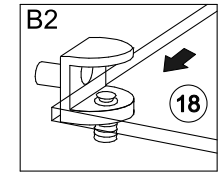
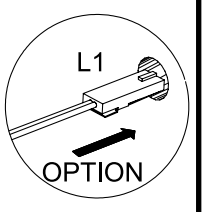
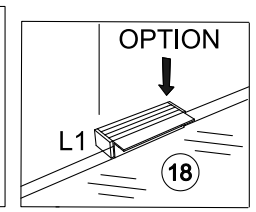
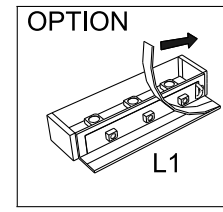
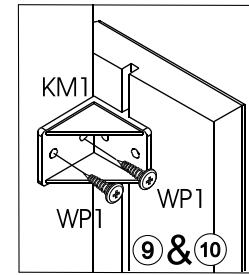

13

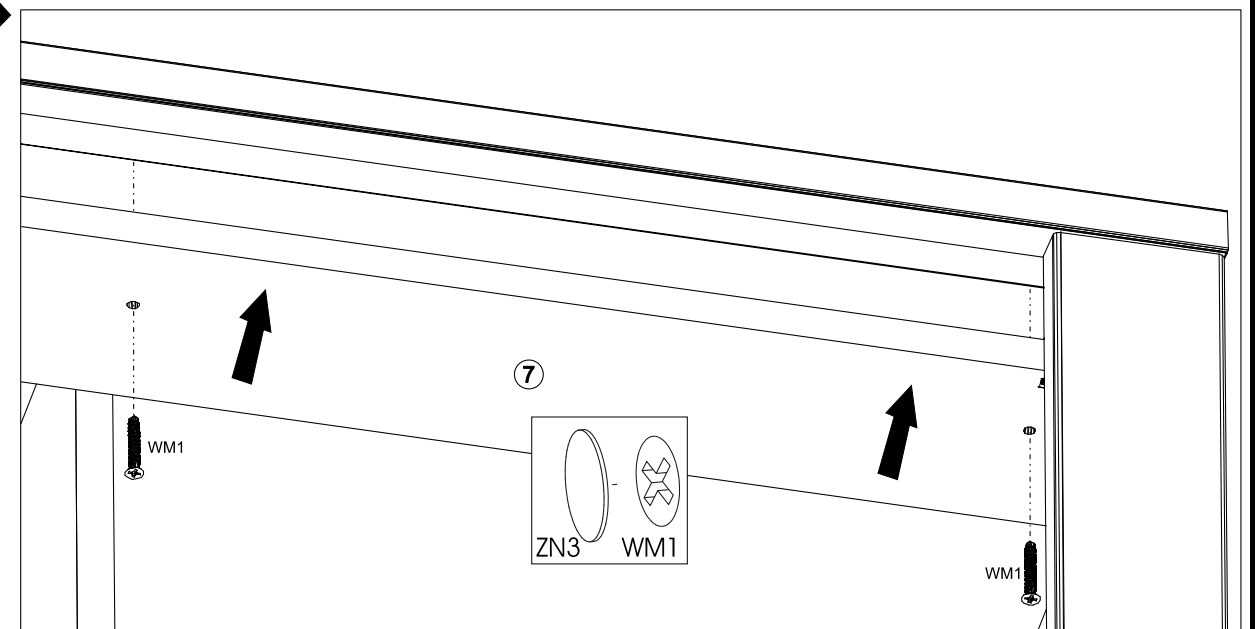

10▶

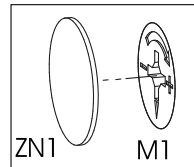
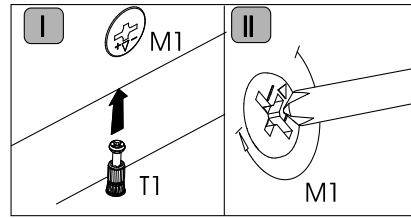
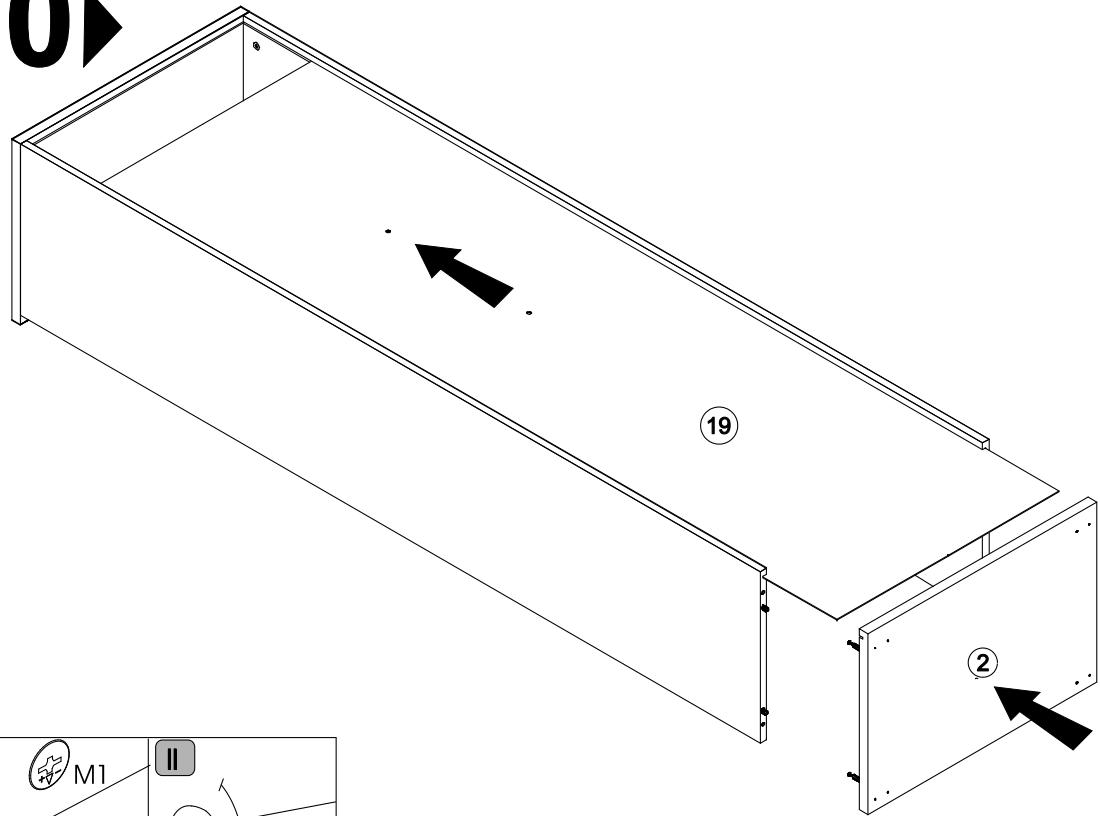

11▶

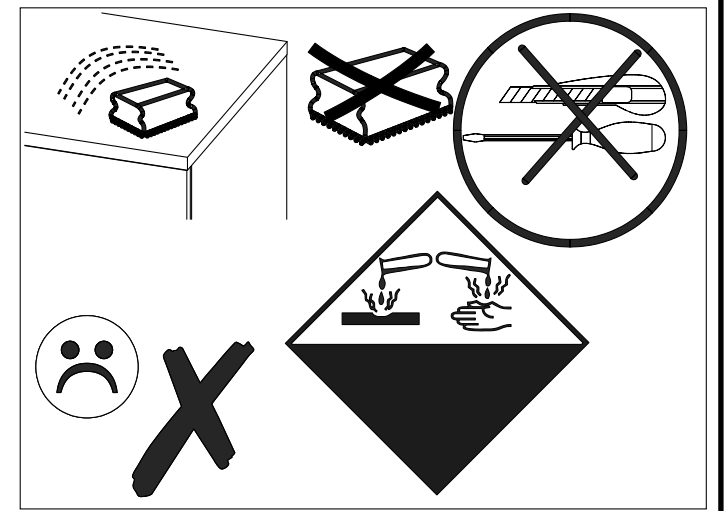
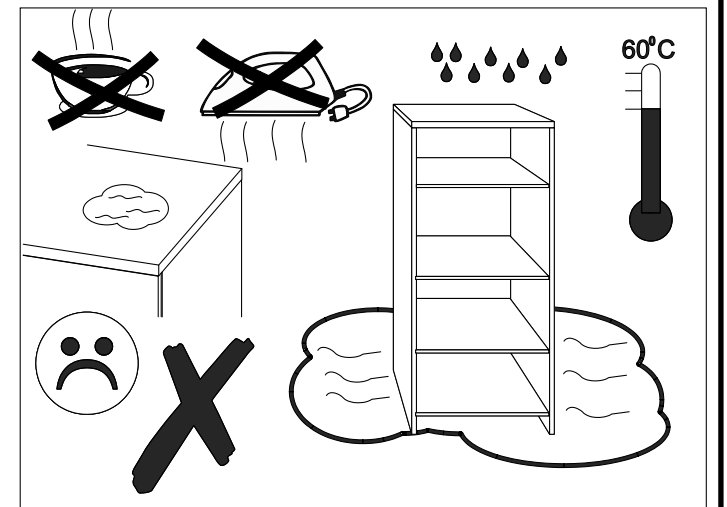
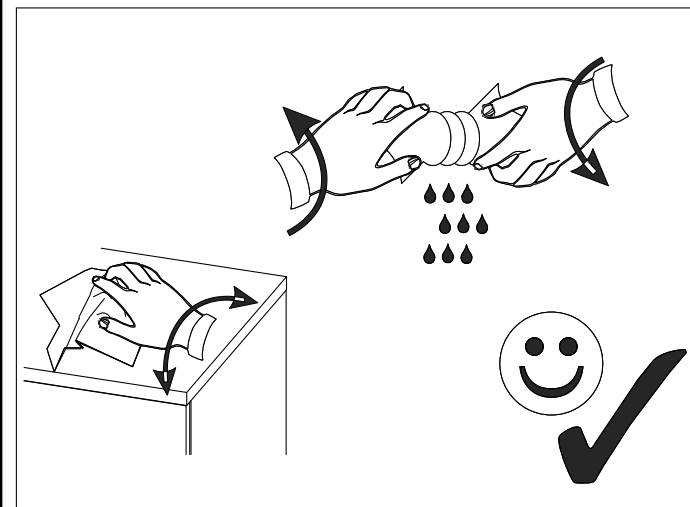
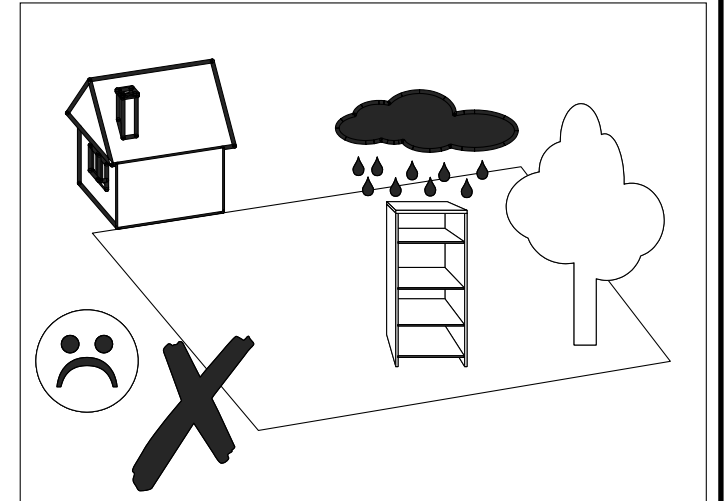
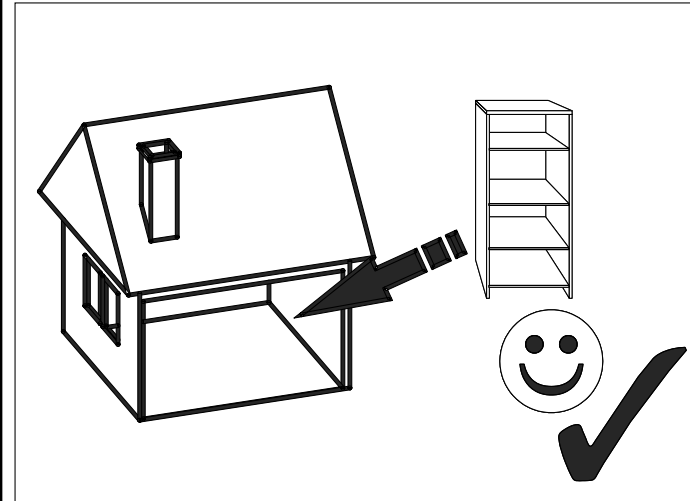
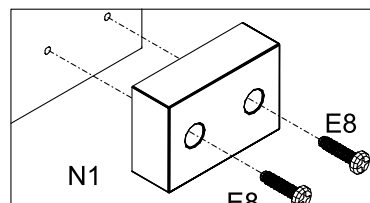
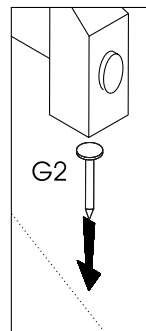
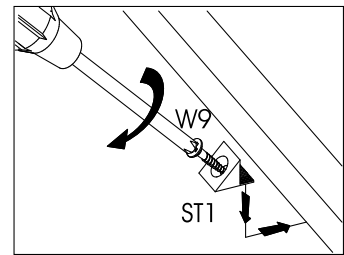
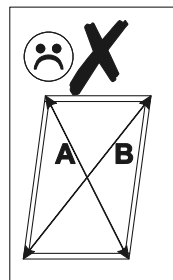
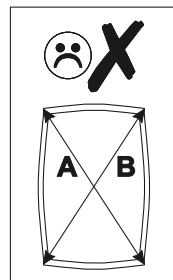
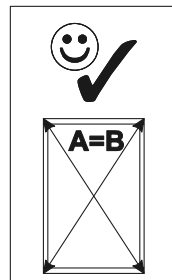
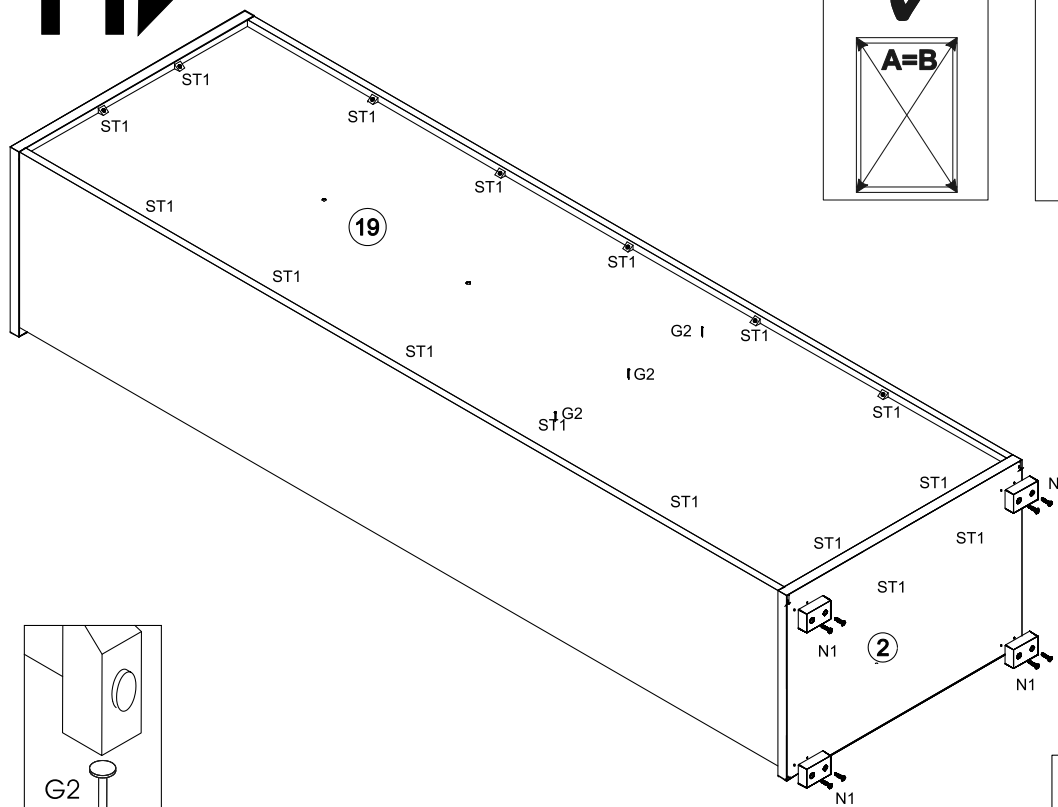

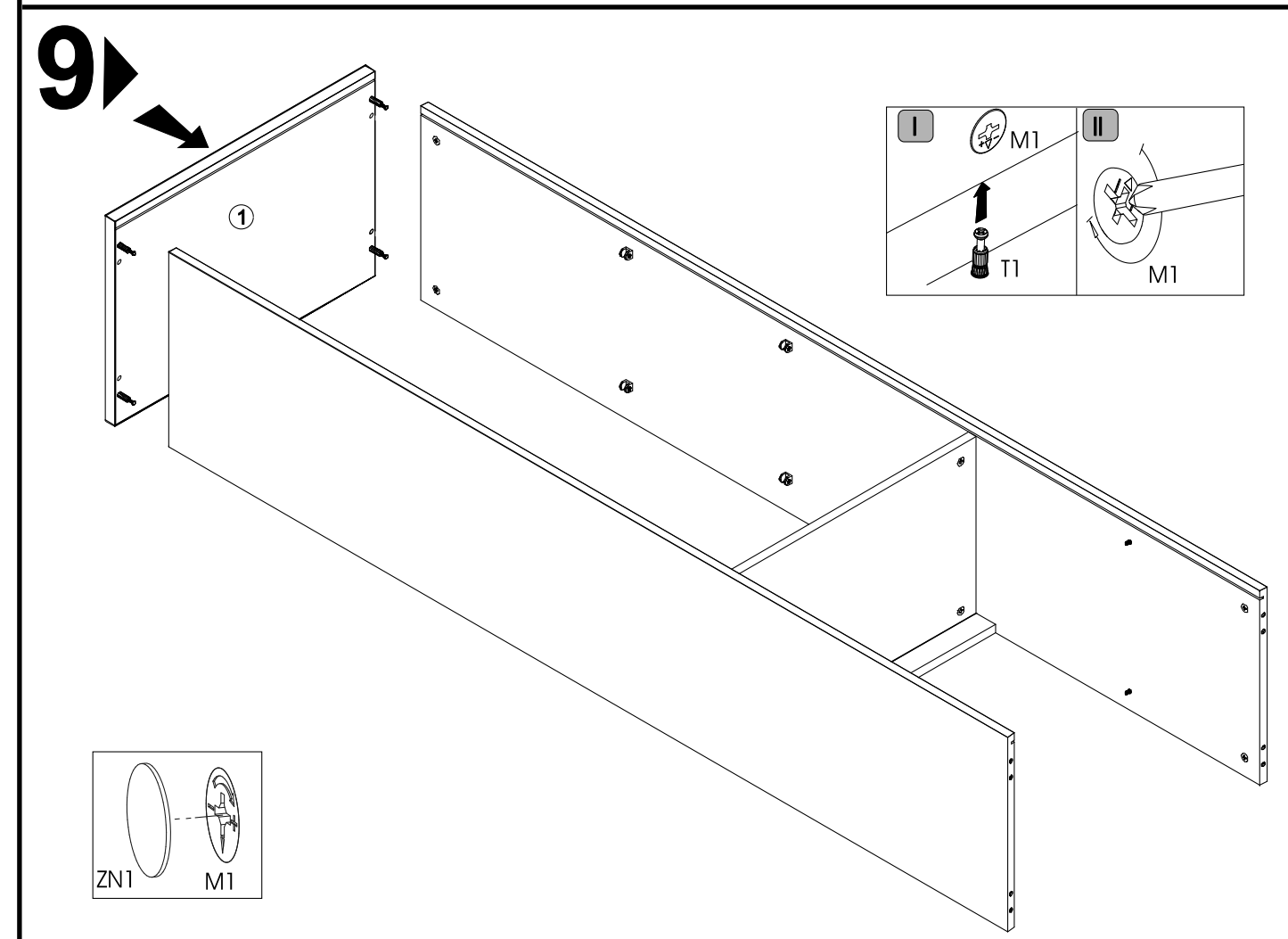
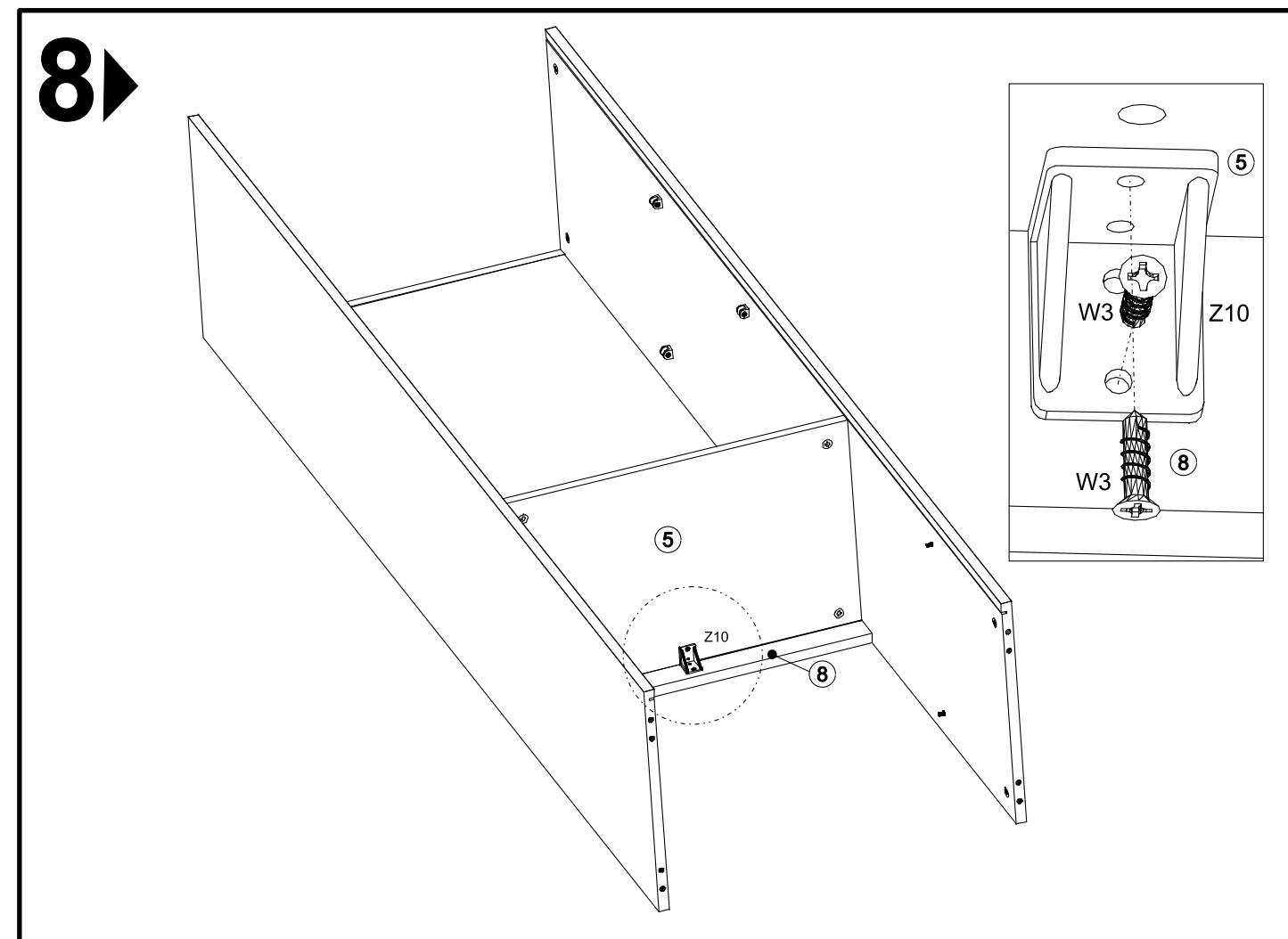
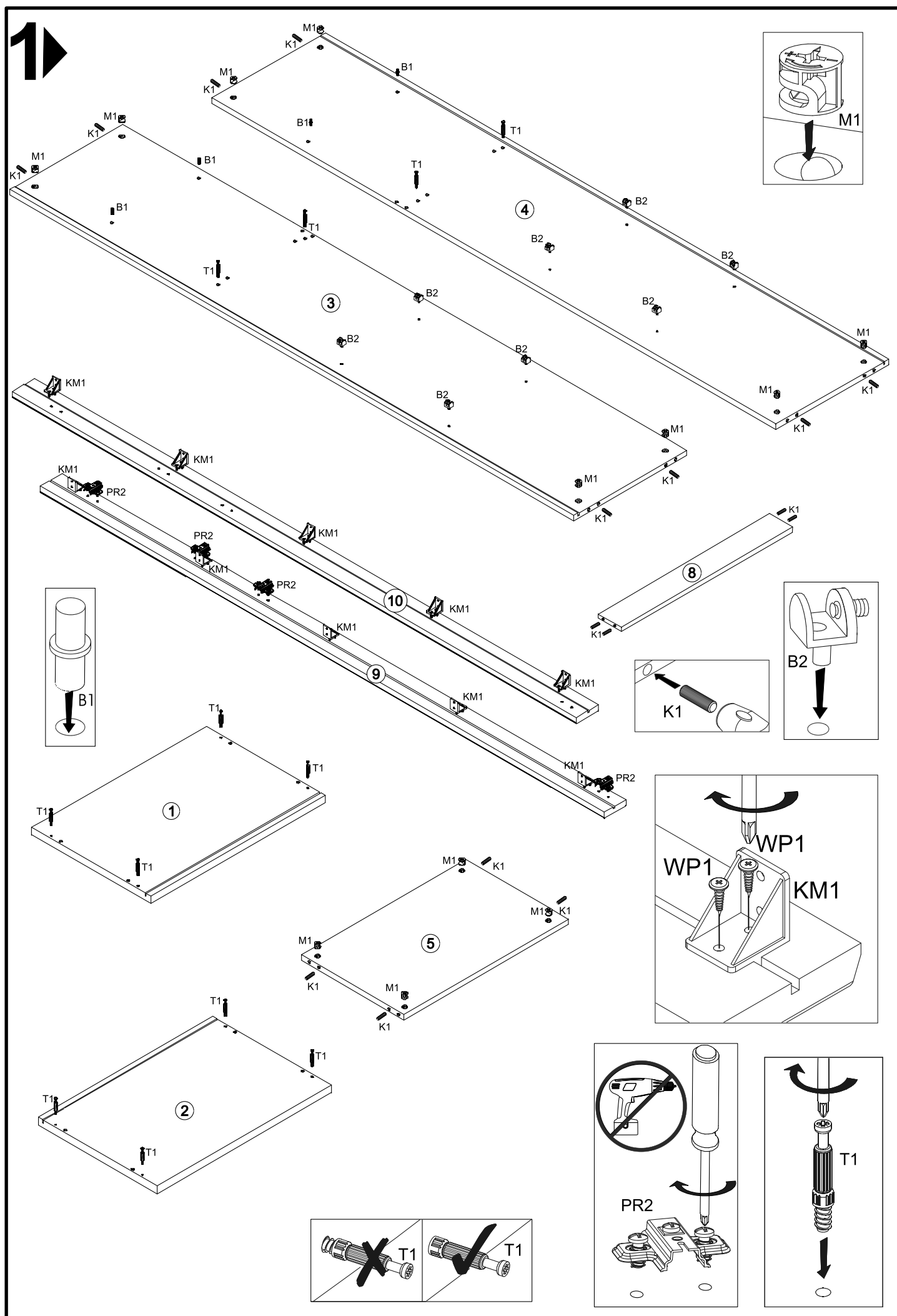

2

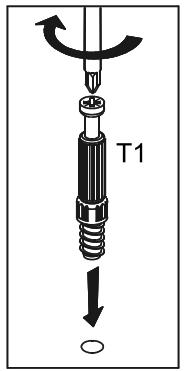
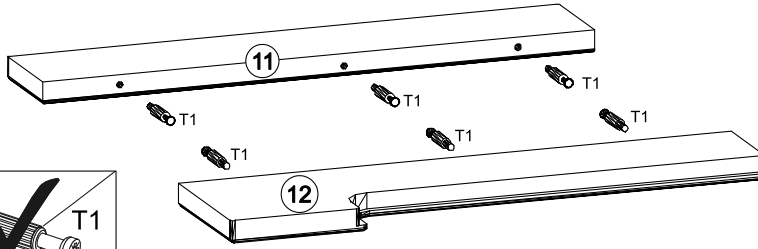
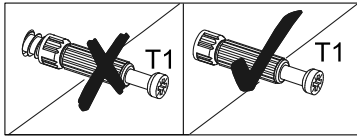

3

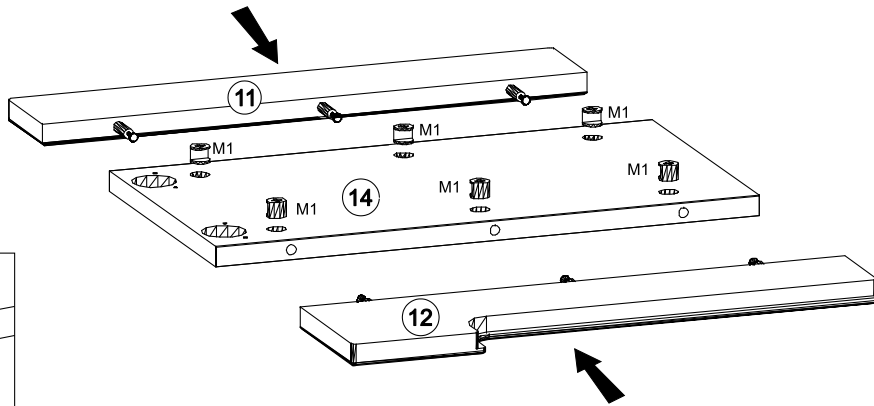
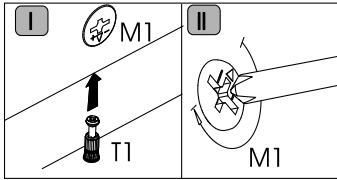
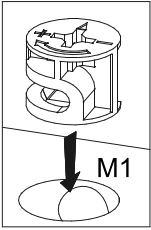

4

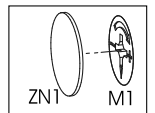
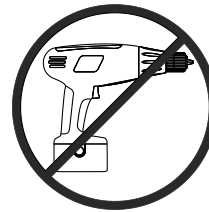
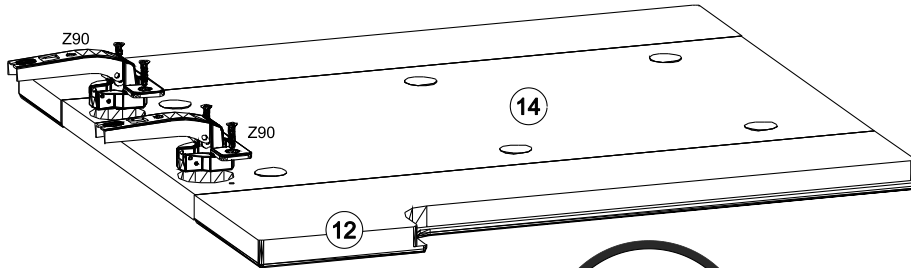
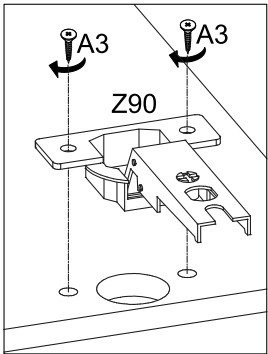

5

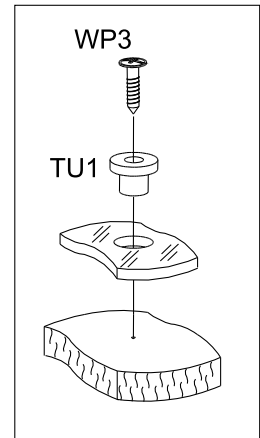
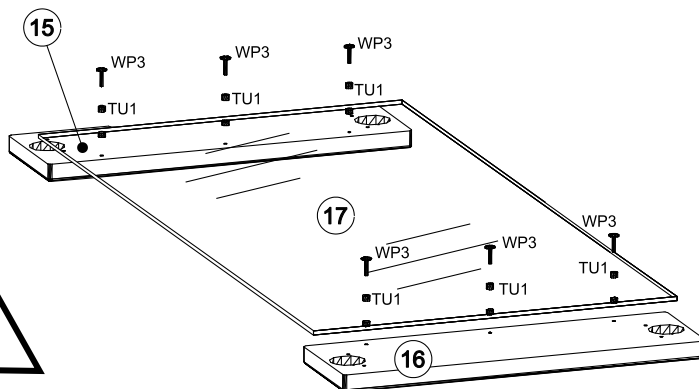
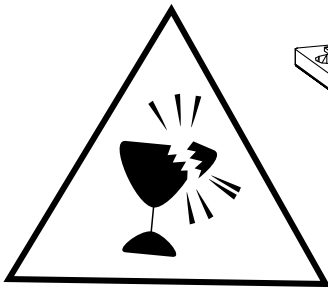

6

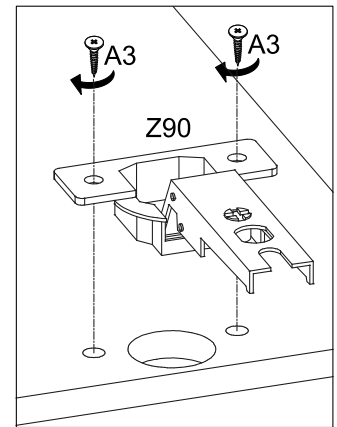
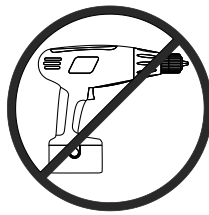
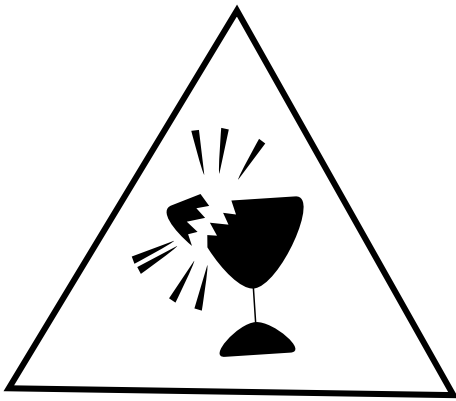
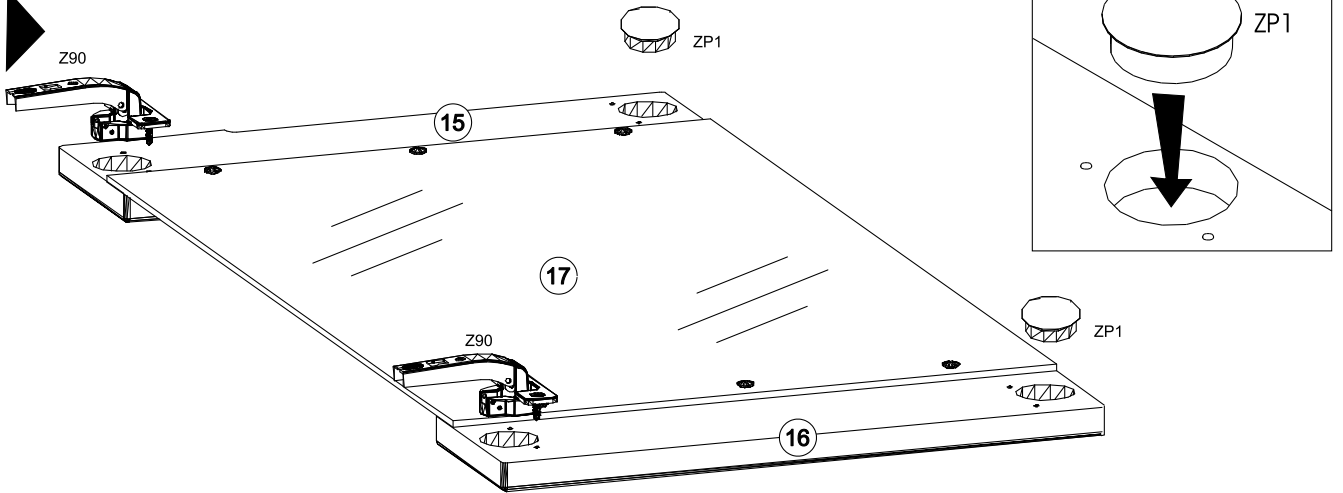

7

