



www.MLMEBLE.pl

GB

D

CZ

SK

RUS

LT

assembly instructions / montageanleitung / montážní návod / montážny návod / инструкции по монтажу / surinkimo instrukcija







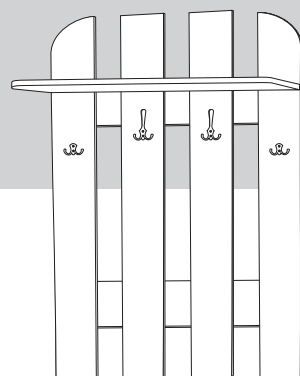

INSTRUKCJA MONTAŻU

W 70-01

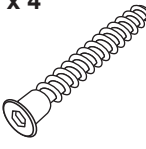
↑ 120 → 70 ↗ 24

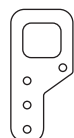
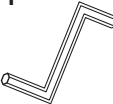
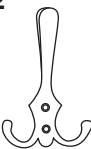

akcesoria / accessories / zubehör / příslušenství / príslušenstvo / аксессуары / furnitūra :



<p>x 4</p>  <p>KT 7/60</p>	<p>x 8</p>  <p>WT 3x16</p>	<p>x 16</p>  <p>WT 4x30</p>	<p>x 8</p>  <p>WT 3,5x20</p>	<p>x 2</p>  <p>ZA P90x37</p>	<p>x 1</p>  <p>kluczyk / key / schlüssel / klíč / kľúč / ключ / raktas</p>	<p>x 2</p>  <p>WK 3N</p>	<p>x 2</p>  <p>WK 2N</p>
---	---	--	---	---	---	---	---

do montażu potrzebne są:

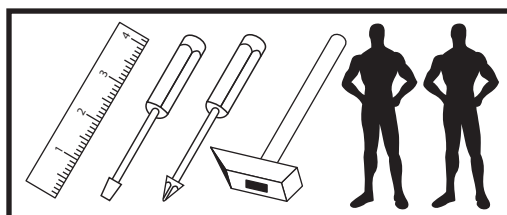
are needed for assembly:
sind erforderlich für die montage:
jsou potřebné pro montáž:
sú potrebné pre montáž:
которые необходимы для сборки:
Surinkimui reikės

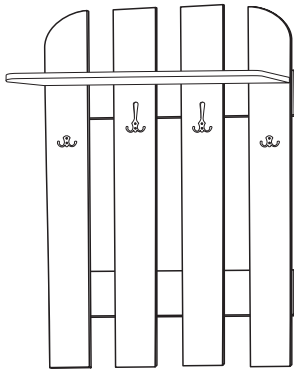



	CODE			
1	W7001_01	1200	130	1
2	W7001_02	654	196	1
3	W7001_03	660	100	2
4	W7001_04	1200	130	1
5	W7001_05	1200	130	2
6				
7				
8				
9				
10				

