

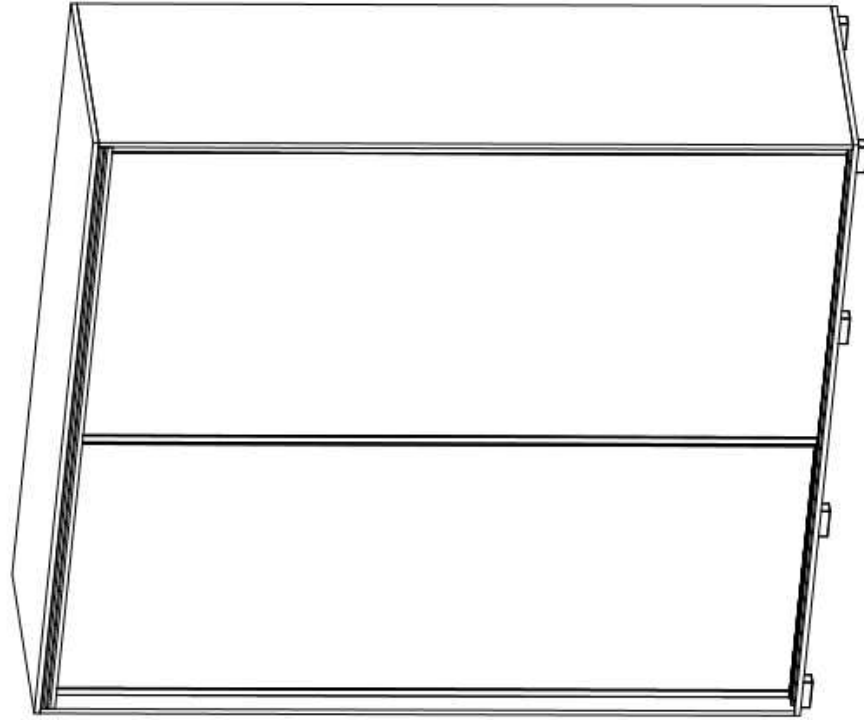

















Instrukcja montażu

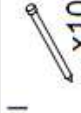

Szafa - SANDRA

(szer. 230cm, wys. 215cm, gł. 62cm)



A	 x34	B1	 x33	B2	 x33	B3	 x33
C	 x16	D	 x8	E	 x16	F	 x1
G	 x2	H	 x42	I	 x100	J	 x3
K	 x1	L	 x1	N2	 x4	O	 x3
M	 x4	N1	 x4				

Oznaczenie elementu	Nazwa	Ilość	Wymiary	
			szer.	wys.
1	Bok lewy	1	610	2090
2	Przegroda środkowa lewa	1	500	1769
3	Przegroda środkowa prawa	1	500	1769
4	Bok prawy	1	610	2090
5	Wieniec górny	1	500	2267
6	Wieniec	2	500	501
7	Biał górny	1	620	2301
8	Przegroda środkowa górna	1	500	305
9	Biał dolny	1	620	2301
10	Półka	4	500	501
11	Tył (plecy)	4	527	2290
12	Skrzydło drzwi	2	1150	2053

W PRZYPADKU ZAKUPU SZAFY Z KONTENERKIEM, JEGO MONTAŻU TRZEBA DOKONAĆ PRZED ZAMONTOWANIEM SZYNY DRZWI LUB TYLNEJ PŁYTY HDF (PLECÓW) KONTENER ZAWSZE UMIESZCZAMY PO ZEWNĘTRZNYCH STRONACH SZAFY.

Instrukcja montaży

1)

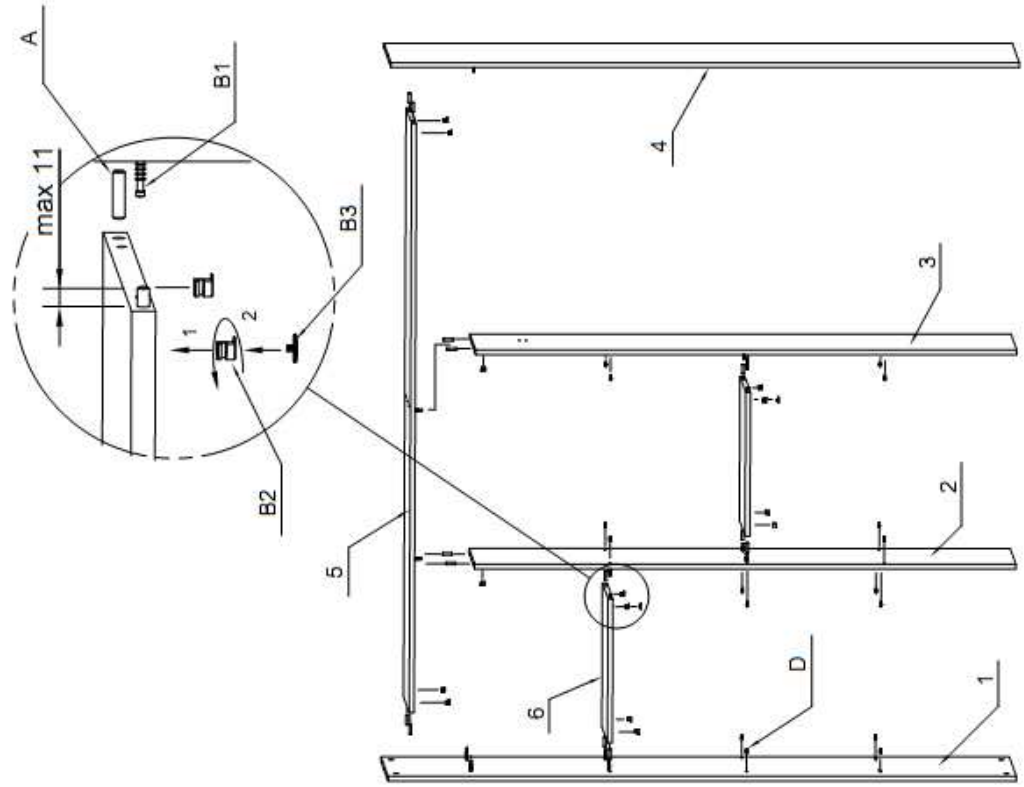

2)

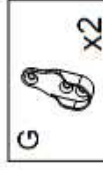
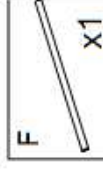
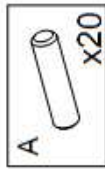
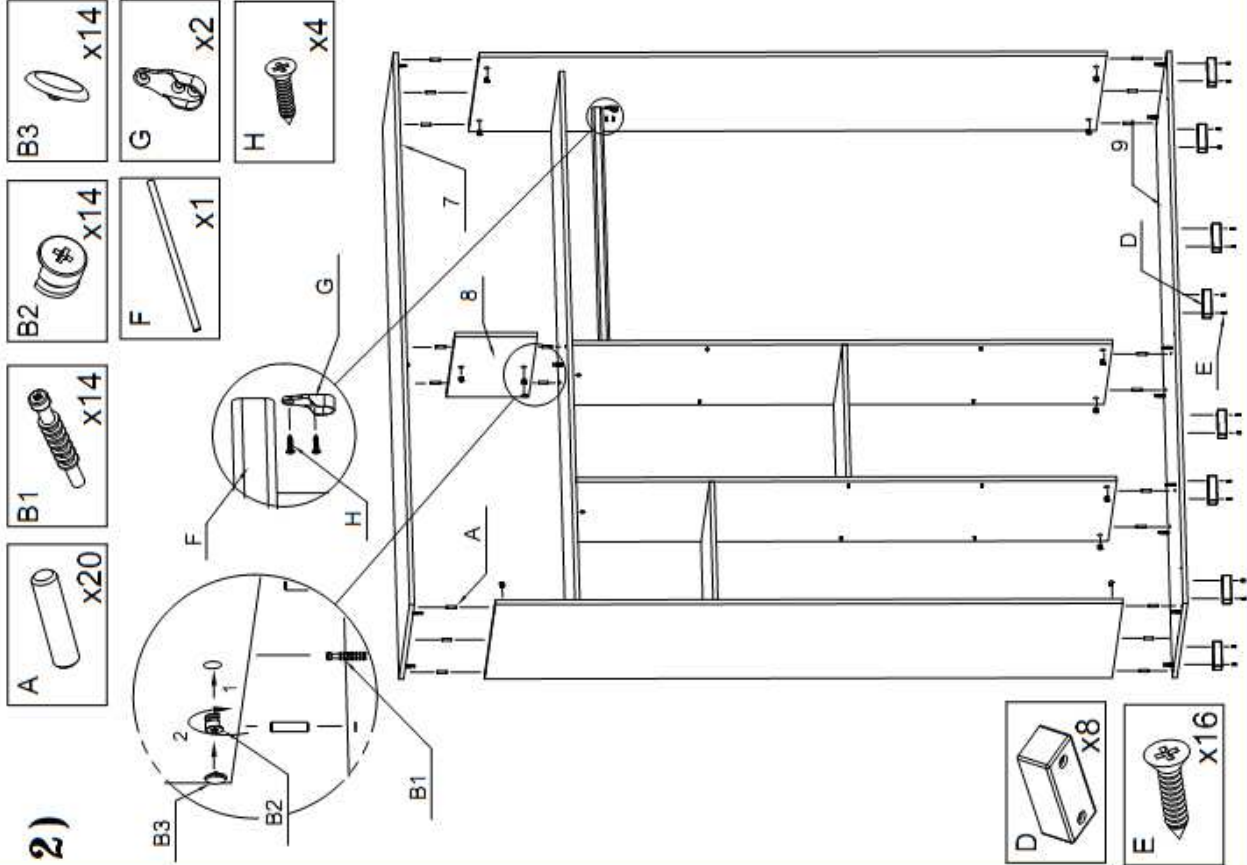

Instrukcja montażu

3)

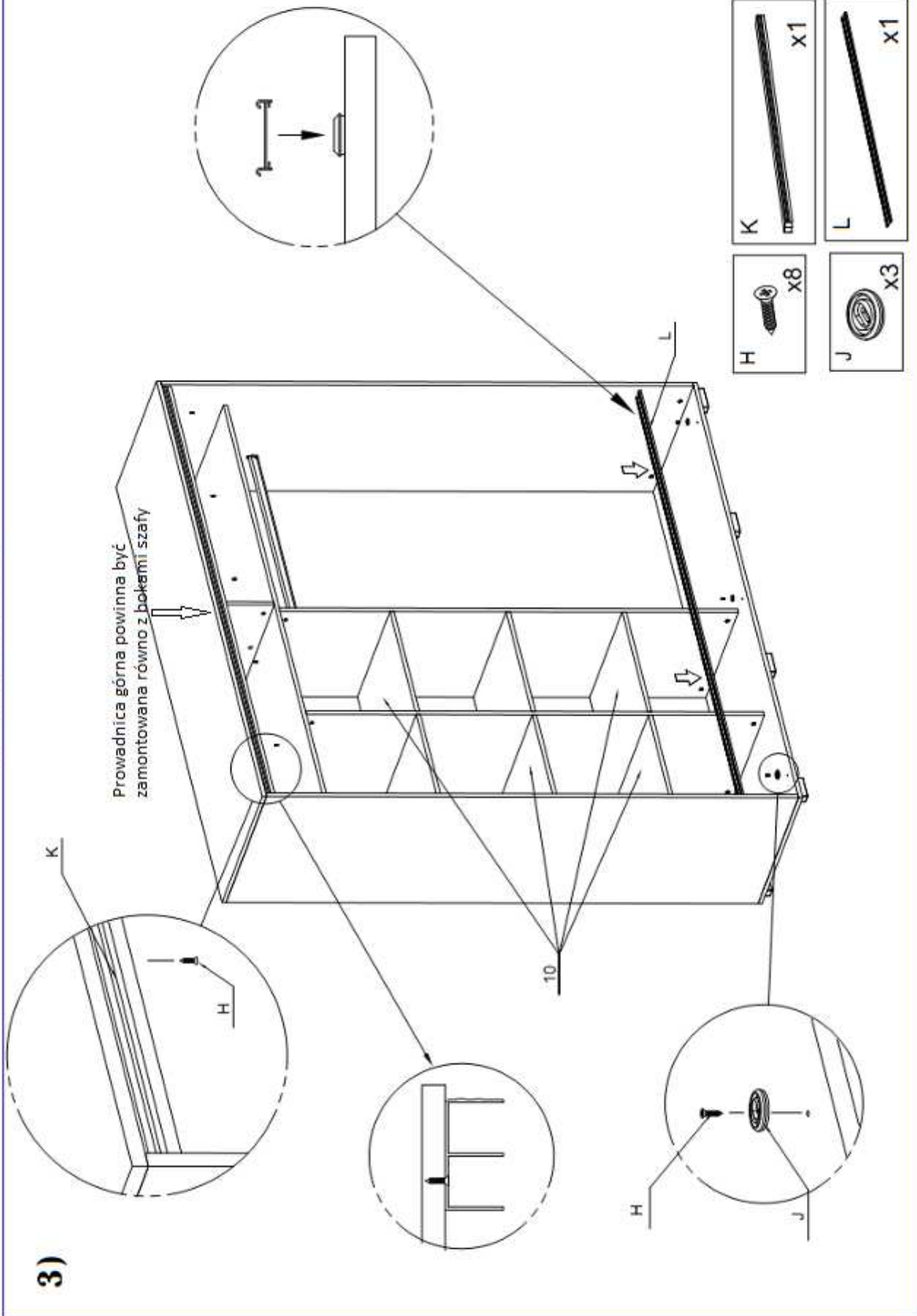

Prowadnica górna powinna być zamontowana równo z bokami szafy

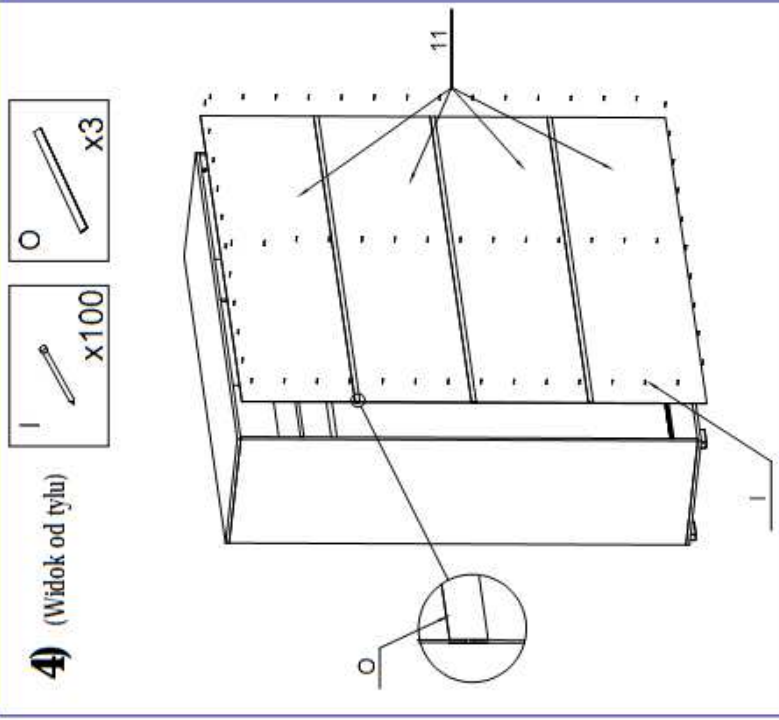

Instrukcja montażu



4) (Widok od tyłu)

-  x100
-  x3

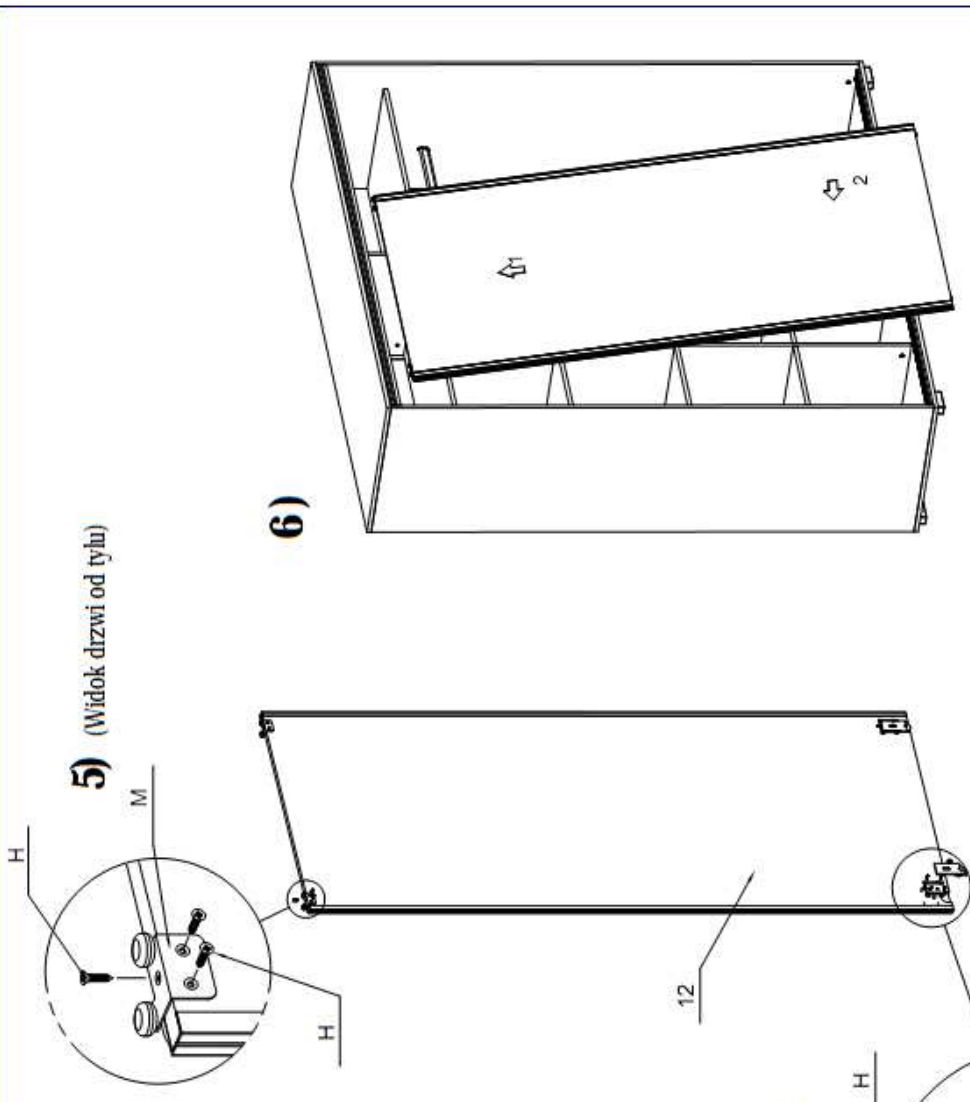



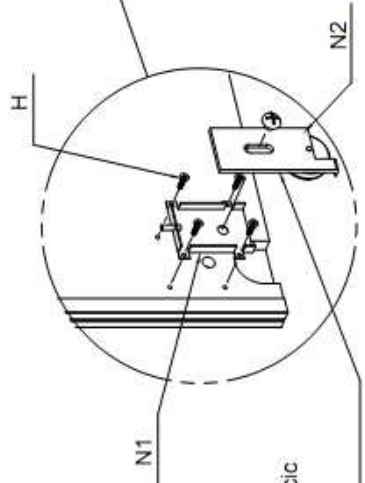
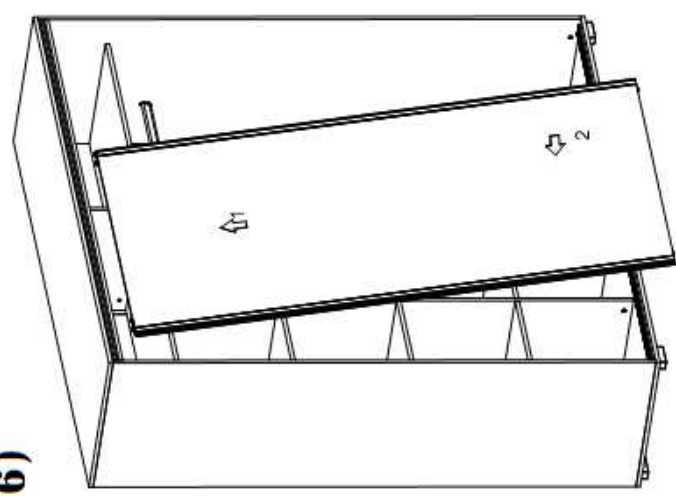

5) (Widok drzwi od tyłu)

6)



Rolke wózka dolnego dokreć po osadzeniu skrzydła drzwiowego w szafie

-  x4
-  x4
-  x4
-  x28