

# SIMPLE

## SWT91

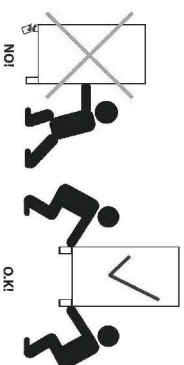
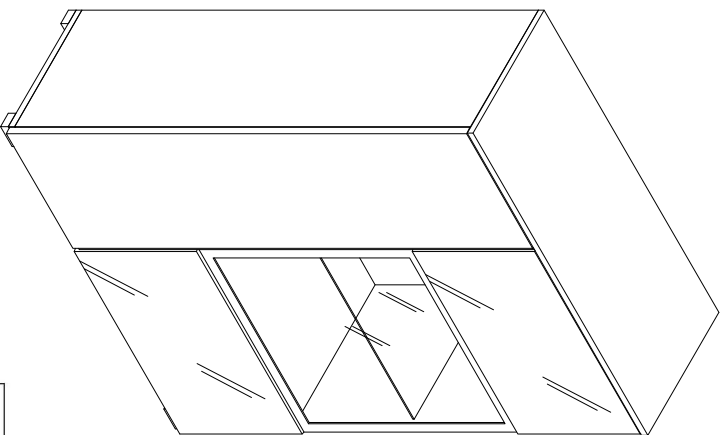

28.12.2017

- (D)** Montageanleitung
- (FR)** Notice de montage
- (NL)** Handleiding voor de montage
- (CZ)** Montážní návod
- (HU)** Szerelési útmutató
- (TR)** Montaj talimatı
- (GB)** Assembly Instructions
- (IT)** Istruzioni di montaggio
- (PL)** Instrukcja montażu
- (SK)** Návod na montáž
- (RO)** Instrucțiunile de montaj
- (RU)** Инструкции по монтажу

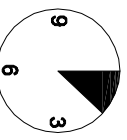
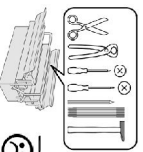

20 min.

1

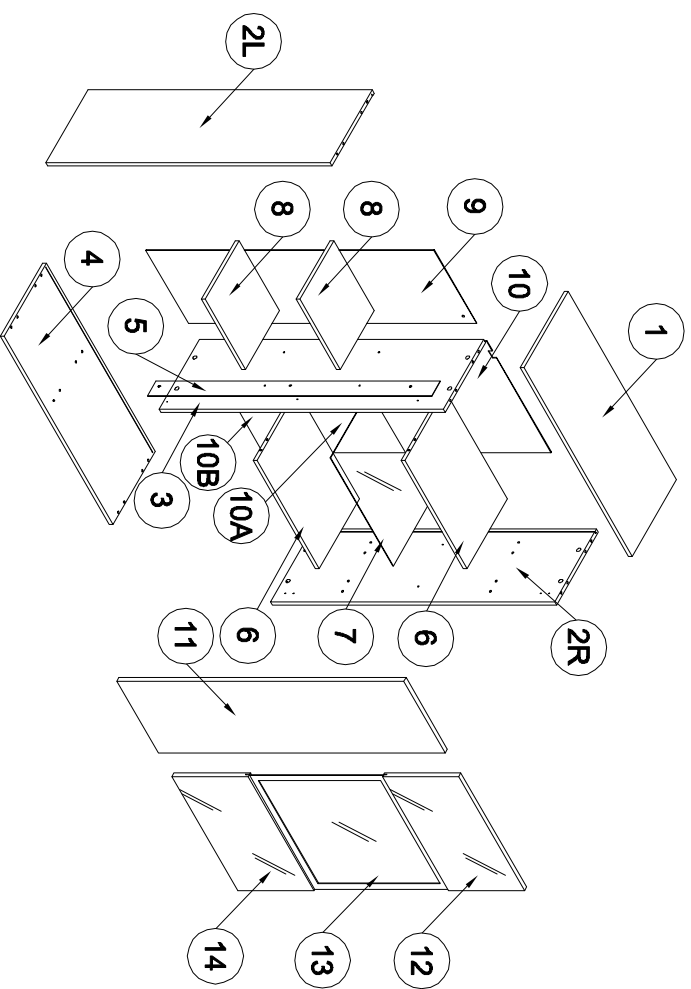

<b>C</b> x20	<b>Z</b> x18	<b>NK</b> x2	<b>ZA</b> WENGE x1	<b>ZE</b> x4	<b>TB</b> x1	<b>TA</b> x1	<b>Z</b> x8
<b>KK</b> x2	<b>B</b> x20	<b>N</b> 3x20 x2	<b>X</b> x1	<b>Y</b> x4	<b>ZC</b> x1	<b>NC</b> 4x16 x1	<b>ZD</b> x8
<b>A</b> 8x32 x20	<b>RC</b> x4	<b>X</b> x12	<b>RC</b> x4	<b>H</b> 6,3x13 x8	<b>PBS</b> x4	<b>ND</b> 3,5x16 x9	<b>GLUE</b> x3
<b>GLUE</b> x3							

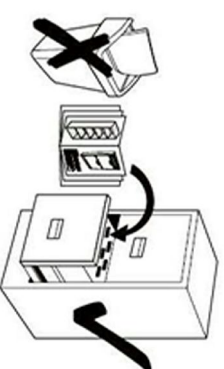
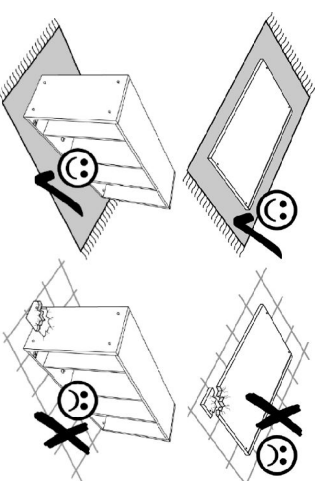

2

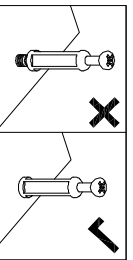

3

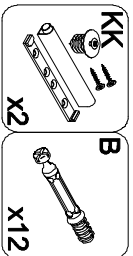
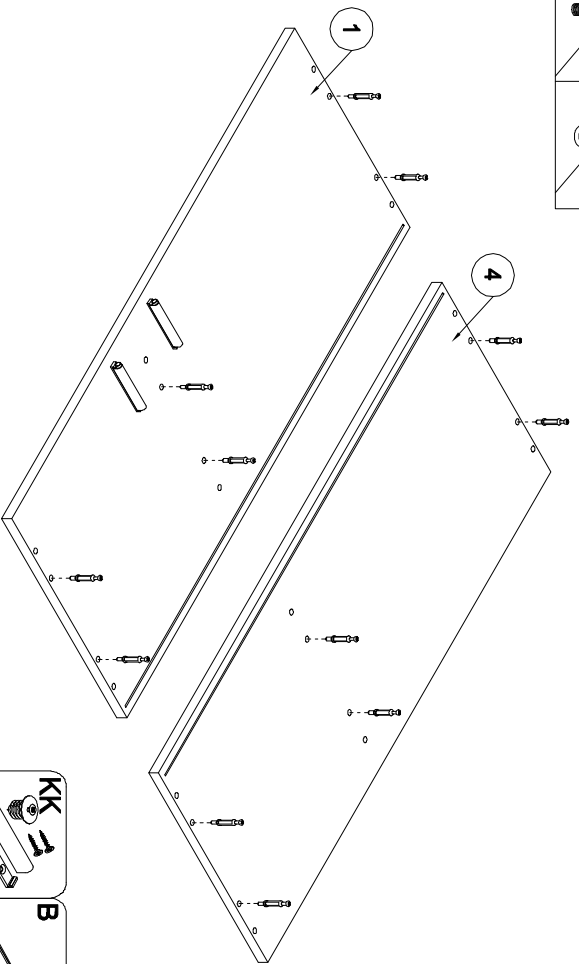

4

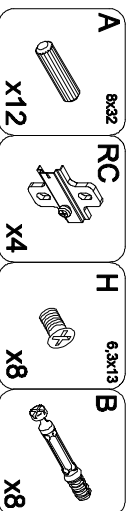
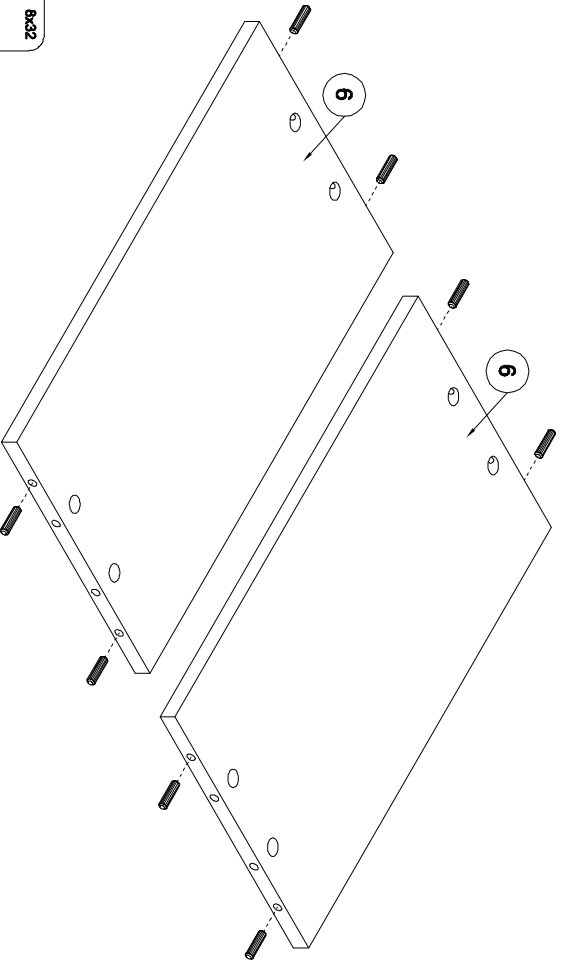
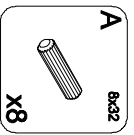



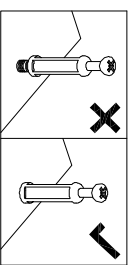
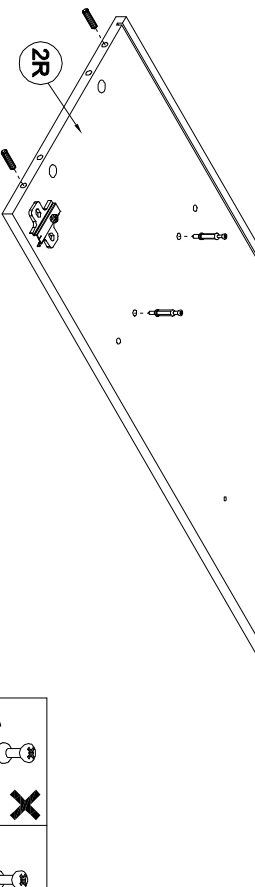
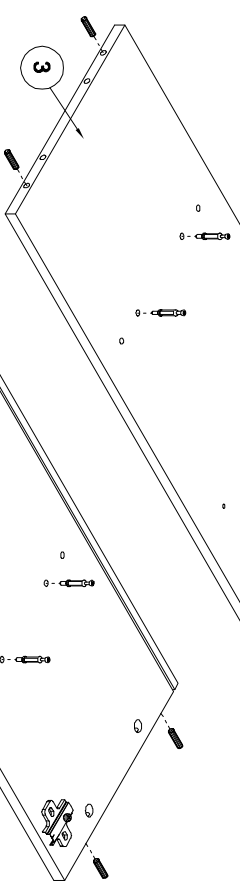
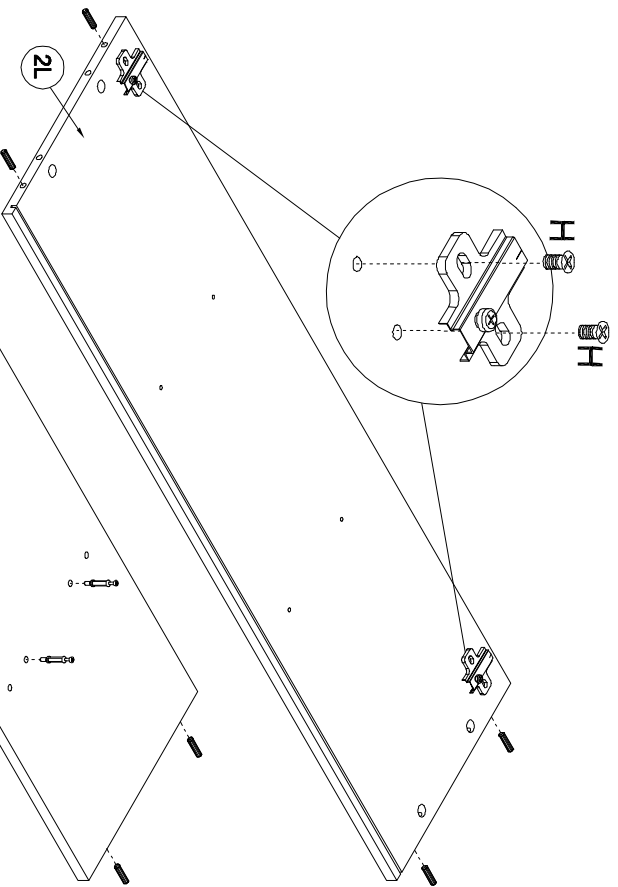

5

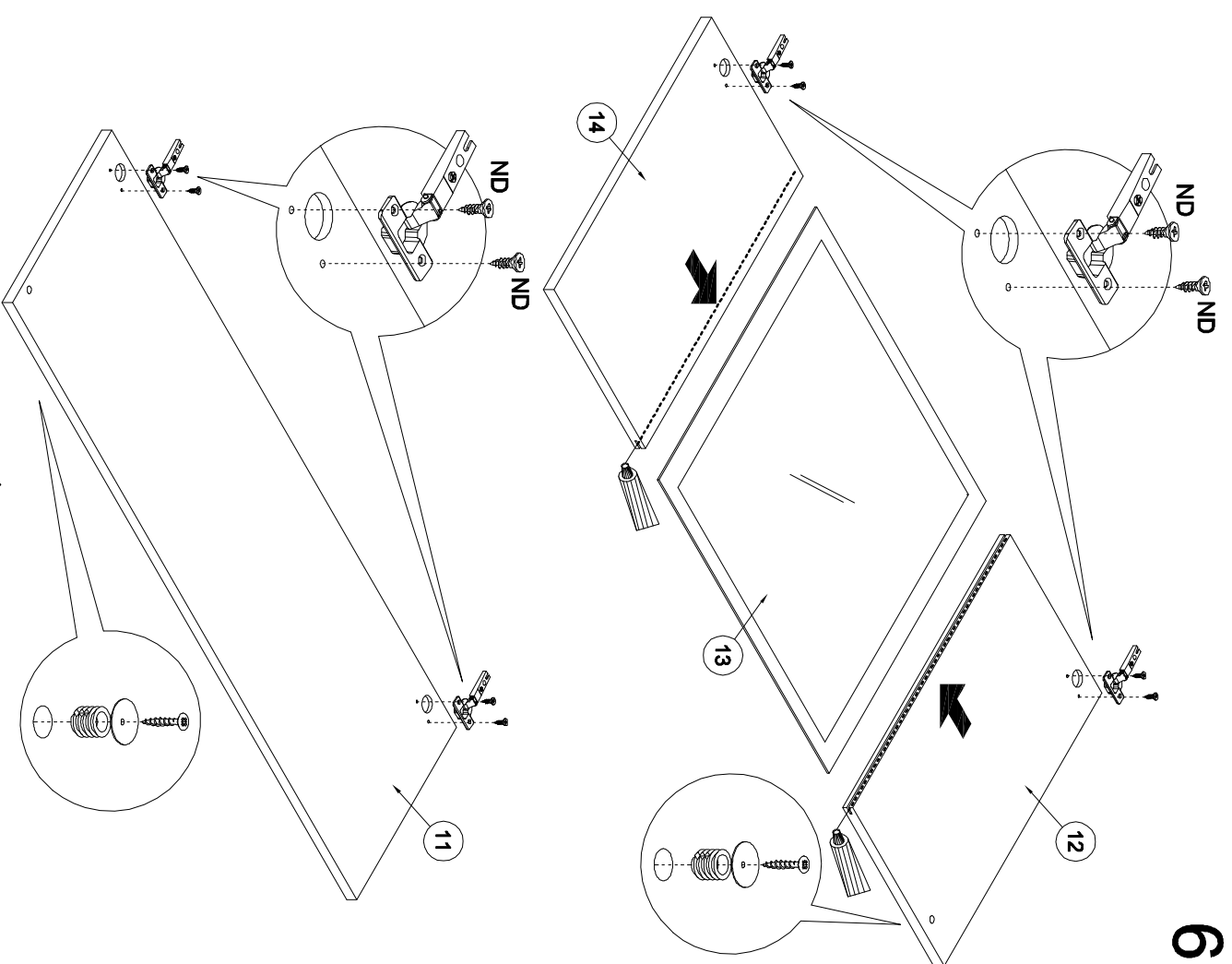



6

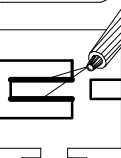
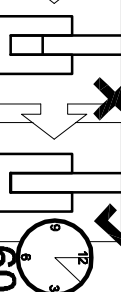

-  PBS X4
  -  ND 3.5x16 X8
  -  KK X2
  -  GLUE X1
- 
- 
- 60 min

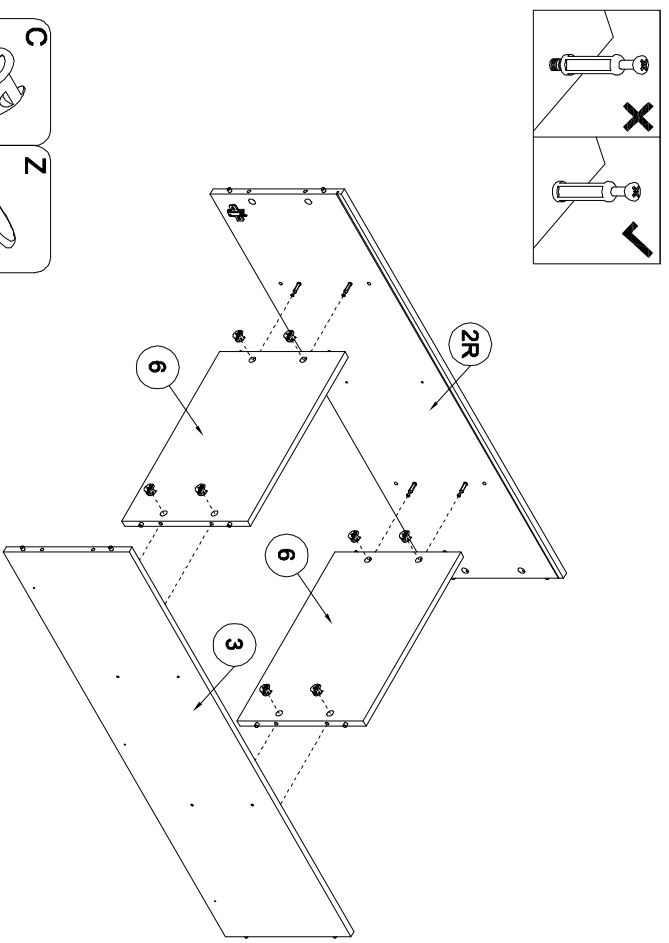
7



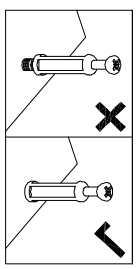

-  C X8
-  Z X8

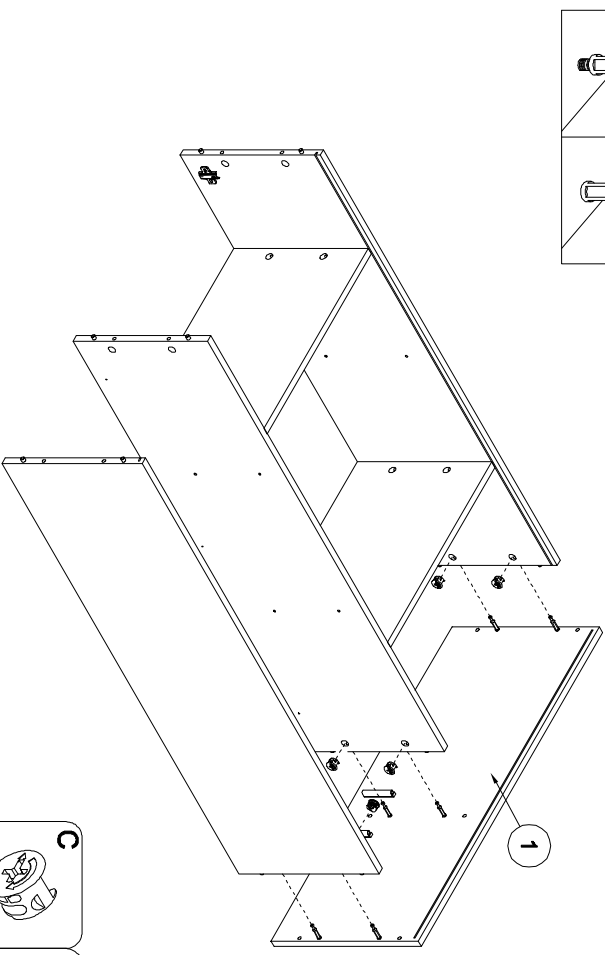

8



-  C X6
-  Z X5



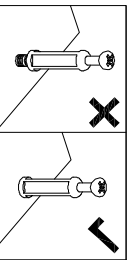

9

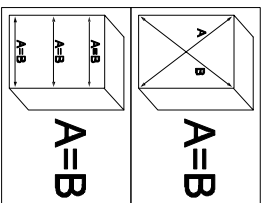
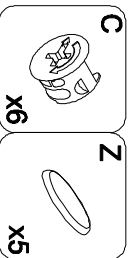
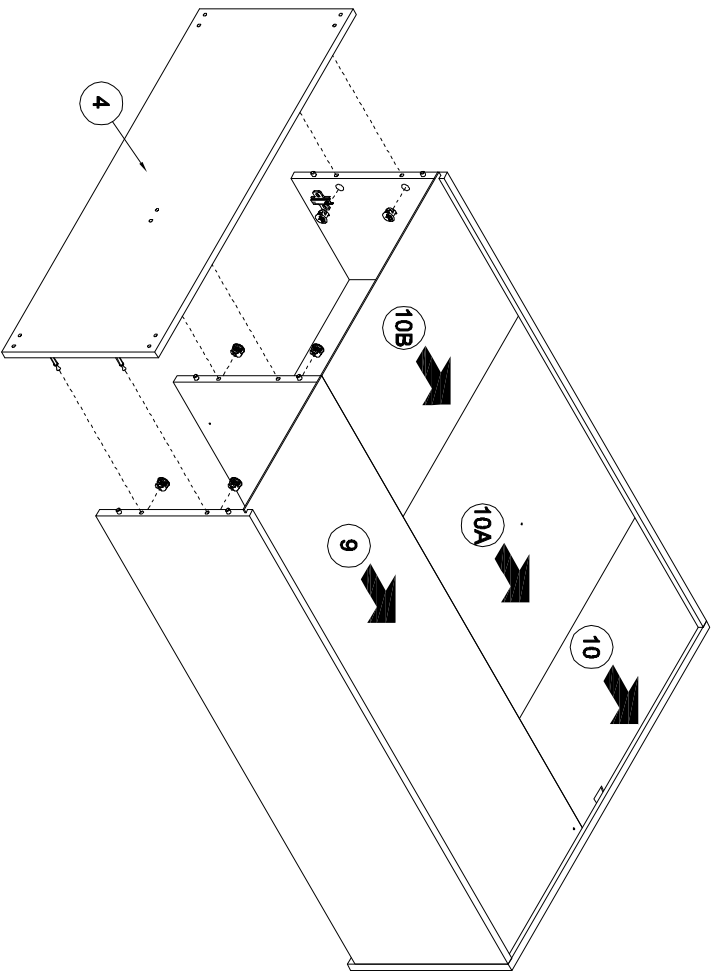

10

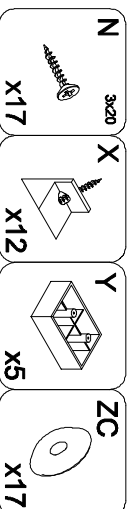
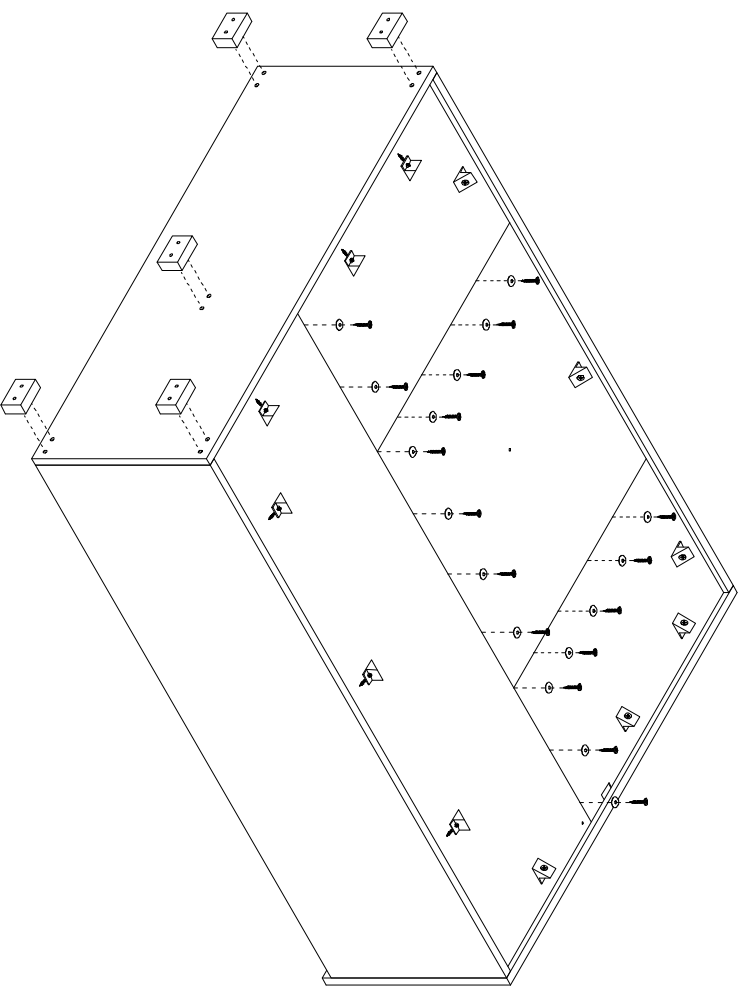

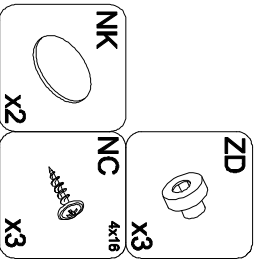
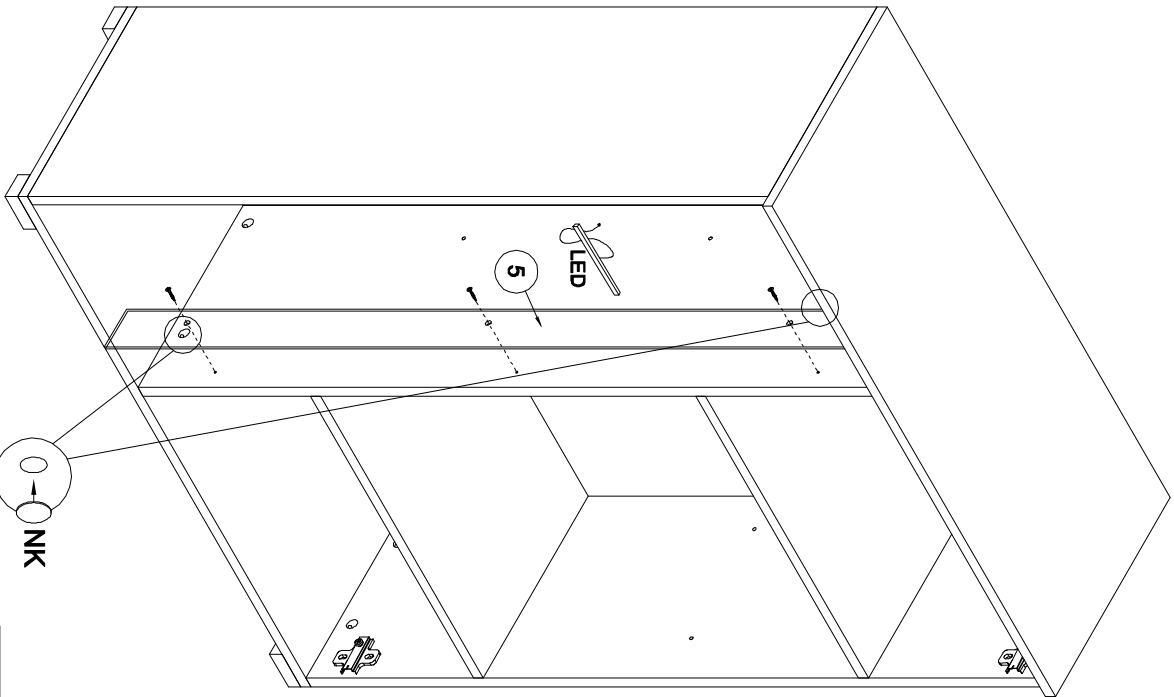
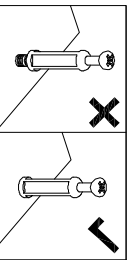

11

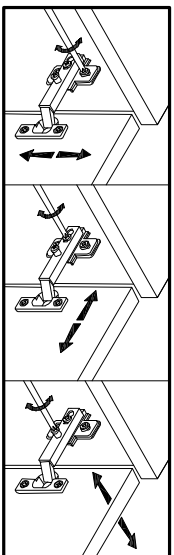
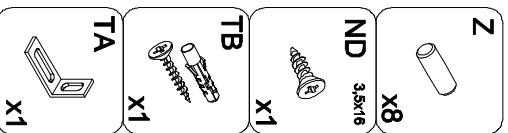
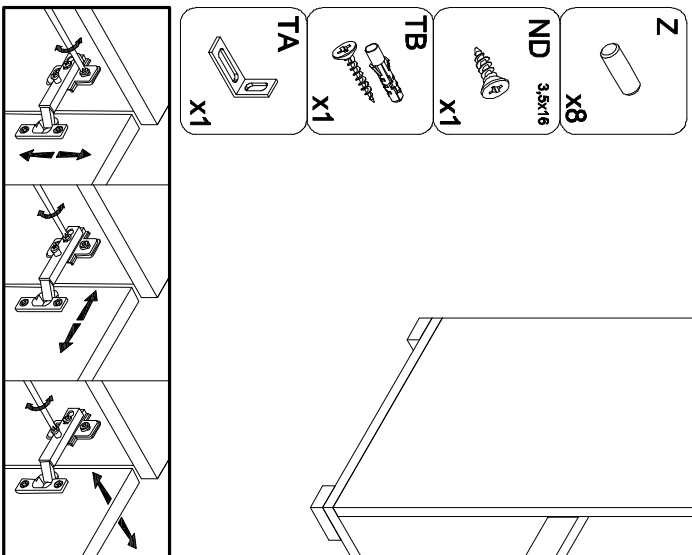
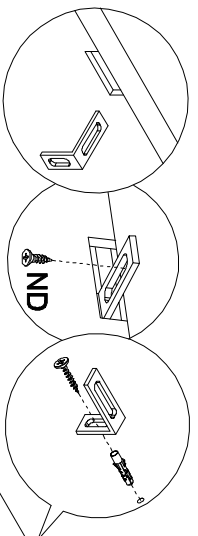

12

