

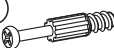







- B1**   $\phi$  8x28 x12
- T1**  x12
- M1**  x12
- C2**   $\phi$  20 x12
- F1**  x3
- P2**  3x16 x21

- Y0**  x4  
KR0
- S8**  4x13 x8

- F37**  x5
- S9**  4x16 x10

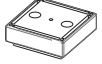
Nr	Ausmaß		St
1	378	379	15 1
2	378	379	15 1
3	378	379	15 1
4	790	379	15 1
5	790	400	15 1
6	388	391	18 1
7	388	391	18 1
8	405	391	2 2

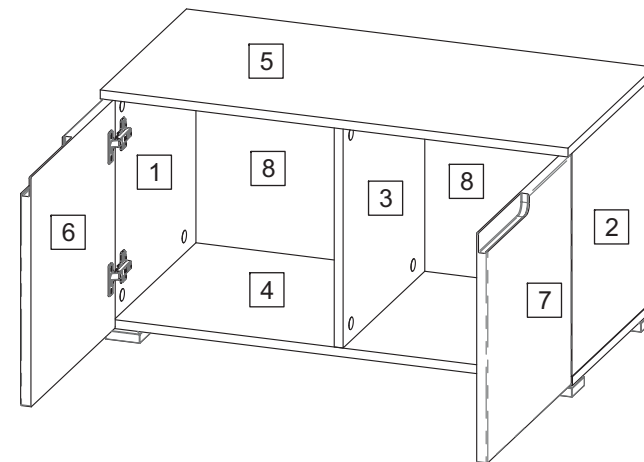

0 10 20 30 40 50 60 70 80 90 100 110 120 130 140 150 160 170 180 190 200



# 1

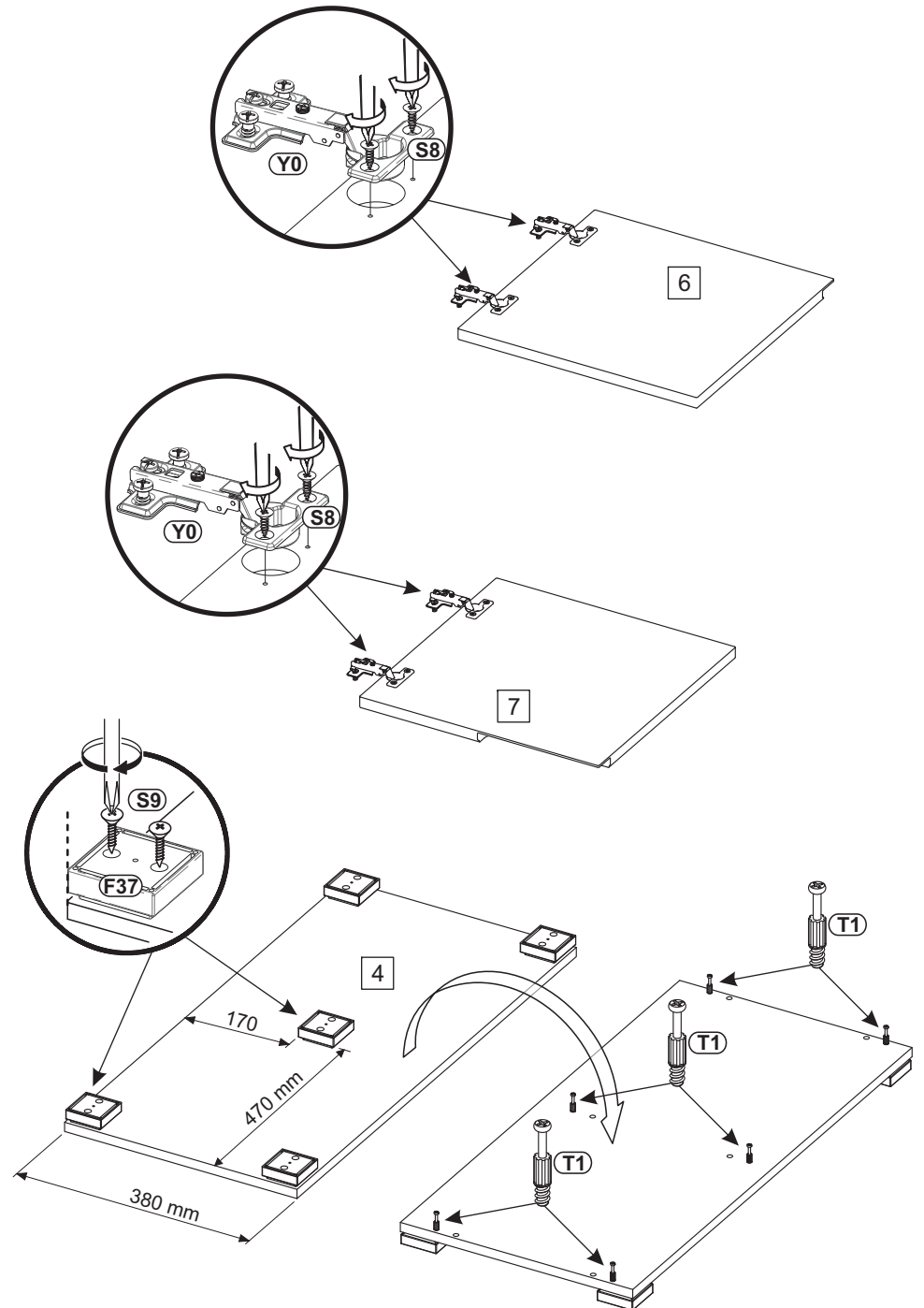
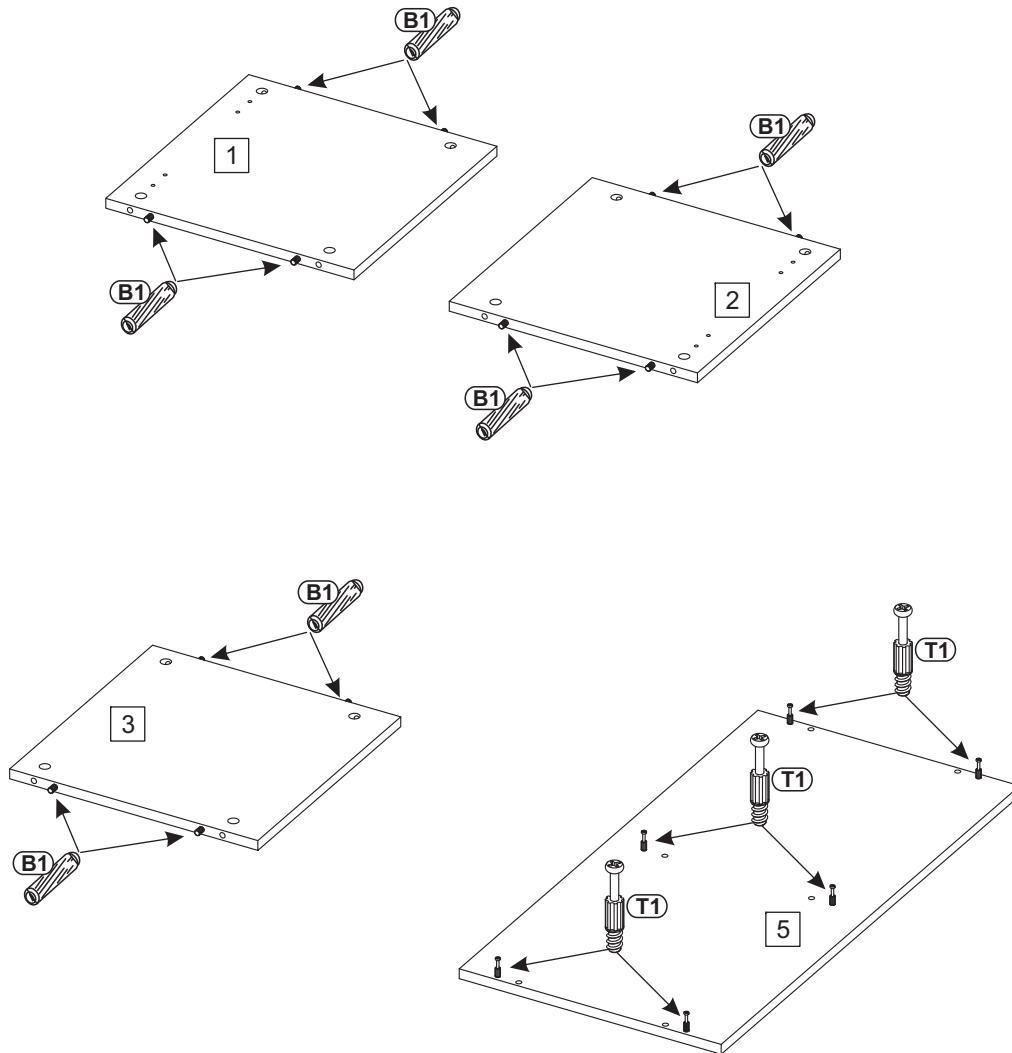
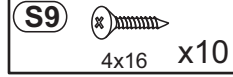
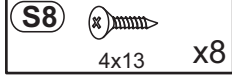
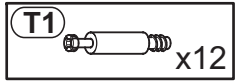
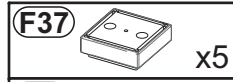
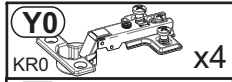
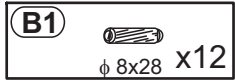

## 2

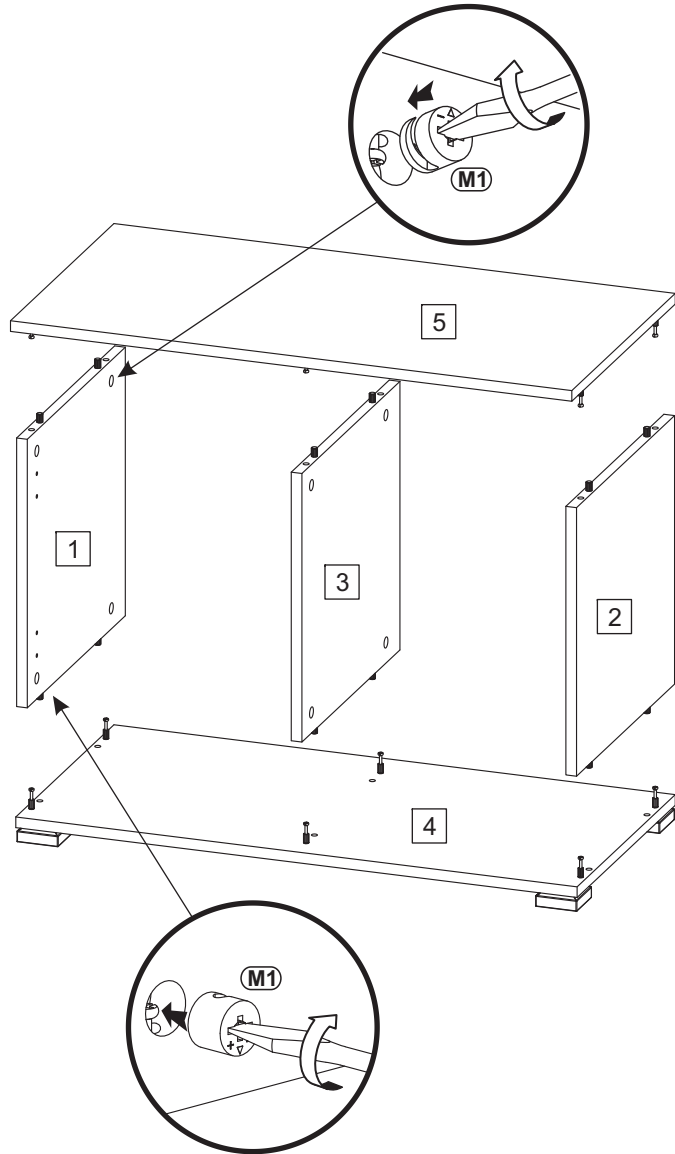

## 3

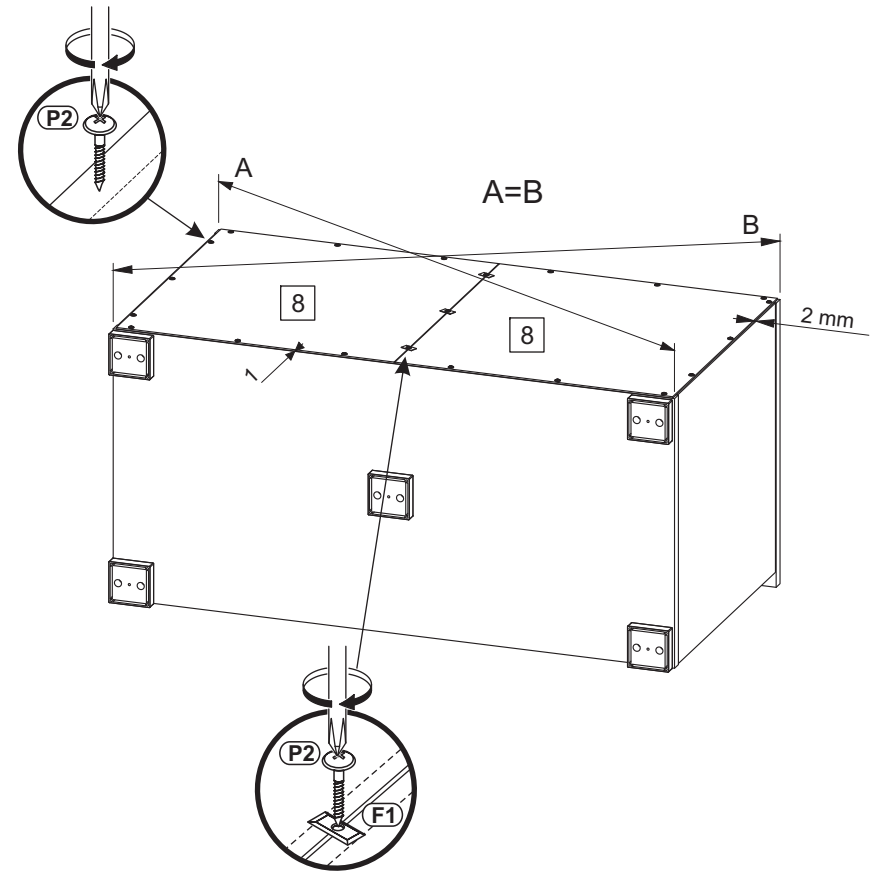
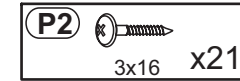
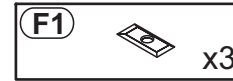

# 4

**C2**  
φ 20 x12

