

CARMEN

R-7

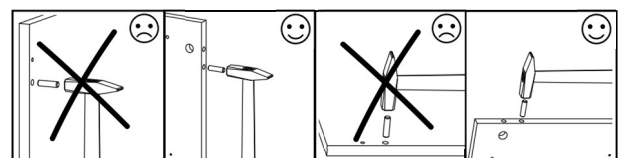

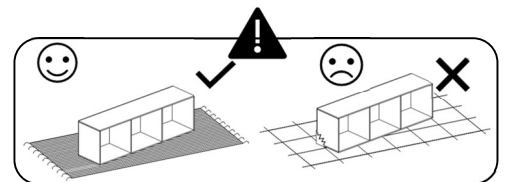
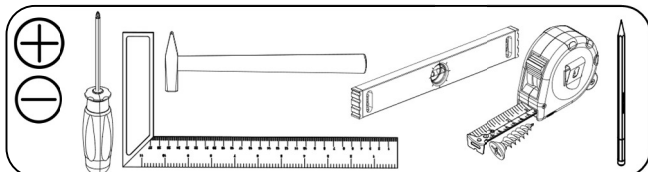
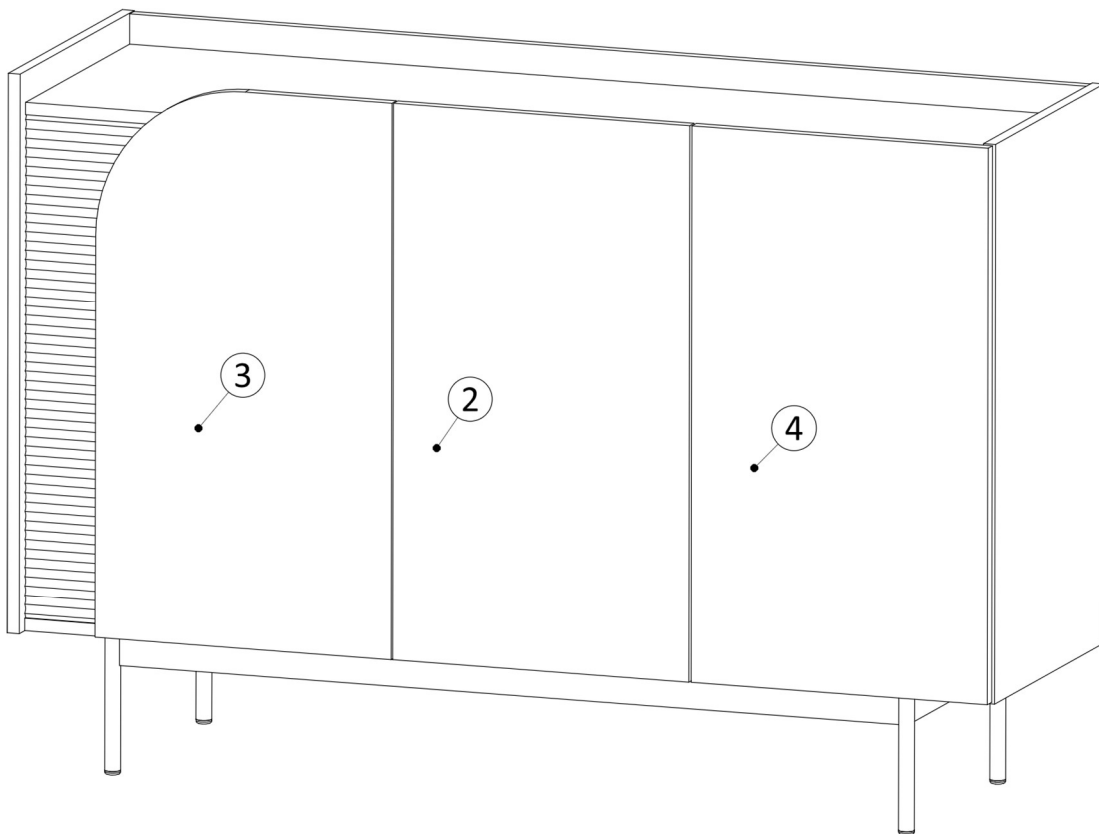
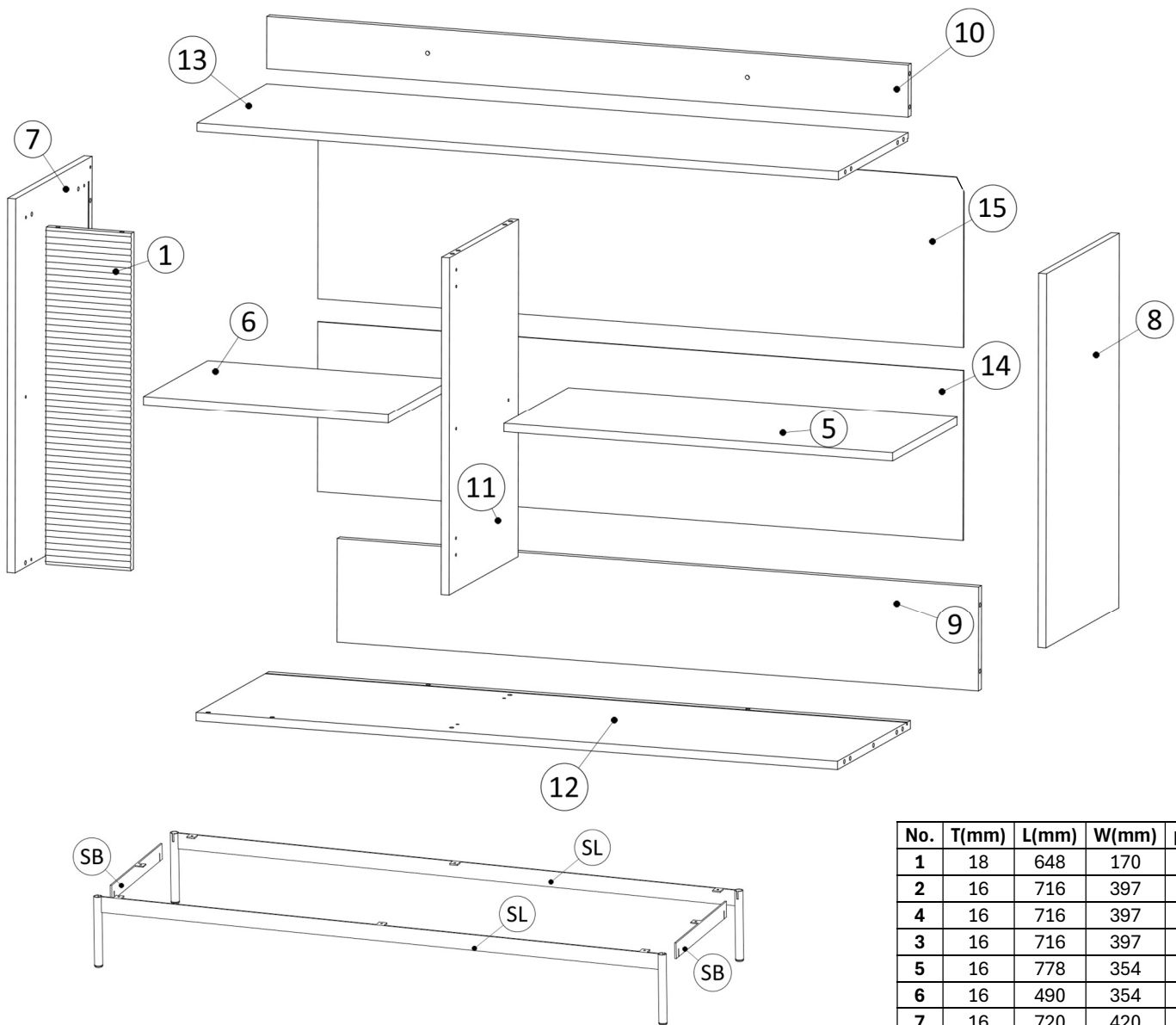

No.	T(mm)	L(mm)	W(mm)	pcs.
1	18	648	170	1
2	16	716	397	1
4	16	716	397	1
3	16	716	397	1
5	16	778	354	1
6	16	490	354	1
7	16	720	420	1
8	16	720	400	1
9	16	1284	200	1
10	16	1284	100	1
11	16	648	379	1
12	16	1284	400	1
13	16	1284	383	1
14	3	1292	327	1
15	3	1292	327	1

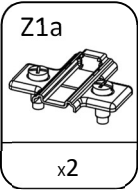
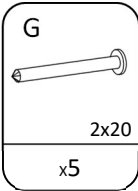
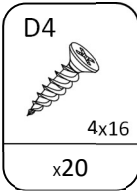
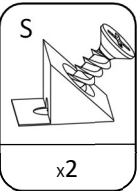
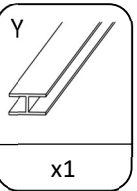
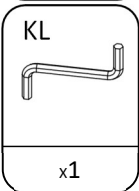
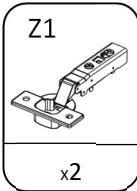
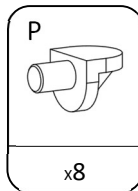
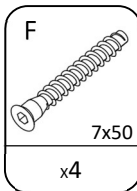
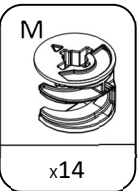
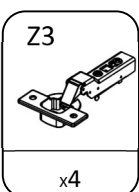
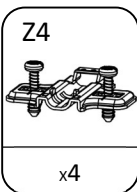
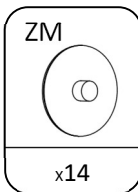
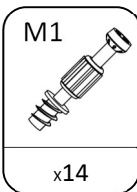
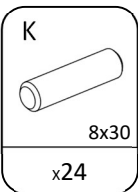
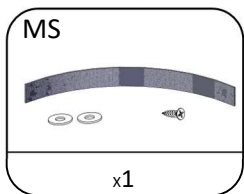

1

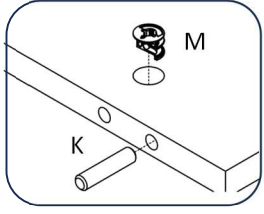
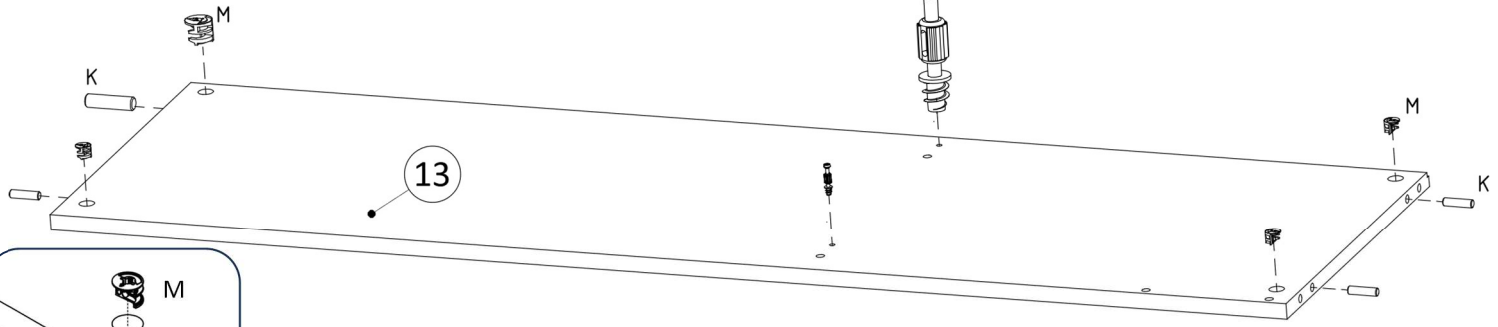
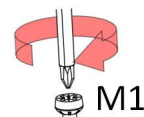
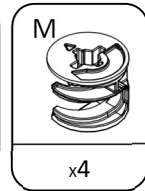
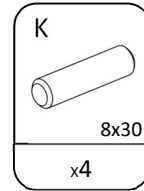
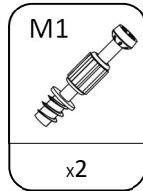
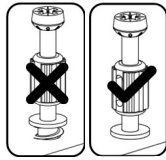

2

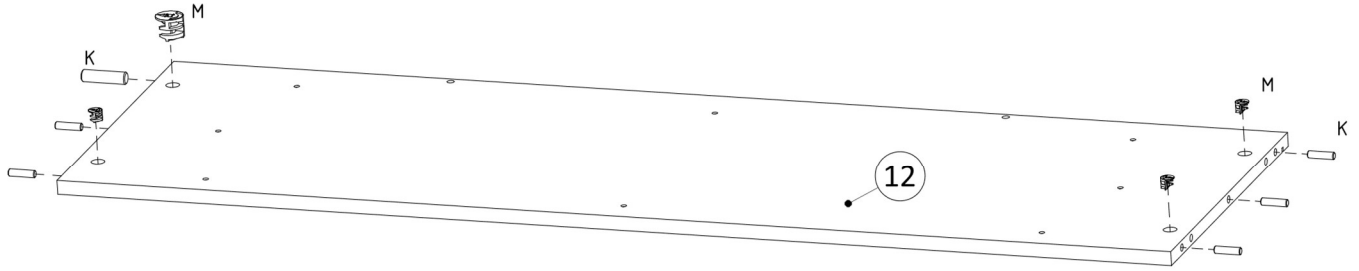
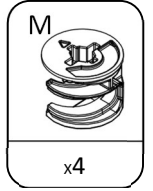
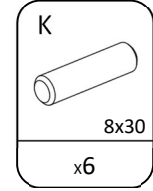
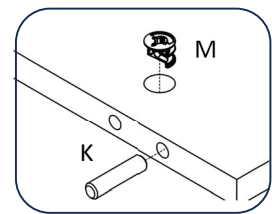

3

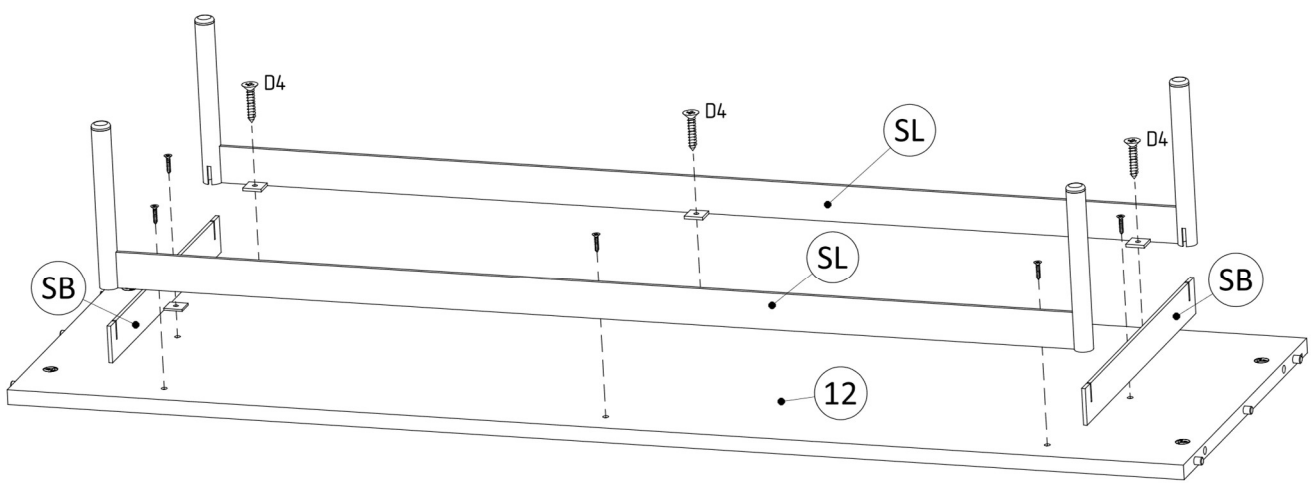
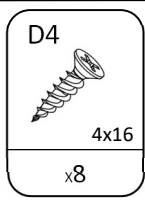

4

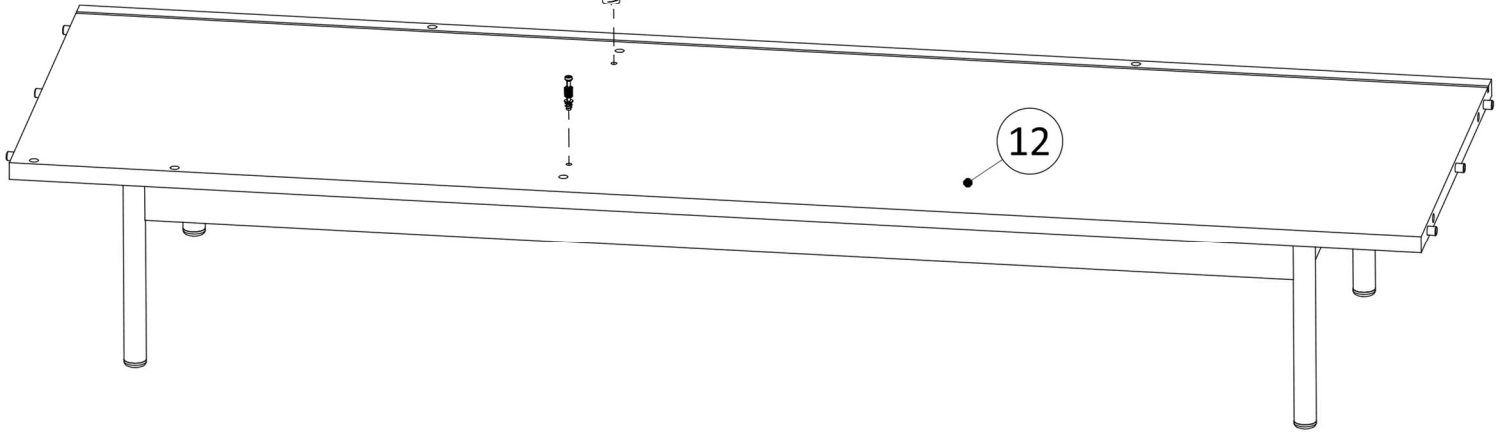
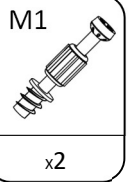
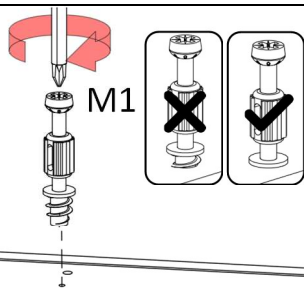

5

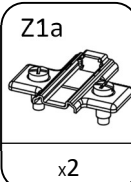
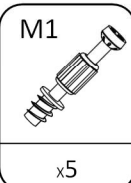
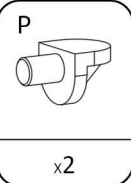
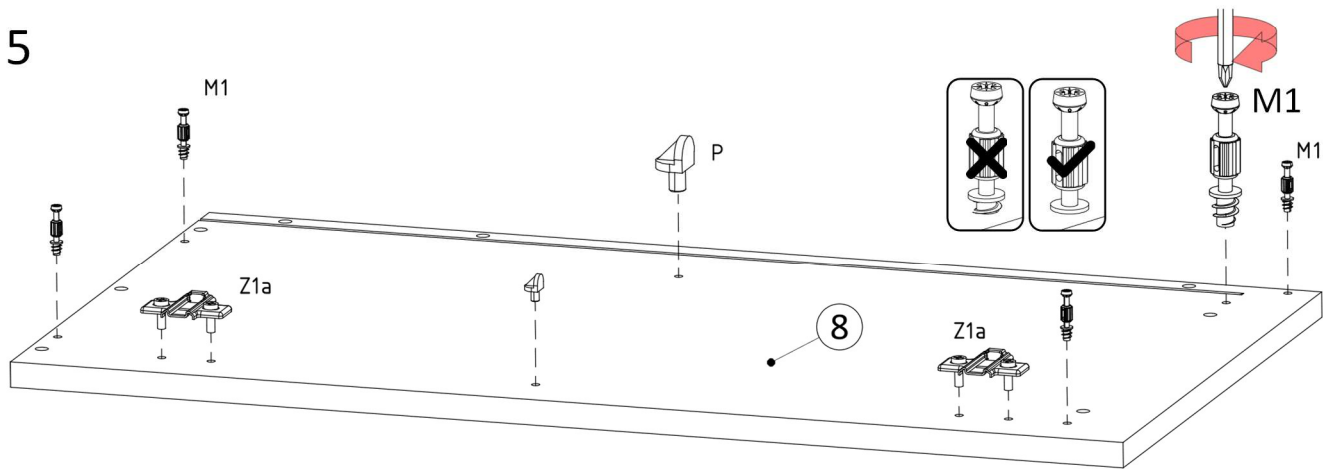

6

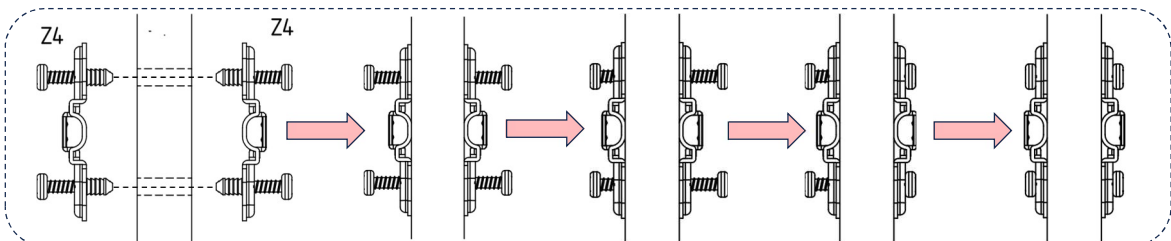
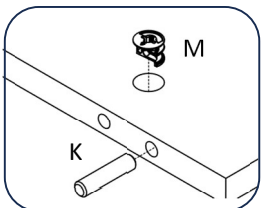
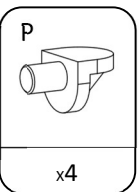
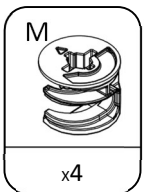
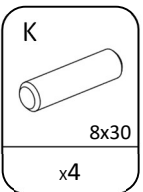
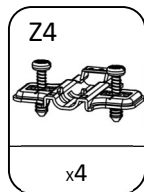
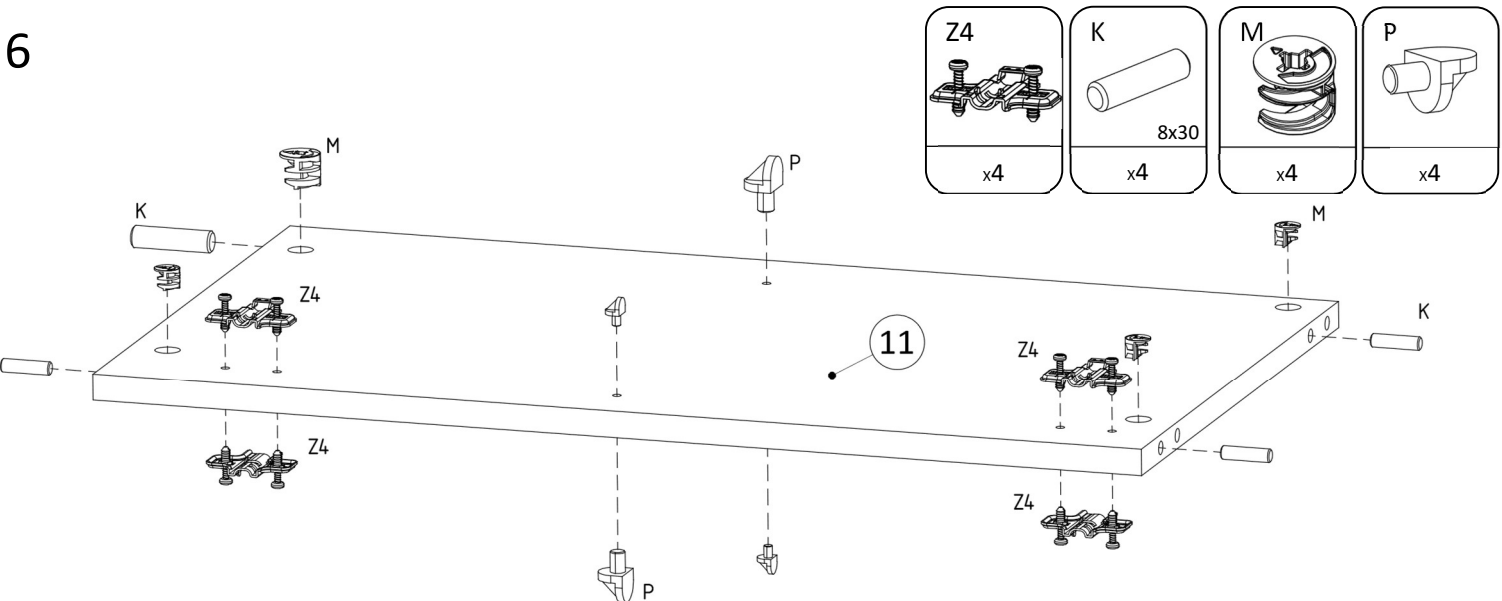

7

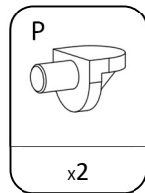
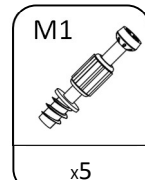
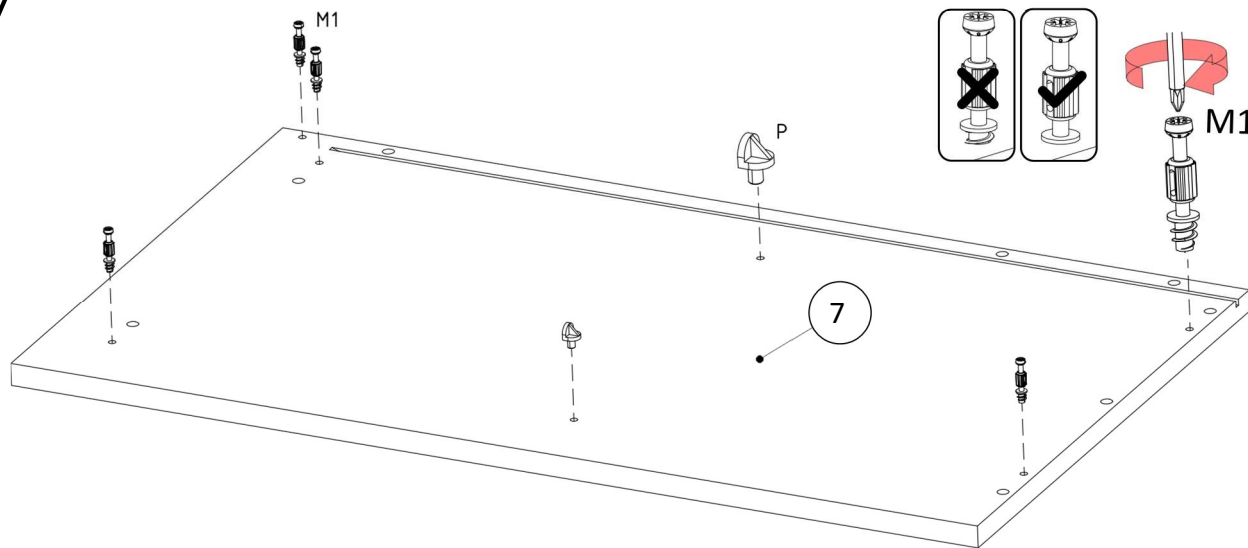

8

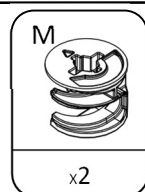
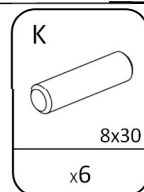
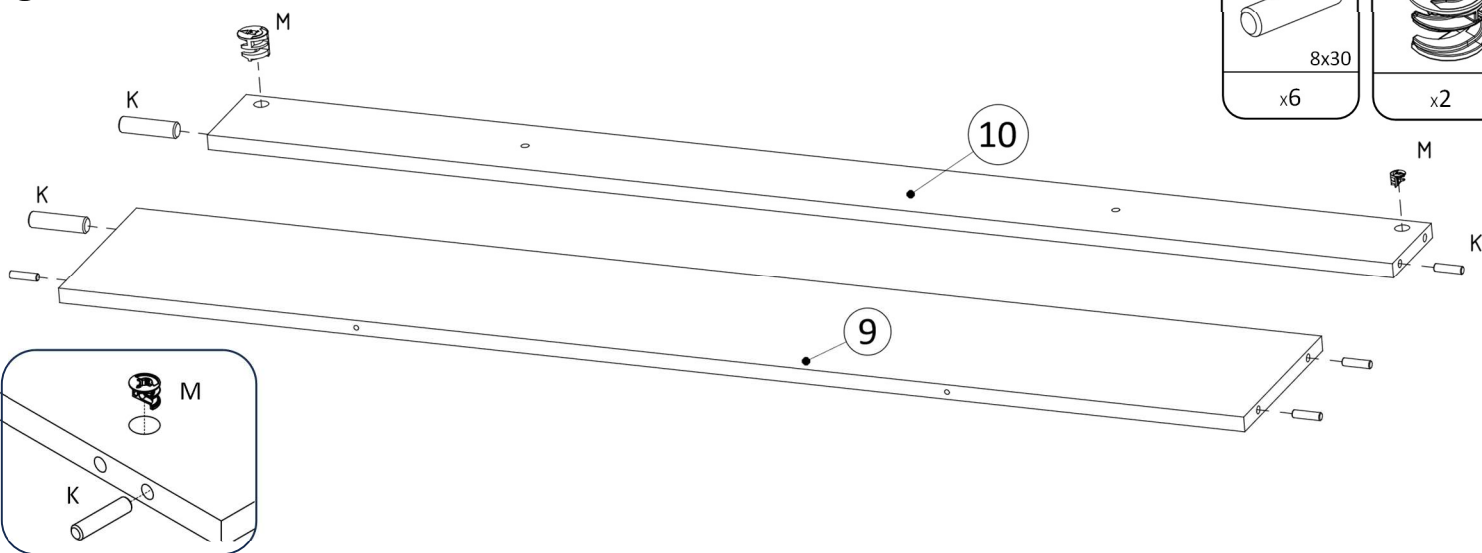

9

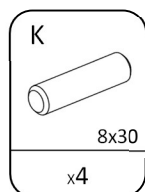
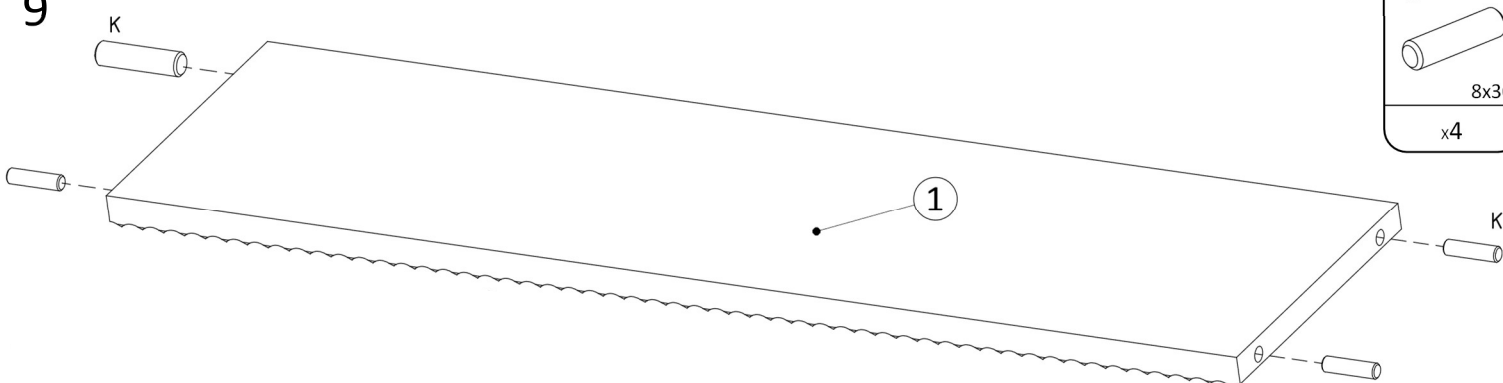

10

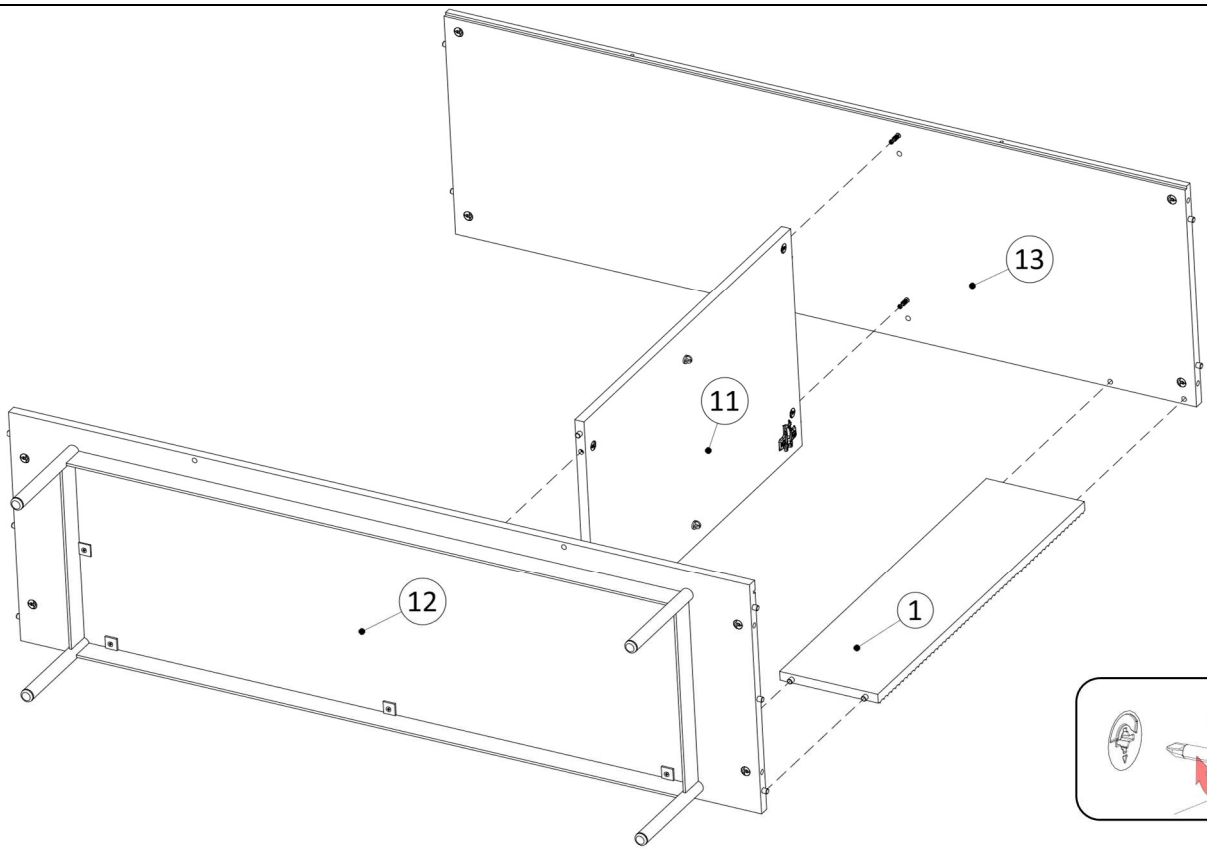

11

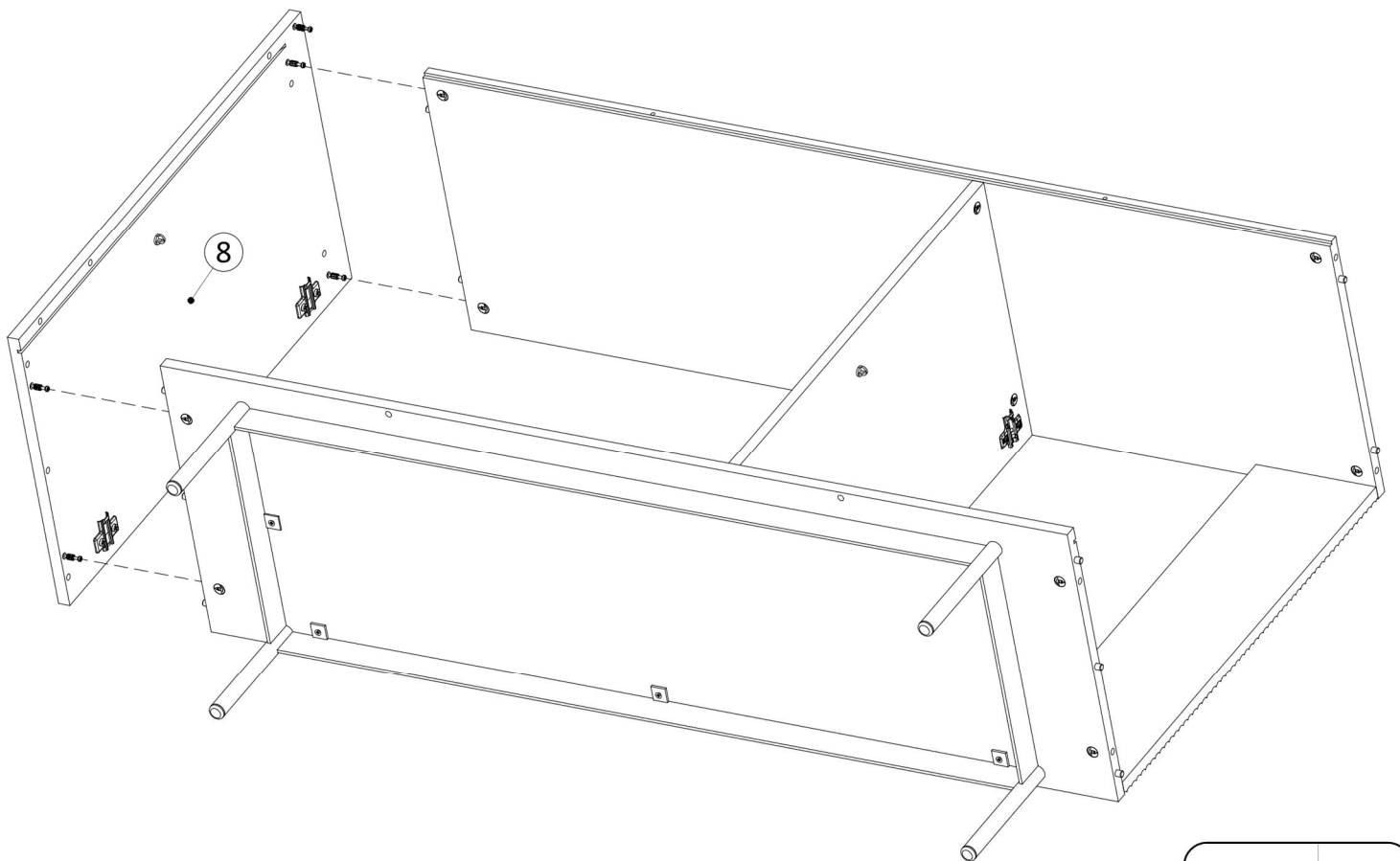

12

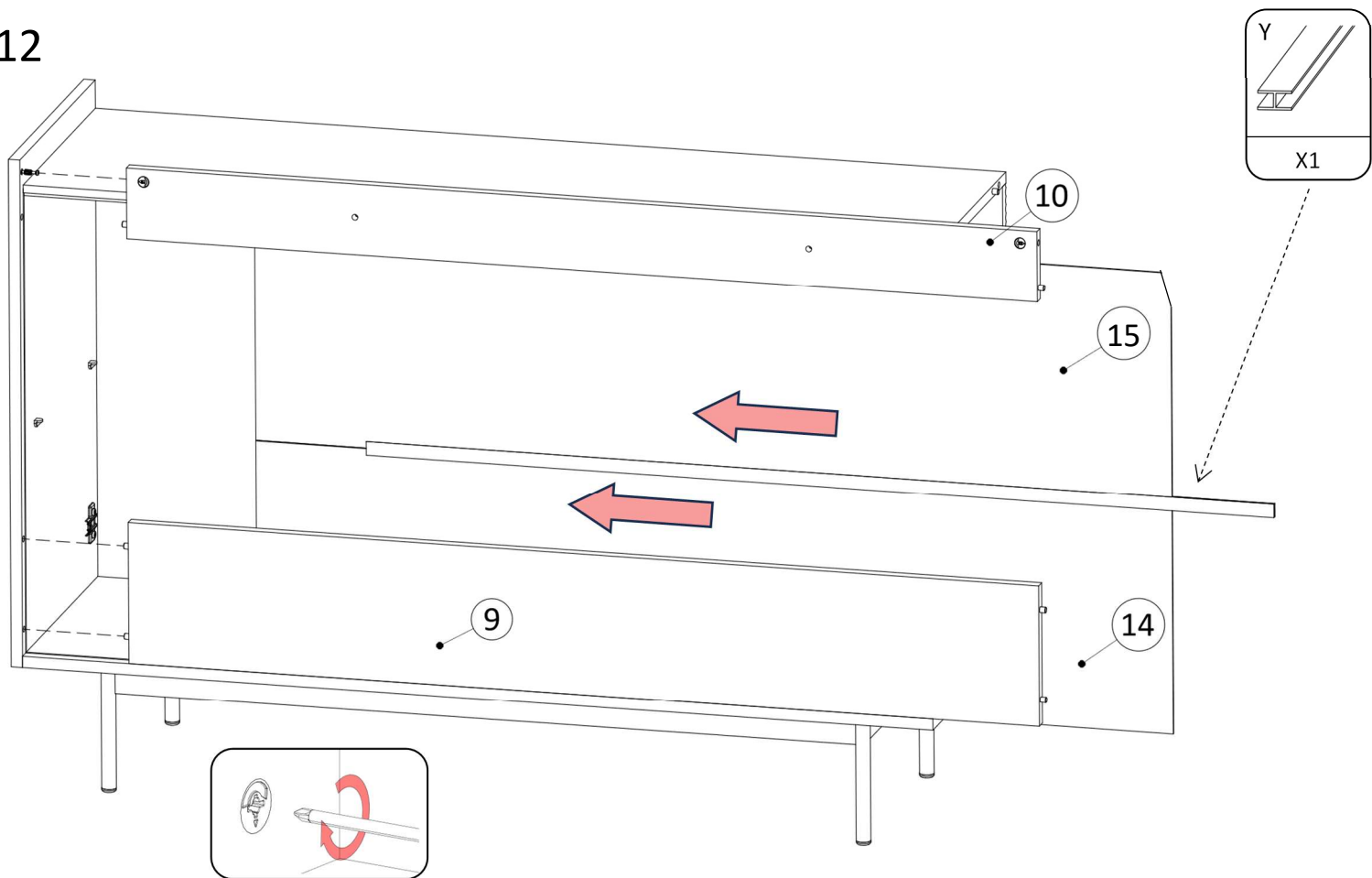

13

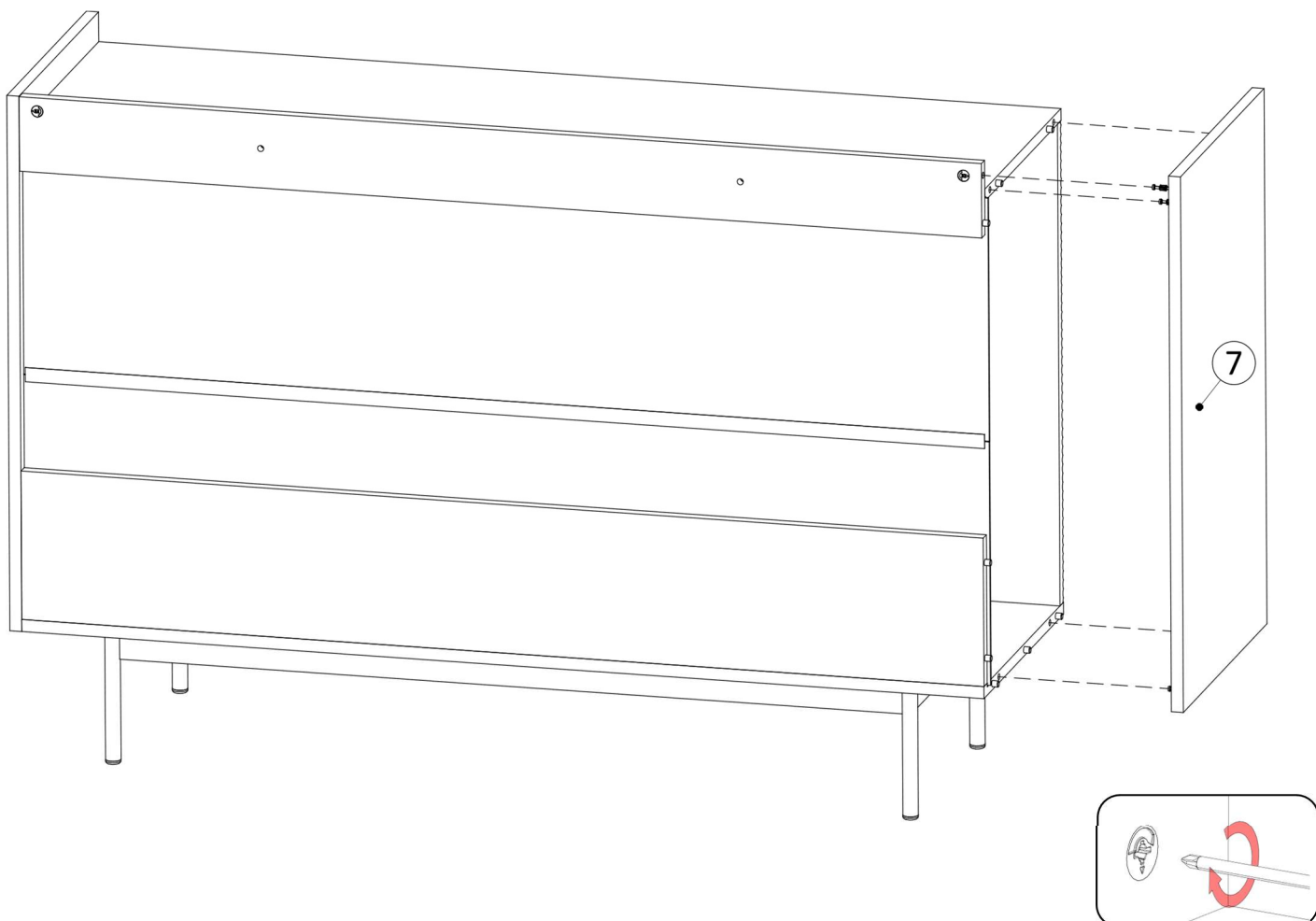

14

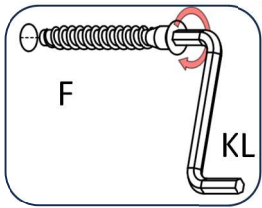
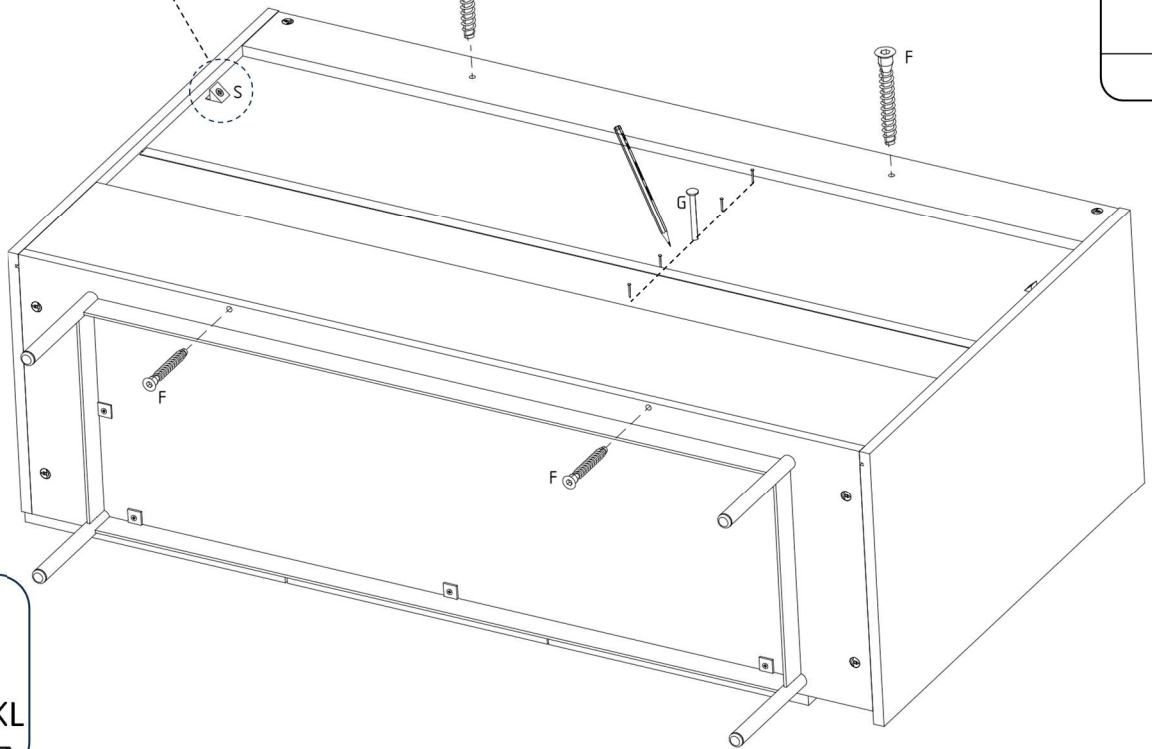
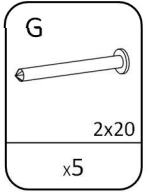
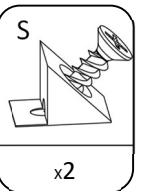
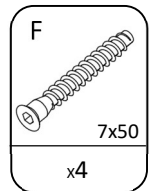
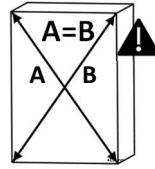
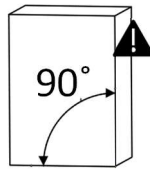
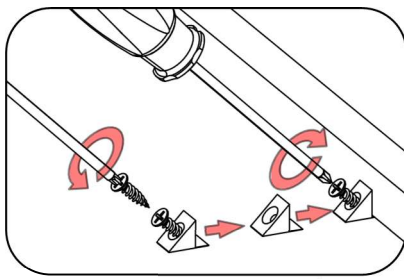

15

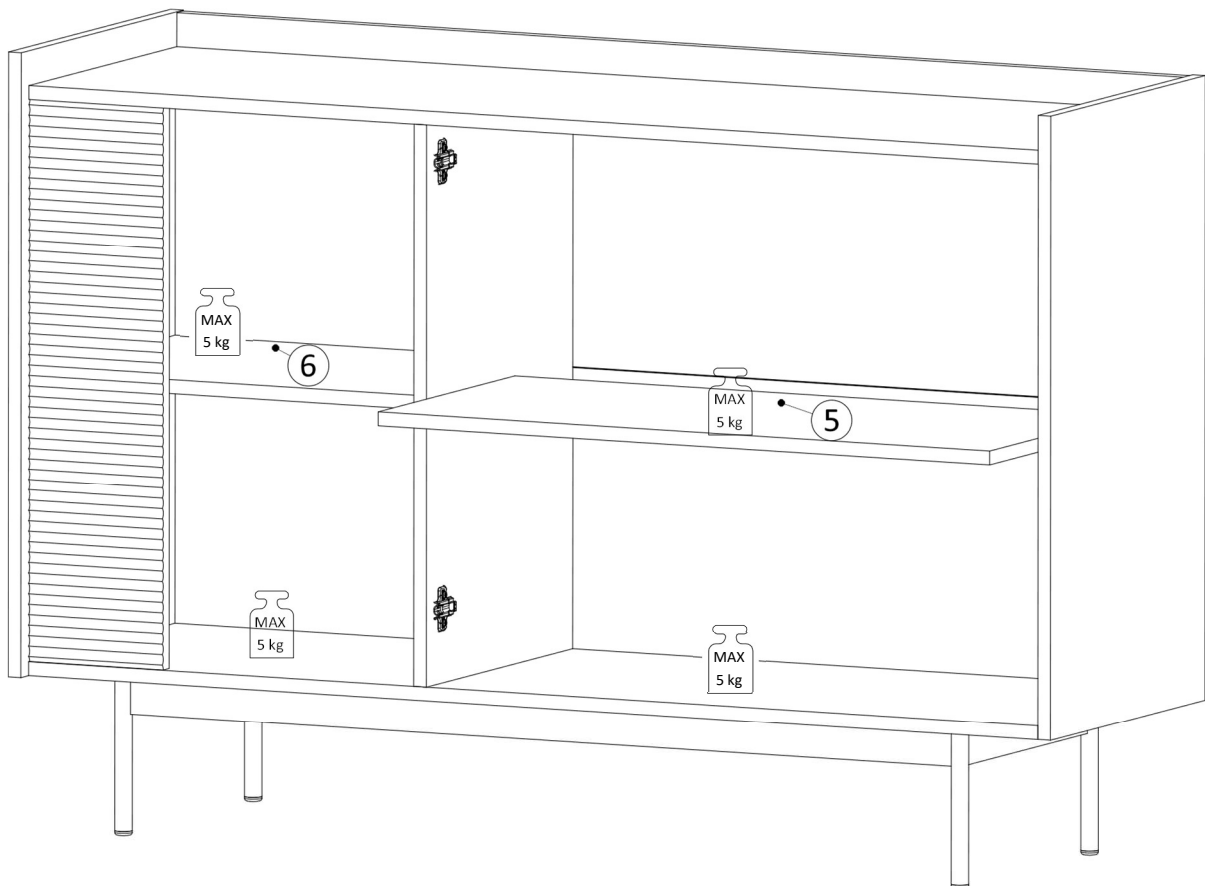

16

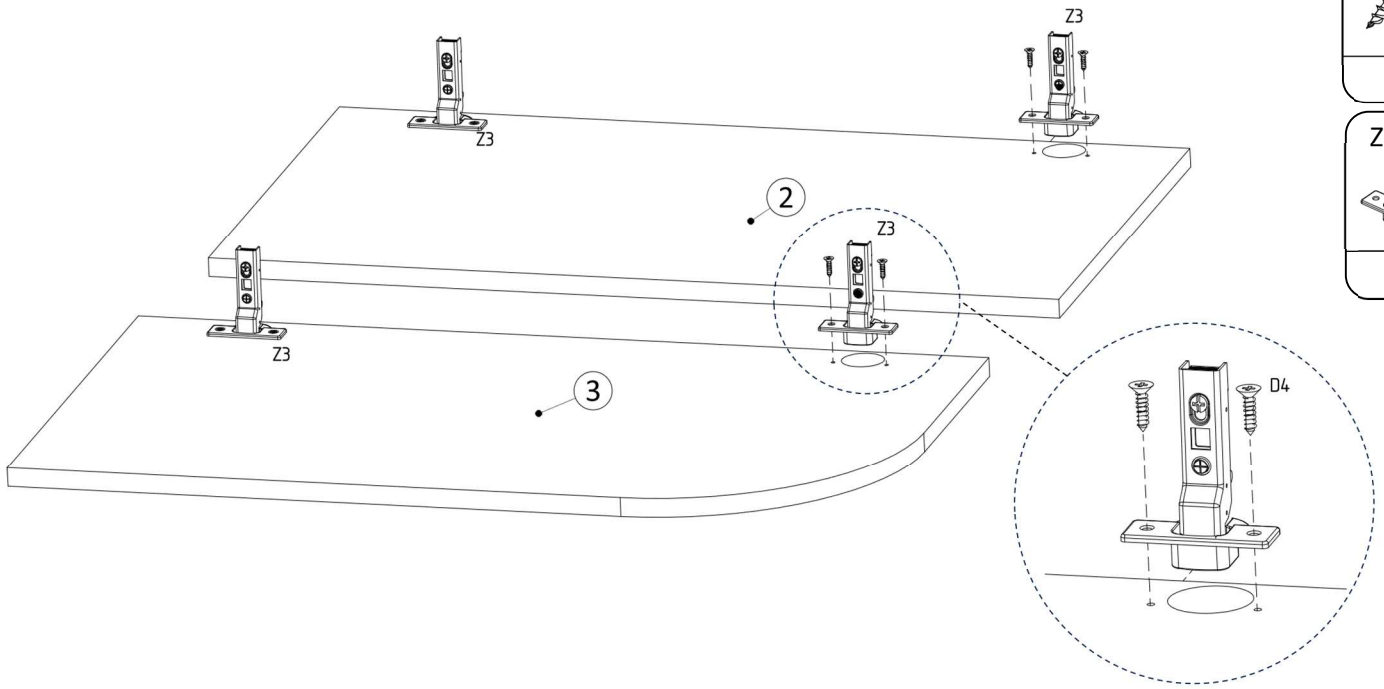

17

