

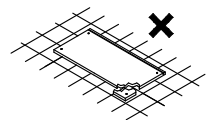

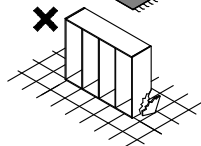

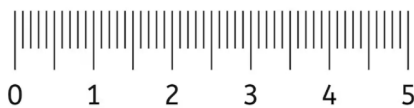

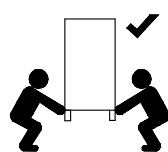
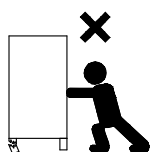
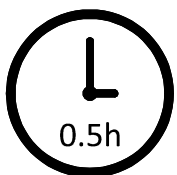
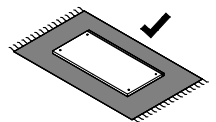
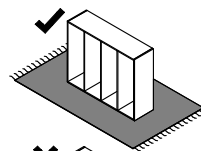
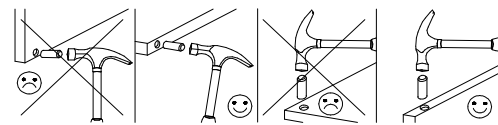
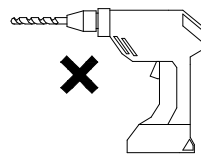
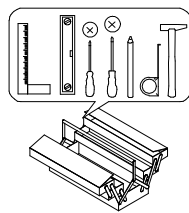
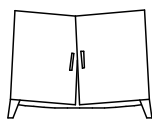
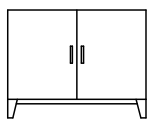
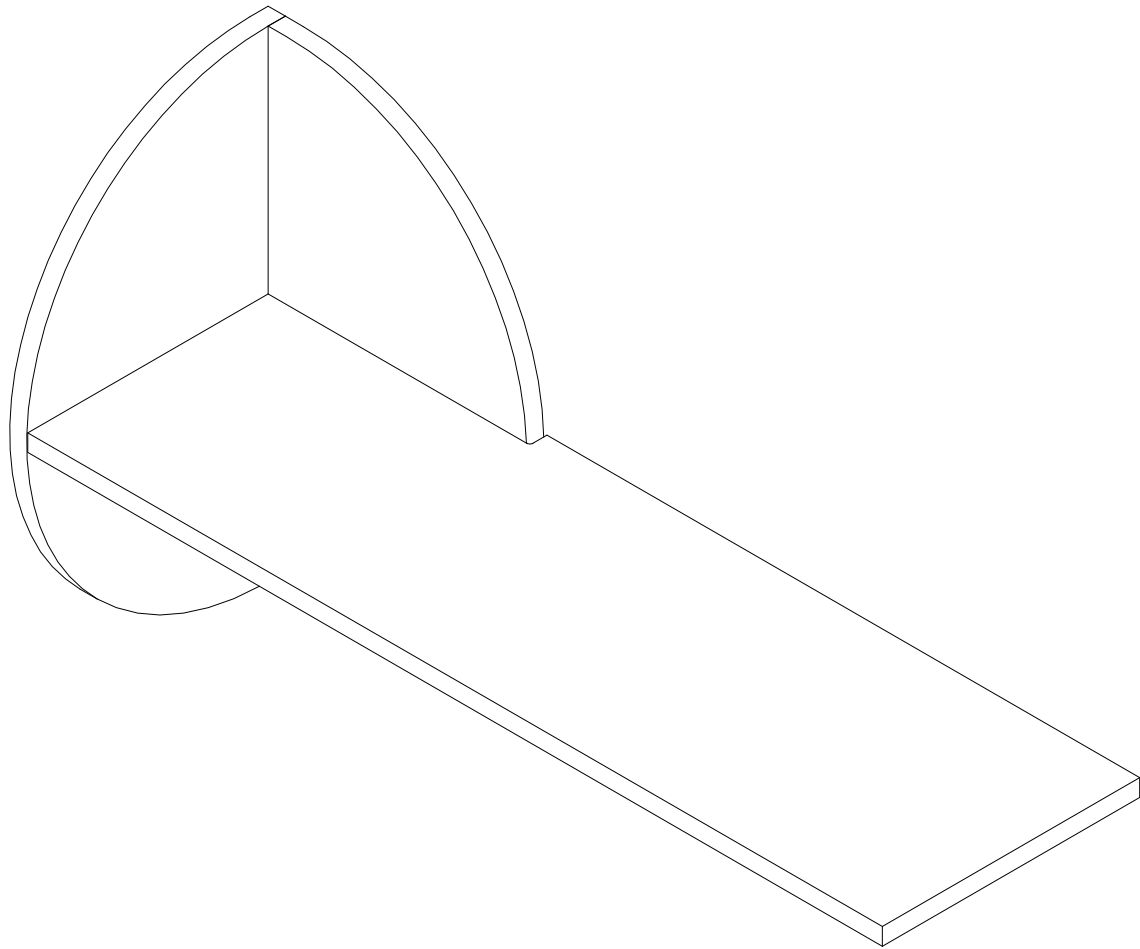
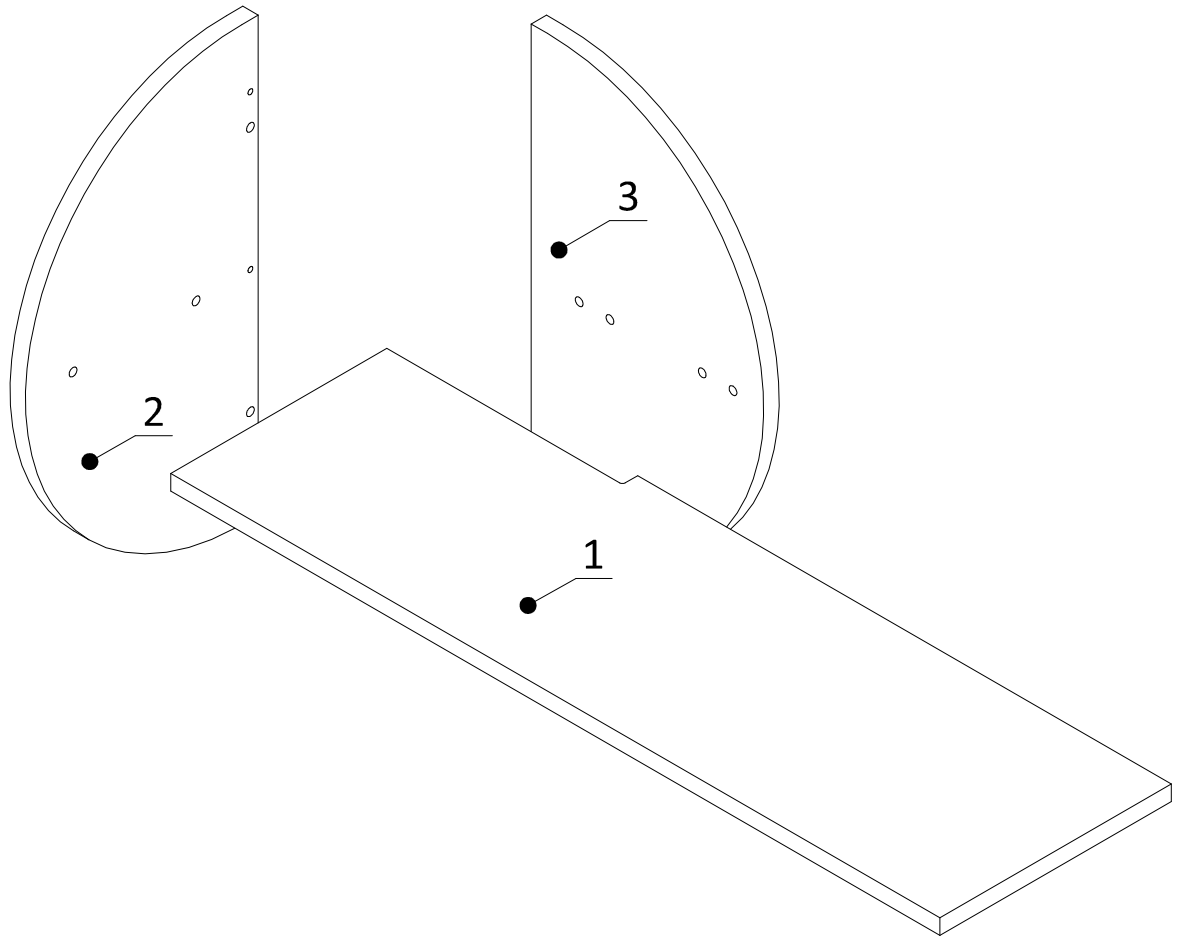
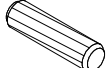

LEXI R-16

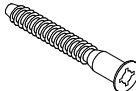

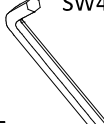

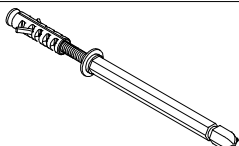

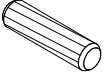

 <p>8x30</p> <p>K</p>	 <p>15/12</p> <p>M</p>	 <p>L20,3</p> <p>T</p>	 <p>7x50</p> <p>KF</p>	 <p>6,3x9</p> <p>E2</p>	 <p>SW4</p> <p>KL</p>	 <p>ZW</p>	 <p>R</p>
6x	3x	3x	2x	2x	1x	1x	1x

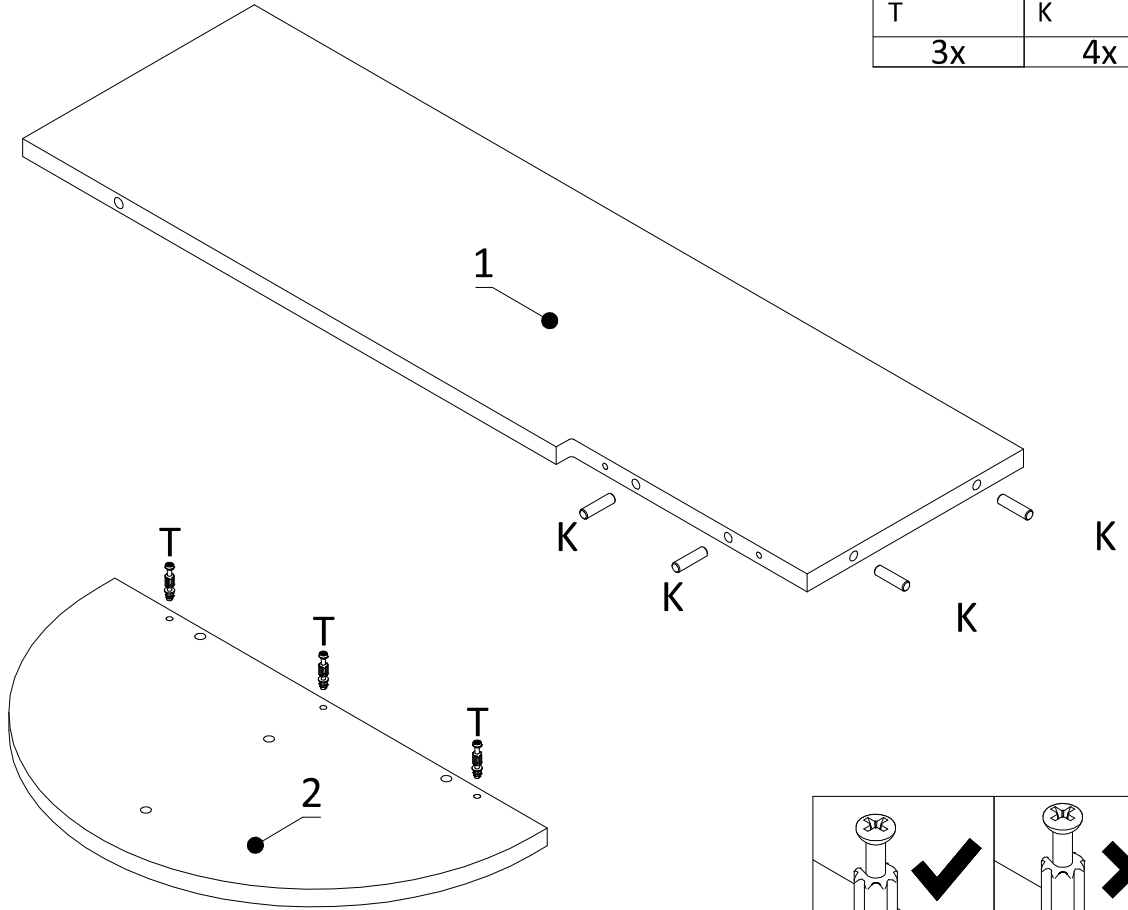
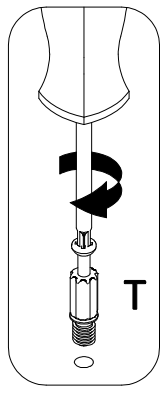
1

	
T	K
3x	4x

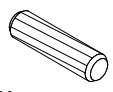

2

			
K	M	E2	ZW
2x	3x	2x	1x

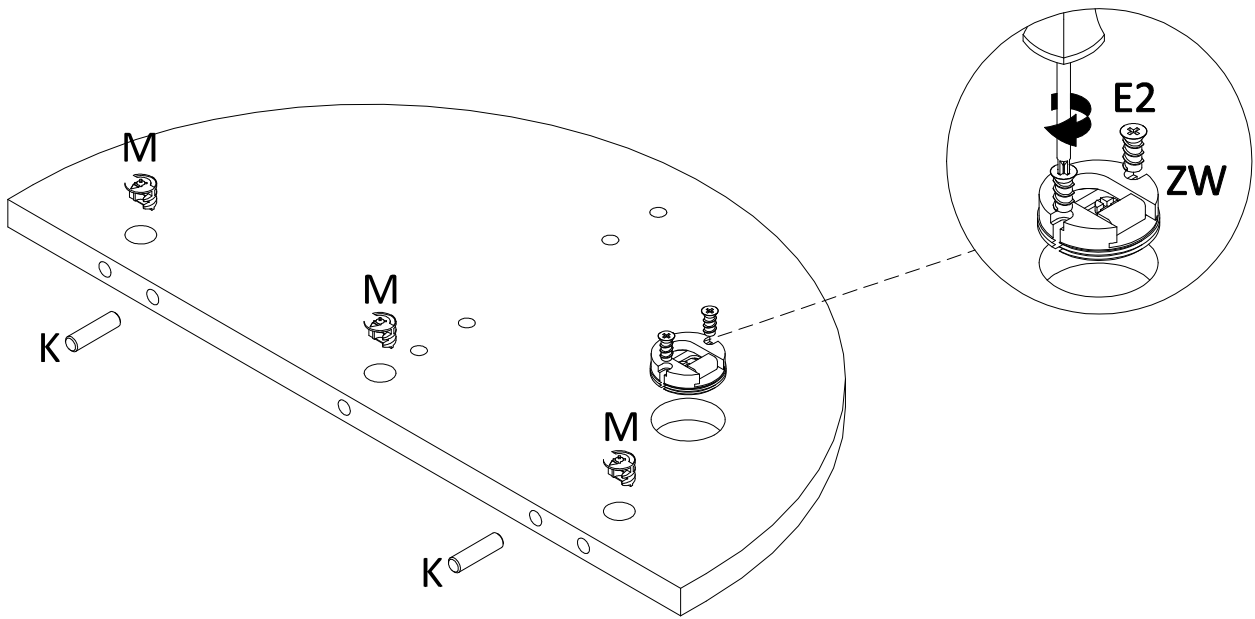

3

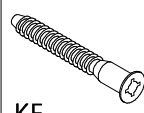
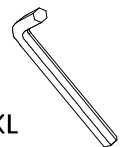
	
KF	KL
2x	1x

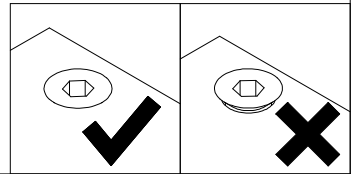
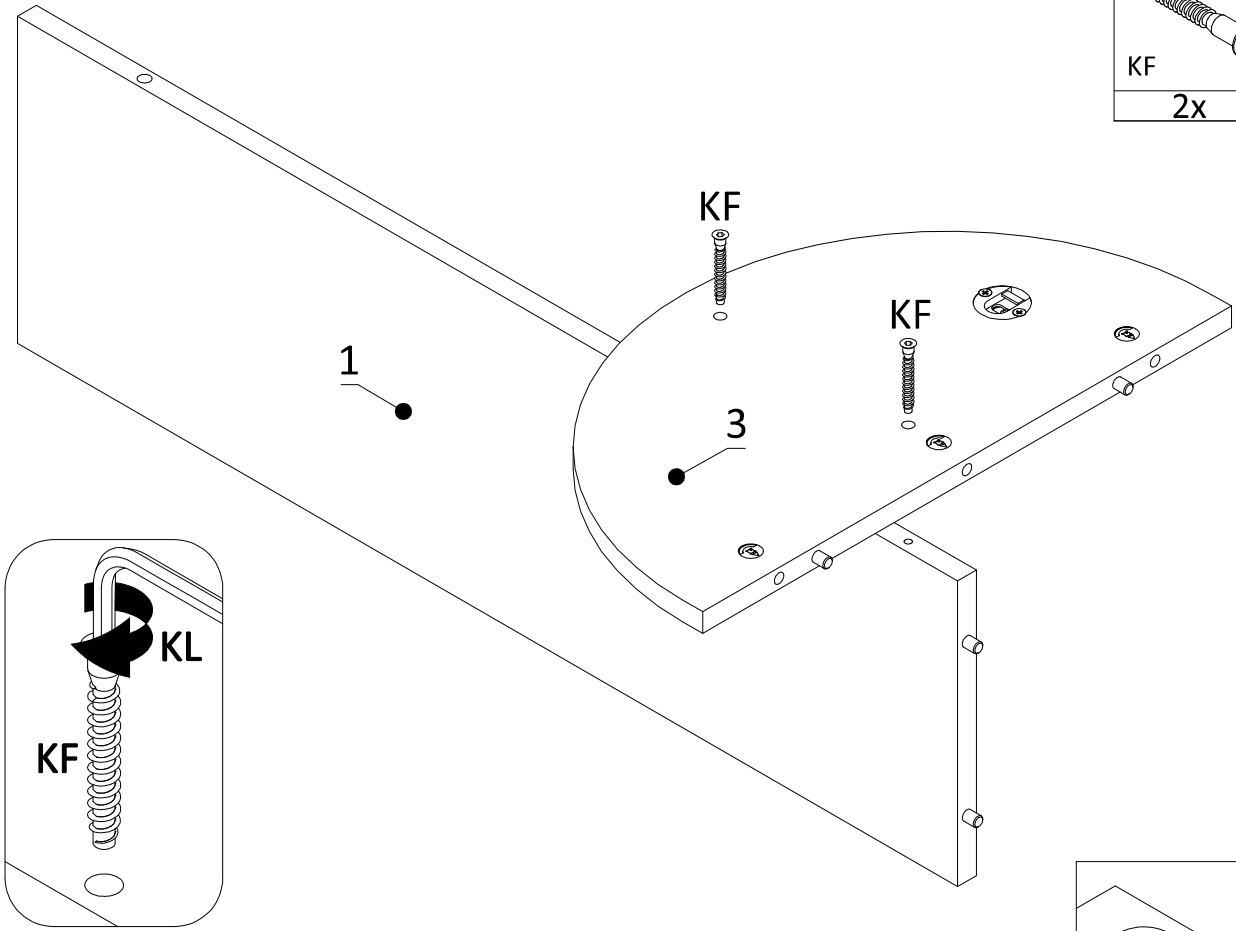

4

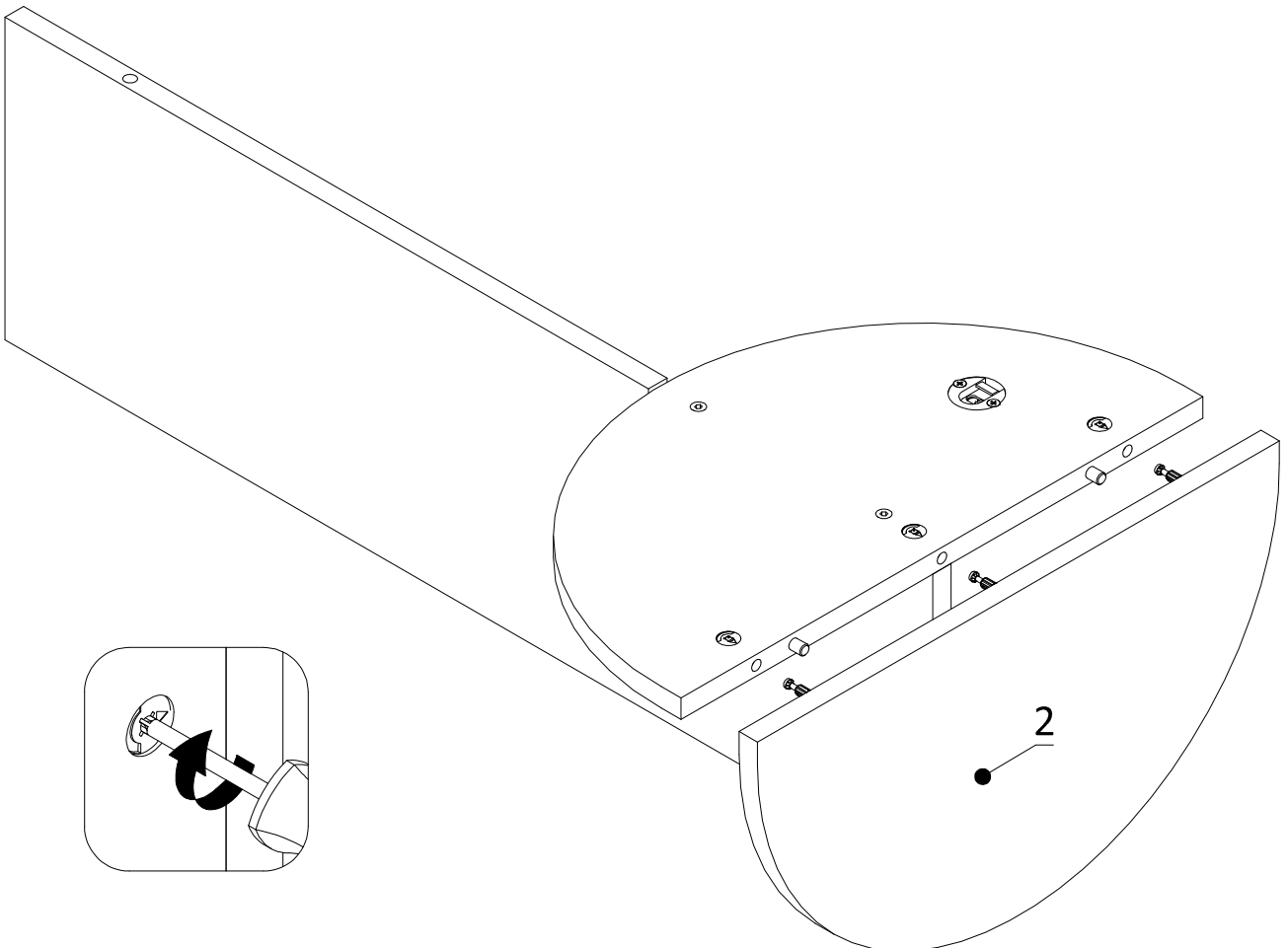

5

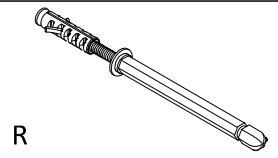
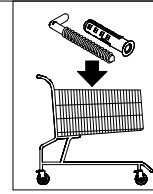
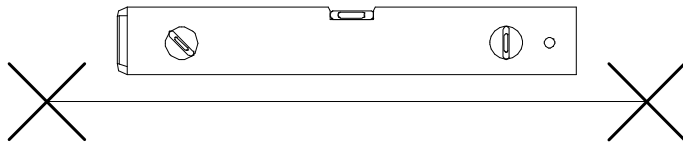

R

1x

1

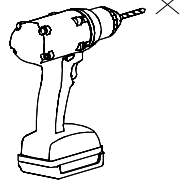

2

