

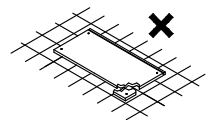

LEXI R-17

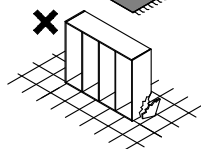

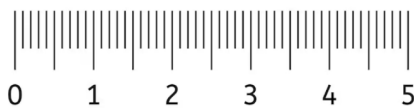

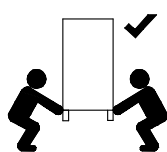
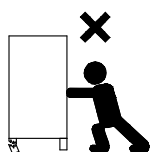
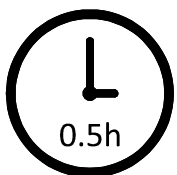
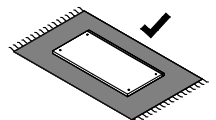
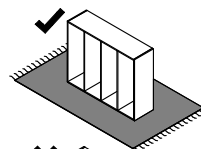
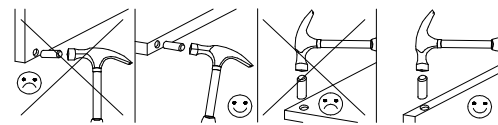
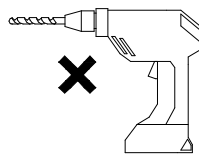
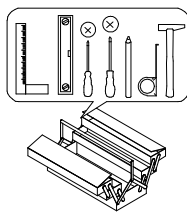
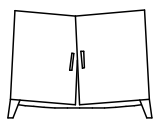
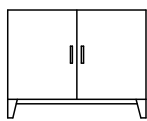
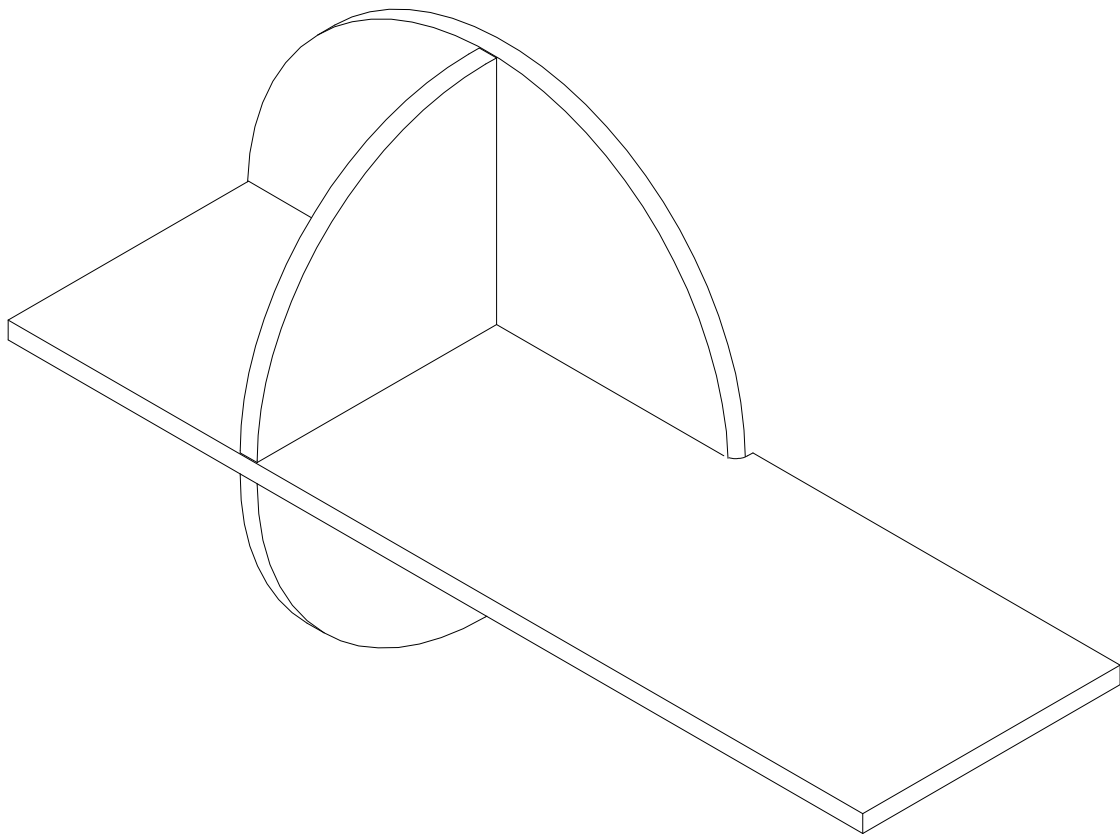
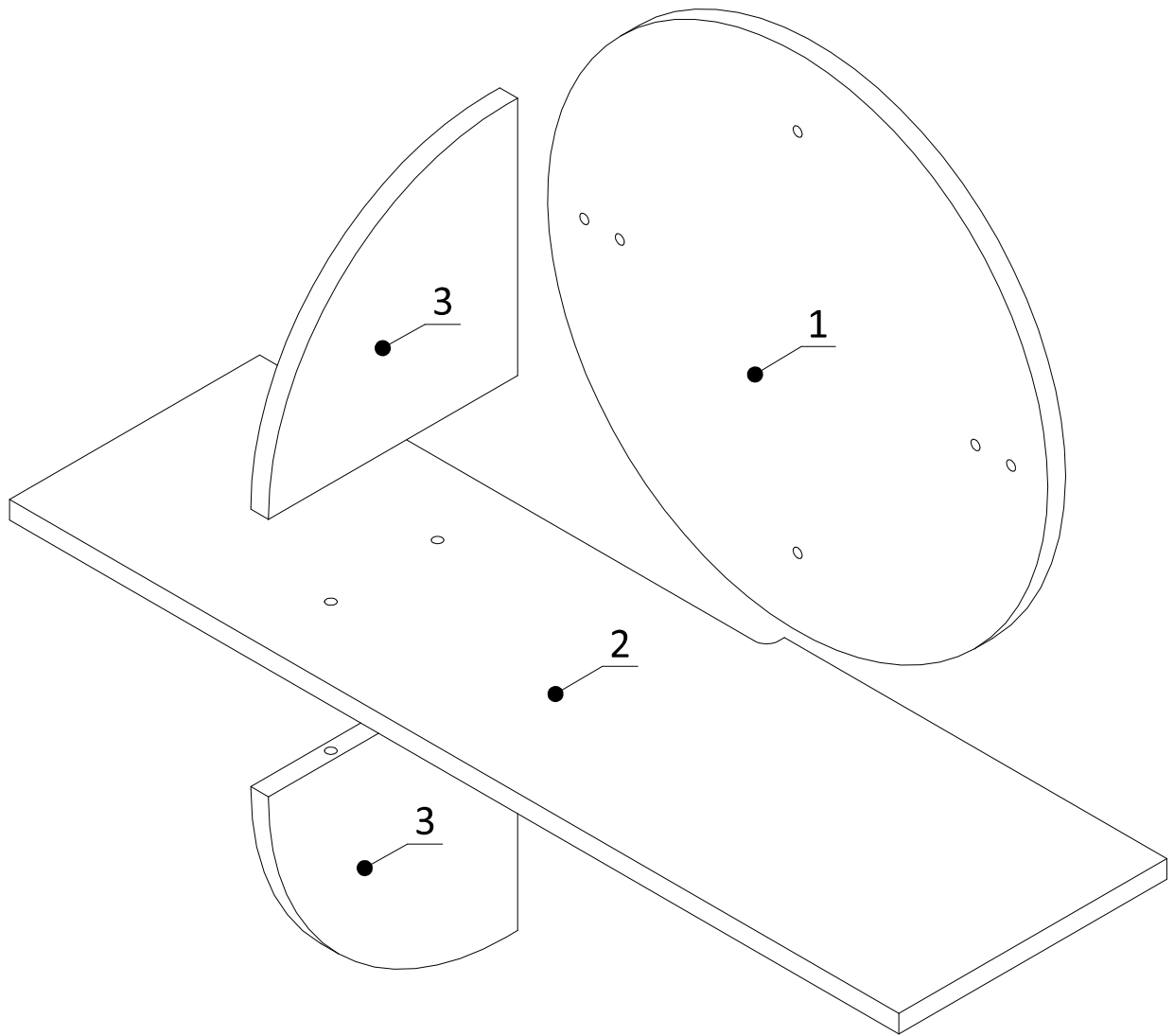

K 2x	K2 2x	KF 4x	E2 2x	KL 1x	ZW 1x	R 1x

1

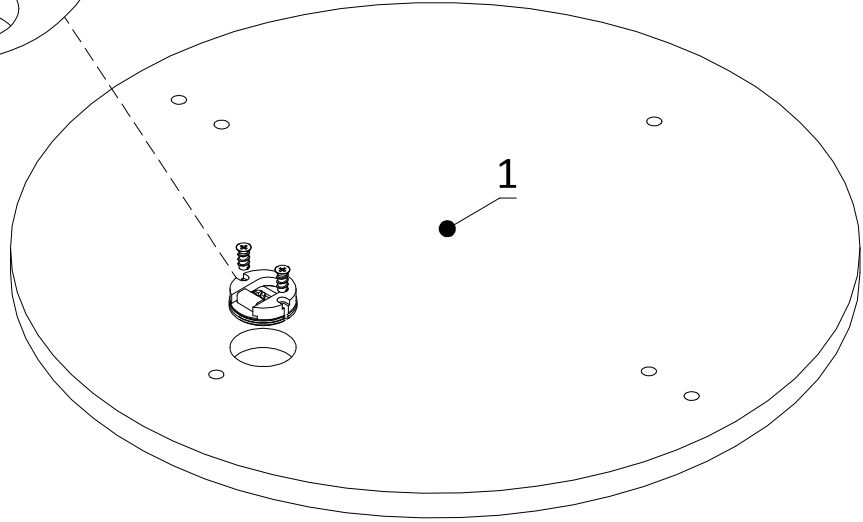
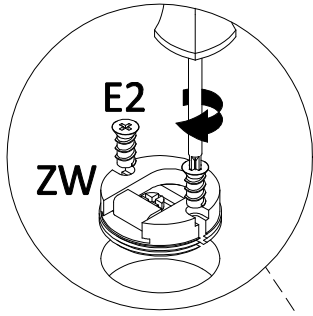
	
ZW	E2
1x	2x

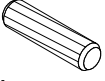

2

	
K2	K
2x	2x

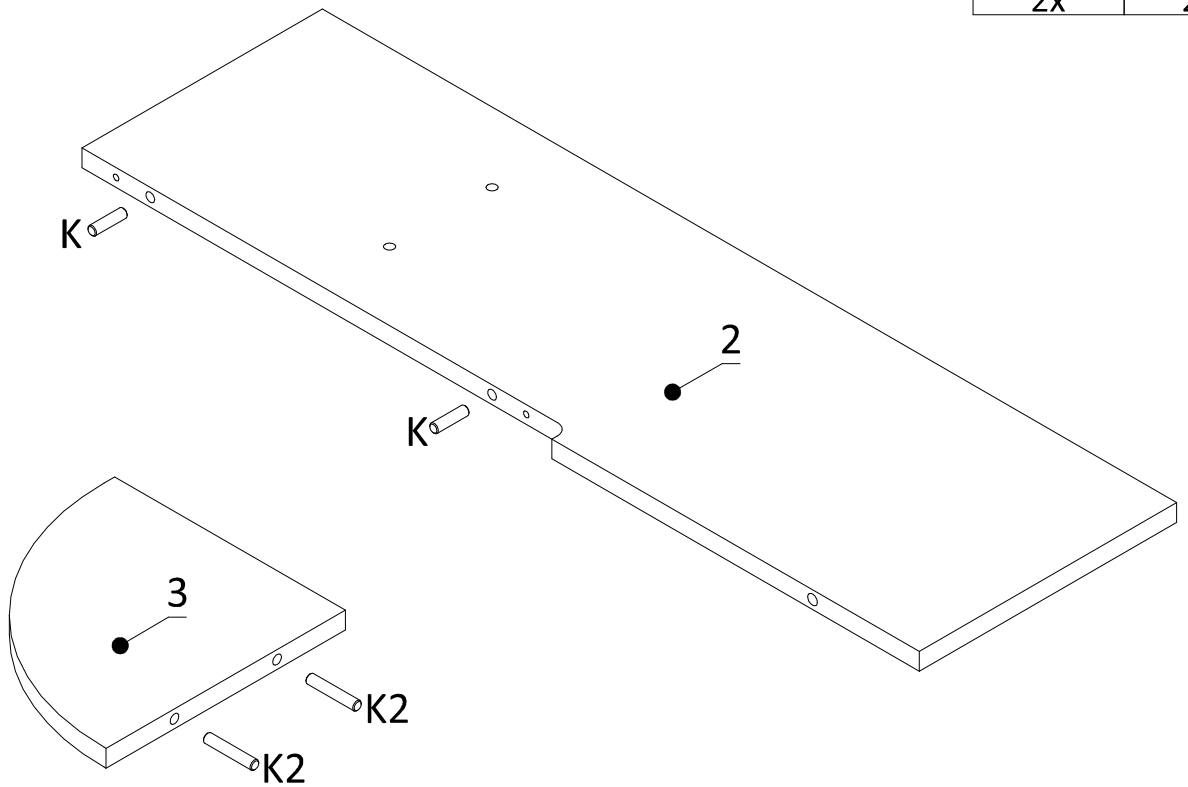

3

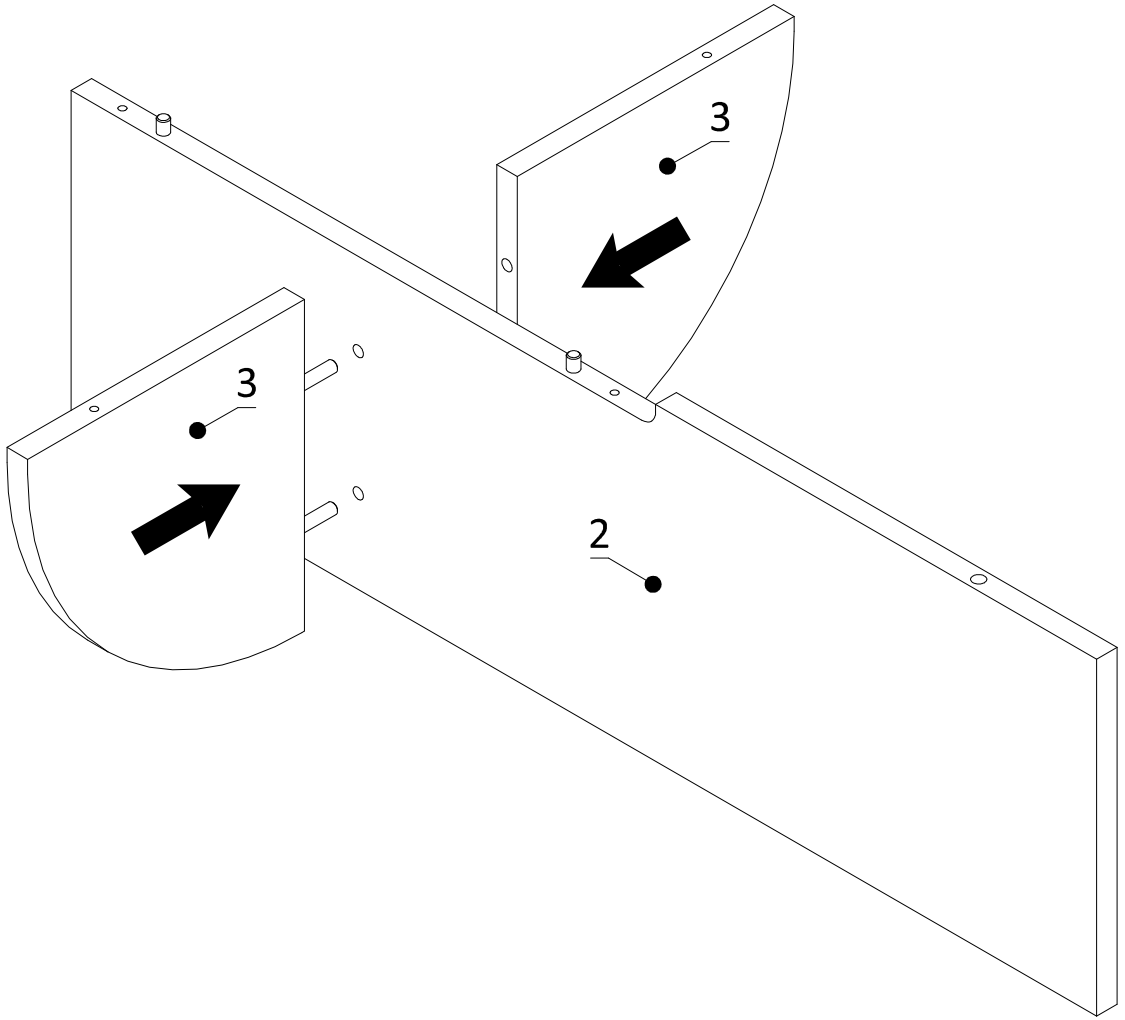

4

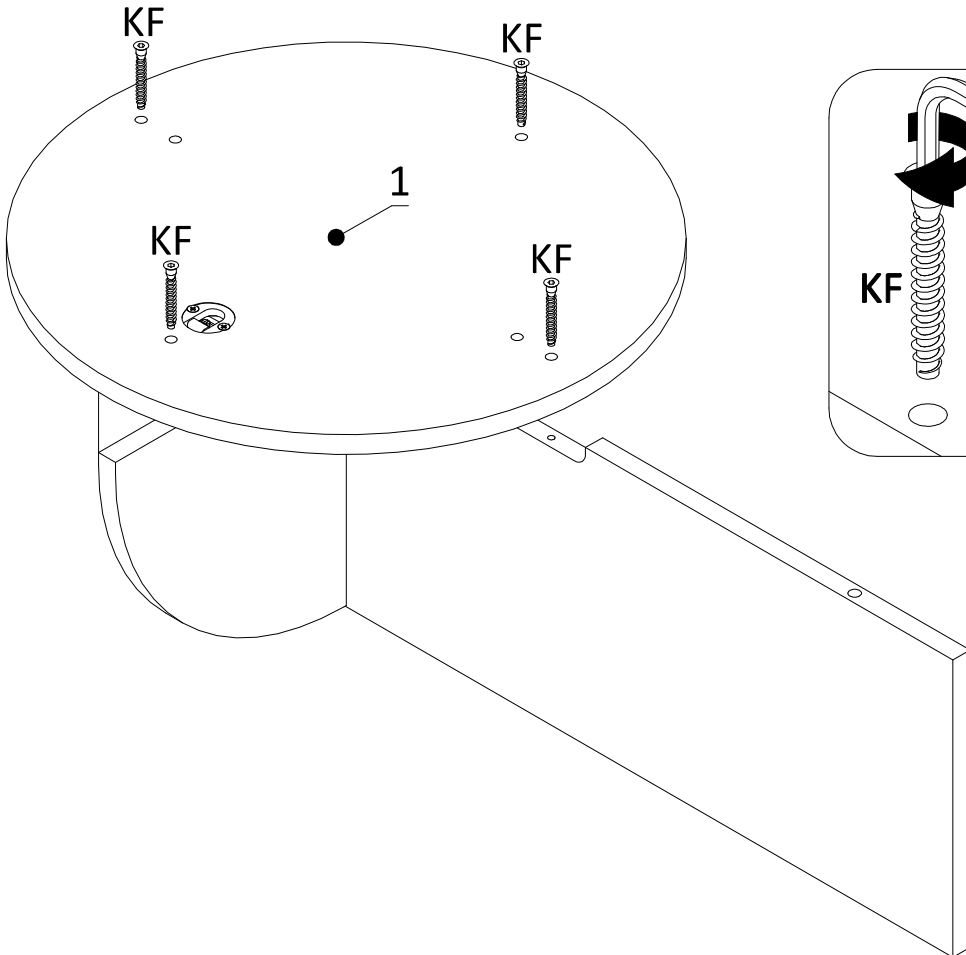

KL	KF
1x	4x

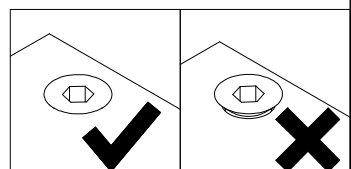

5

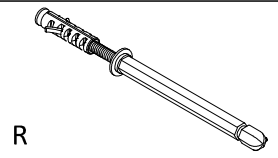
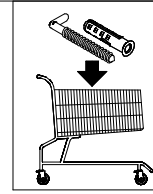
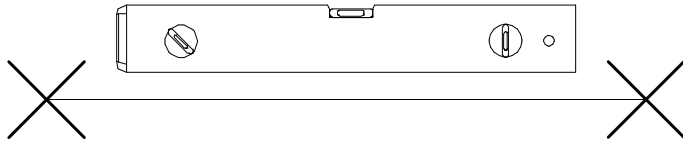

1x

