

QA - 03 REGAL 85

PL> INSTRUKCJA MONTAŻU
D >MONTAGEANLEITUNG
GB>ASSEMBLY INSTRUCTIONS

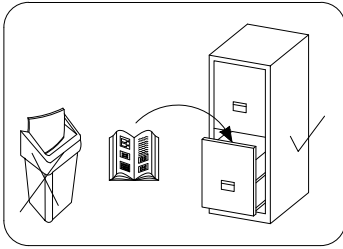

Czas montażu
 Montagezeit
 Time to assemble

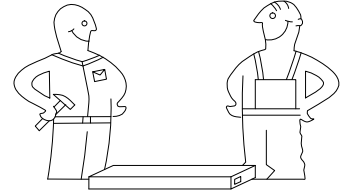
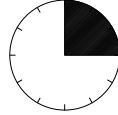

1 hours
 1 zeit
 1 godz.

Tools required narzędzia wymagane Werkzeuge erforderlich

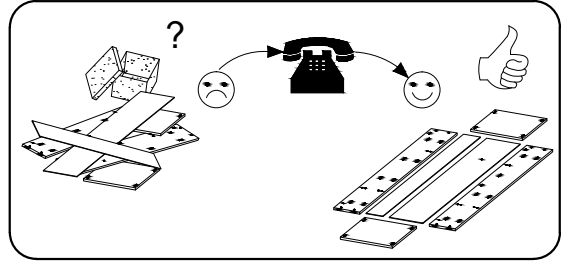
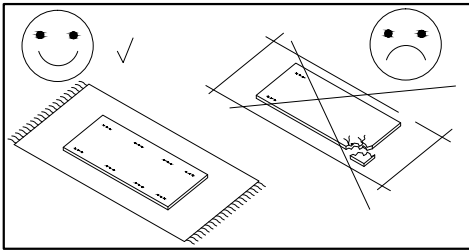
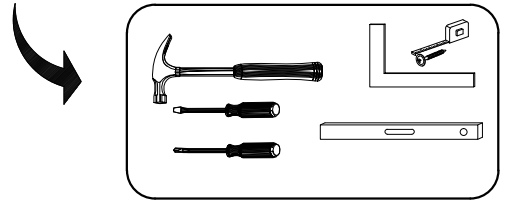

Uwaga / Achtung / Caution

PL>Czyszczenie należy wykonać wyłącznie za pomocą ściereczki lub lekko nawilżonego ręcznika.
 Nie stosować środków czyszczących do szorowania.

Szanowny kliencie, jeśli podczas montażu stwierdzisz uszkodzenie lub brak części, proszę podaj jej kod alfanumeryczny lub zaznacz ją na instrukcji montażu i prześlij wraz z protokołem reklamacyjnym

D >Bitte nur mit einem Staubtuch oder leicht feuchtem Lappen reinigen. Keine scheuerenden Putzmittel verwenden.

Sehr geehrter kunde, sollte ein teil fehlen oder beschädigt sein, kreuzen sie dies bitte deutlich auf der montageanleitung an und schicken sie die montageanleitung mit ein.

GB>Please only clean with a duster or a damp cloth. Do not use any abrasive cleaners.

Dear customer, should there be any piece missing or damaged, kindly mark this piece clearly on the attached assembly instructions and return them to us.

Karta serwisowa /Service Karte /Service card

AKCESORIA / ZUBEHÖR / ACCESSORIES

 D 36	 S 12	 X 26	 A 26	 B 26	 T2 40	 L 6	 "15" Z1 6	 L - 350 R 3
 3.5x16 H 36	 L - 160 F 4	 4.0x30 G 12	 3,0X20 H3 15	 L - 224 F1 2	 O 6	 Q 1		

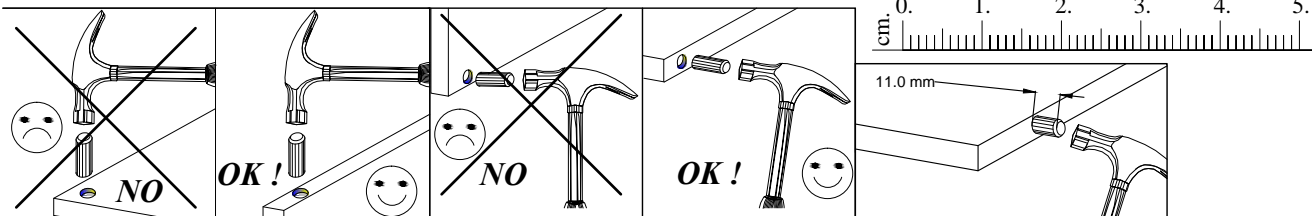



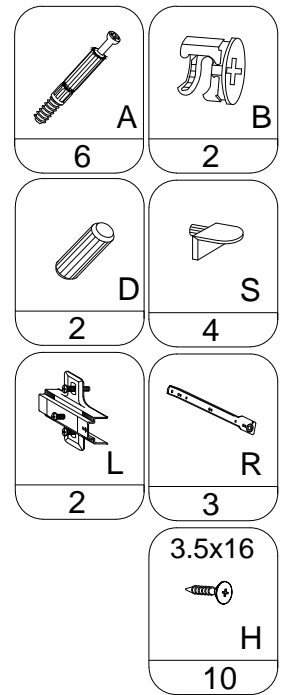
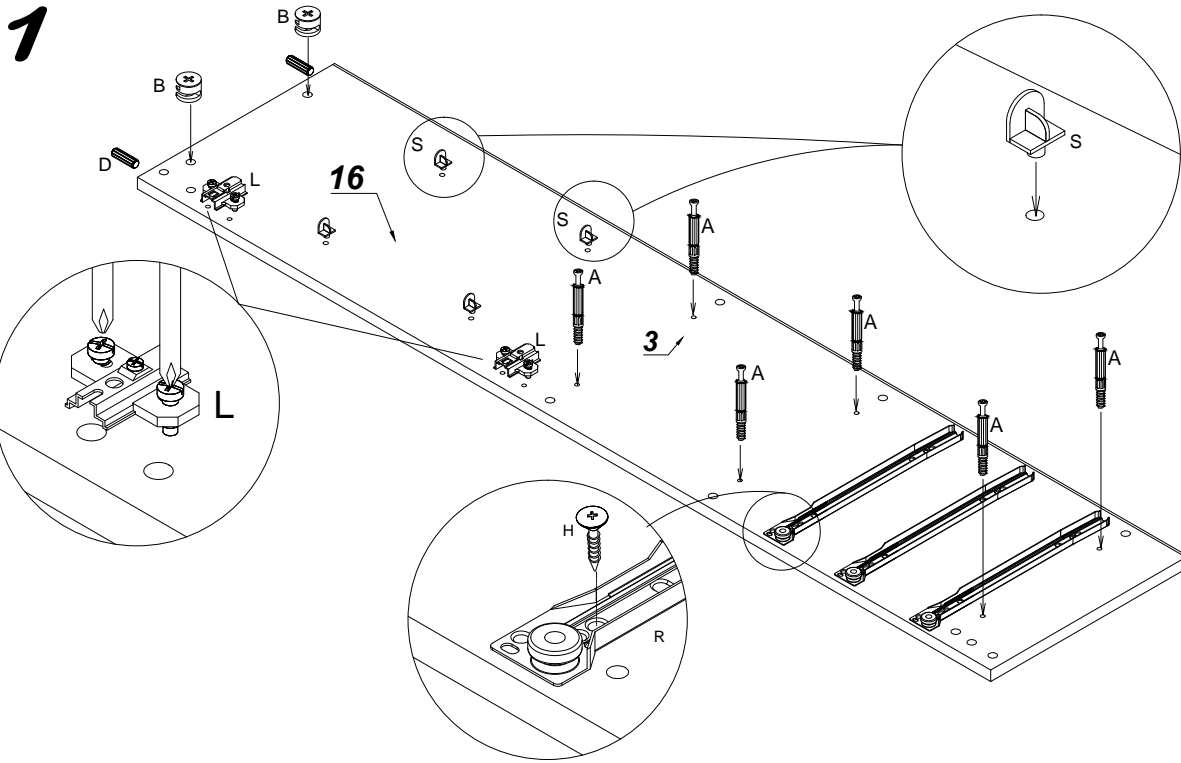
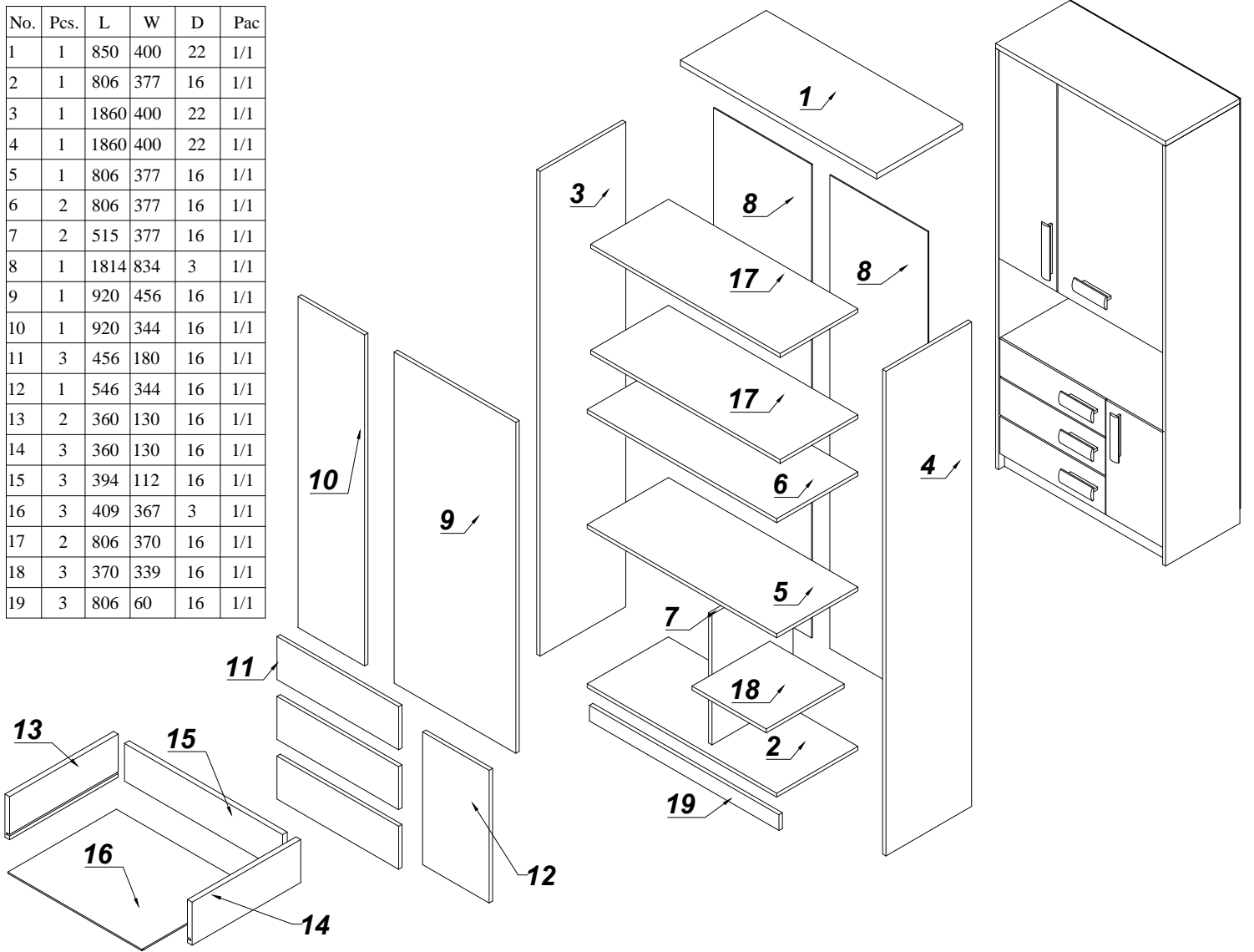

No.	Pcs.	L	W	D	Pac
1	1	850	400	22	1/1
2	1	806	377	16	1/1
3	1	1860	400	22	1/1
4	1	1860	400	22	1/1
5	1	806	377	16	1/1
6	2	806	377	16	1/1
7	2	515	377	16	1/1
8	1	1814	834	3	1/1
9	1	920	456	16	1/1
10	1	920	344	16	1/1
11	3	456	180	16	1/1
12	1	546	344	16	1/1
13	2	360	130	16	1/1
14	3	360	130	16	1/1
15	3	394	112	16	1/1
16	3	409	367	3	1/1
17	2	806	370	16	1/1
18	3	370	339	16	1/1
19	3	806	60	16	1/1

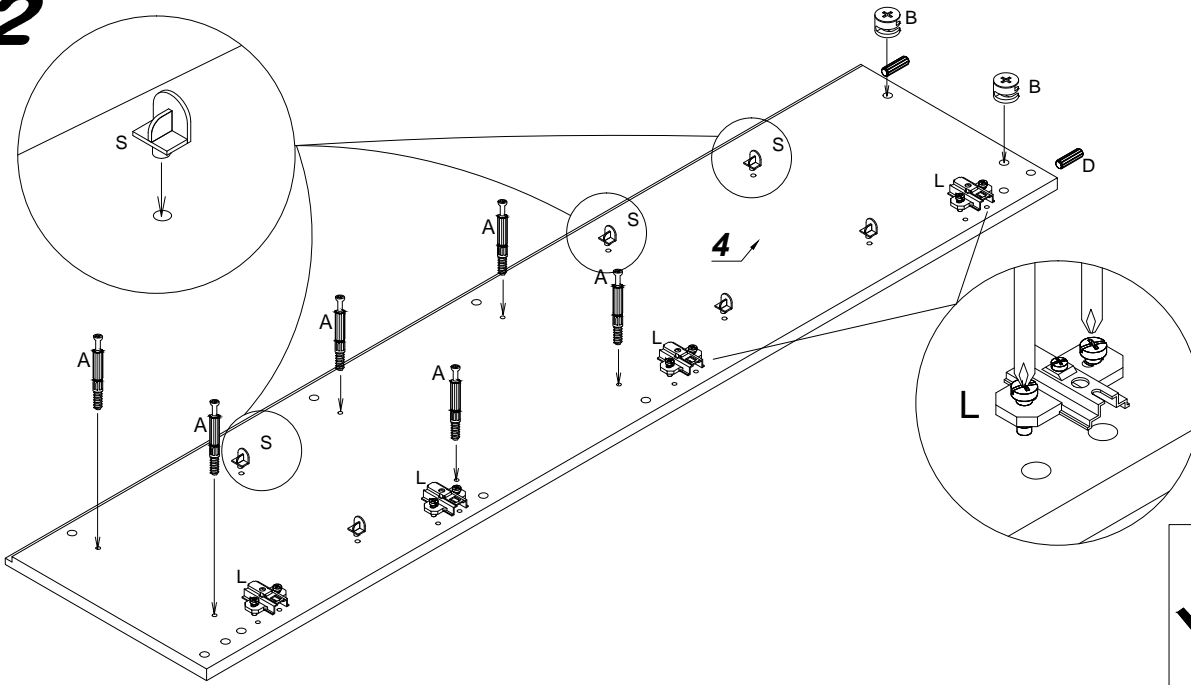



2



 A 6	 B 2
--	--

 D 2	 S 6
---	---

 L 4	 H 8
---	---

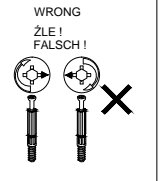
CORRECT OK! GUT!	WRONG ZLE! FALSCH!
	

3

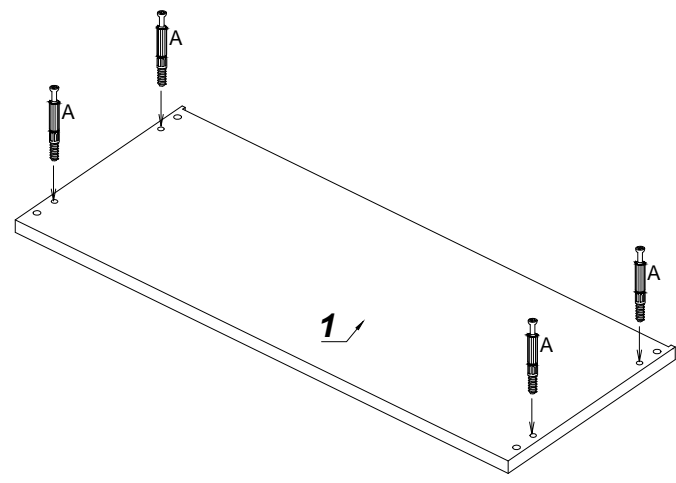

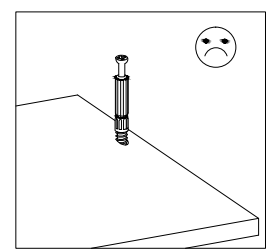
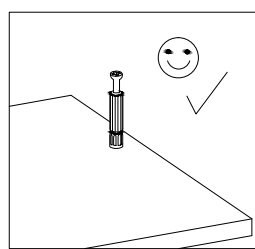

 A 4

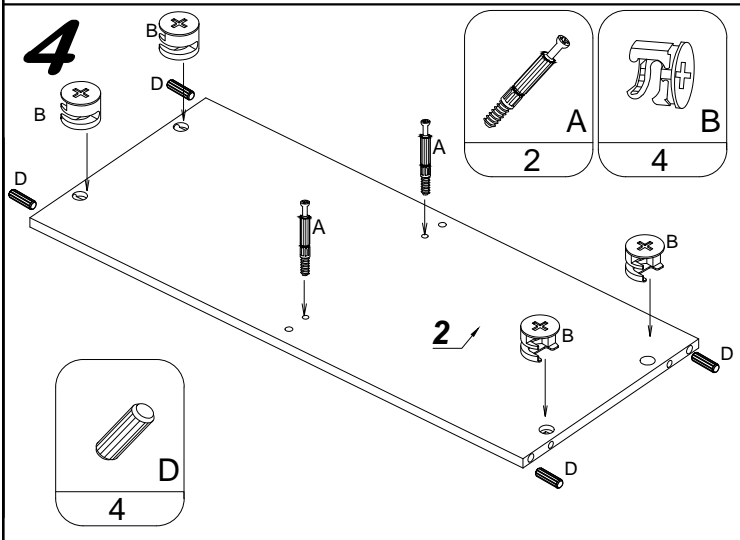

4





 A 2	 B 4
---	---

 D 4

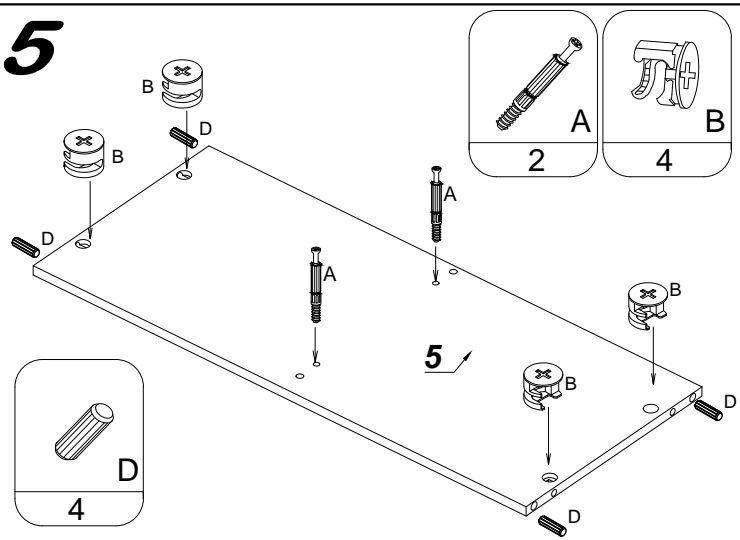
5

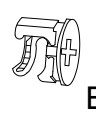



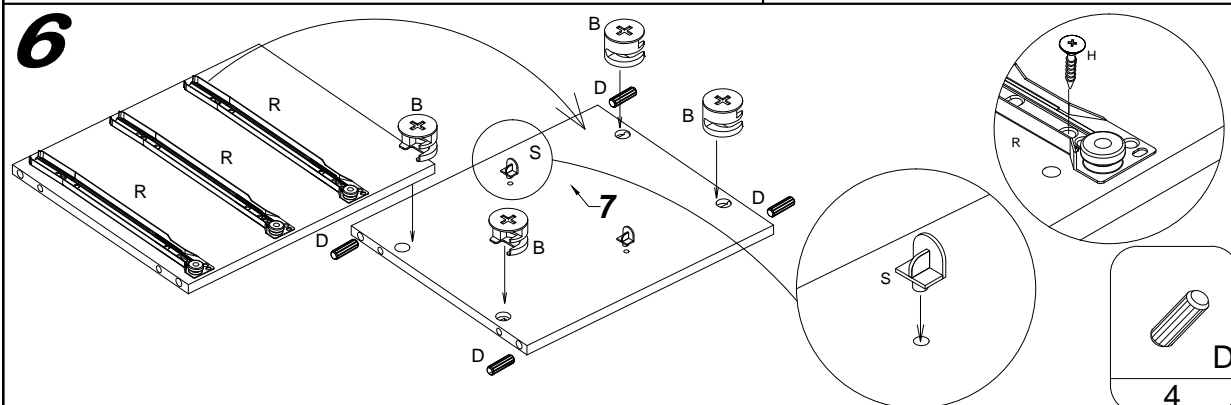

 A 2	 B 4
---	---

 D 4

6



 R 3	 B 4
---	---

 H 6	 S 2
---	---

 D 4

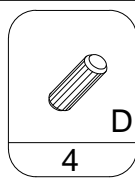
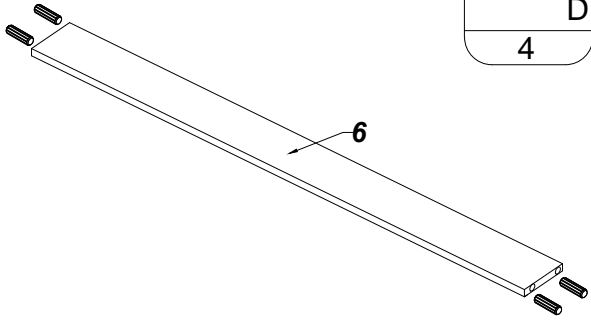
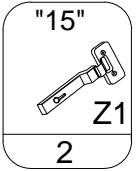
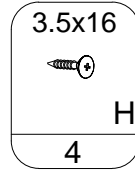
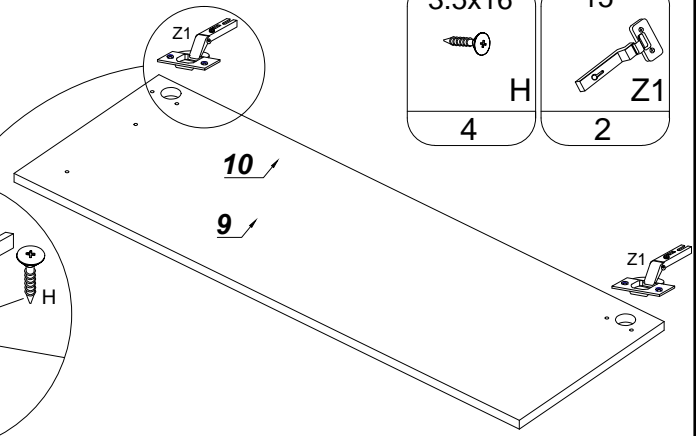
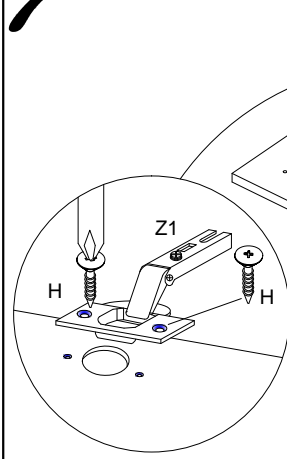
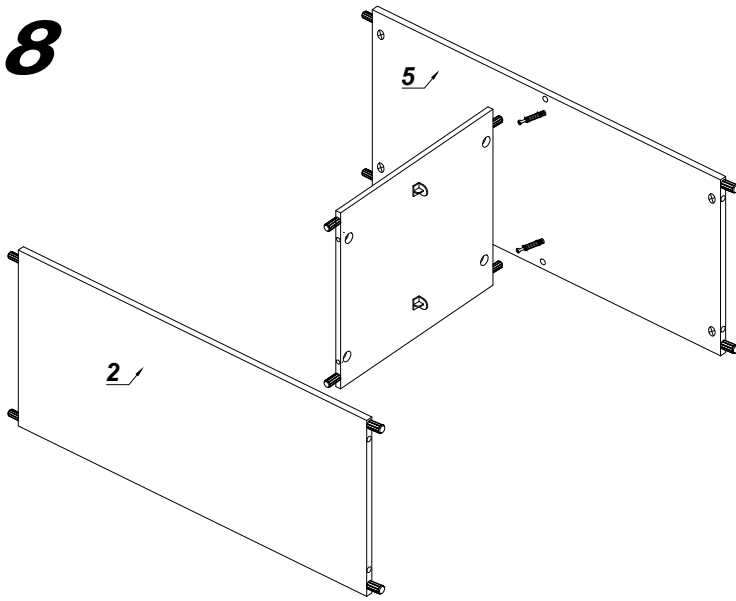
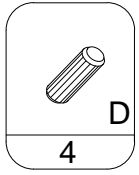
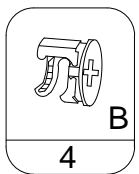
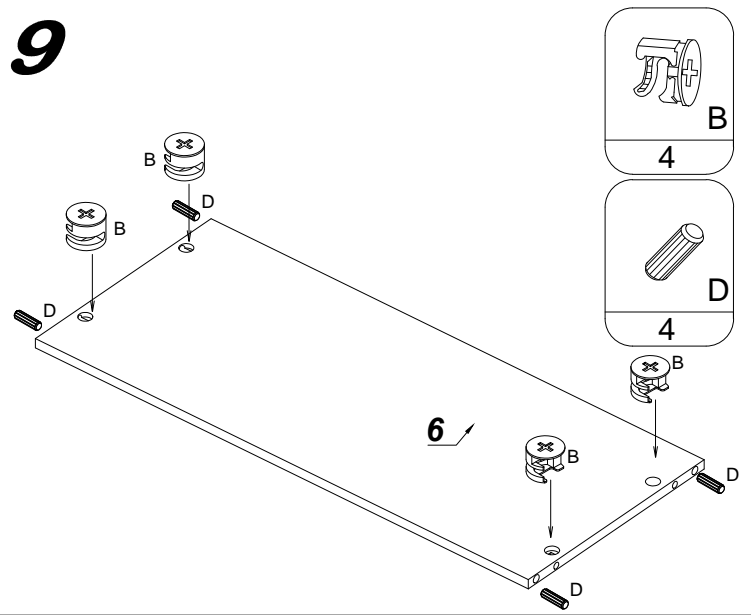
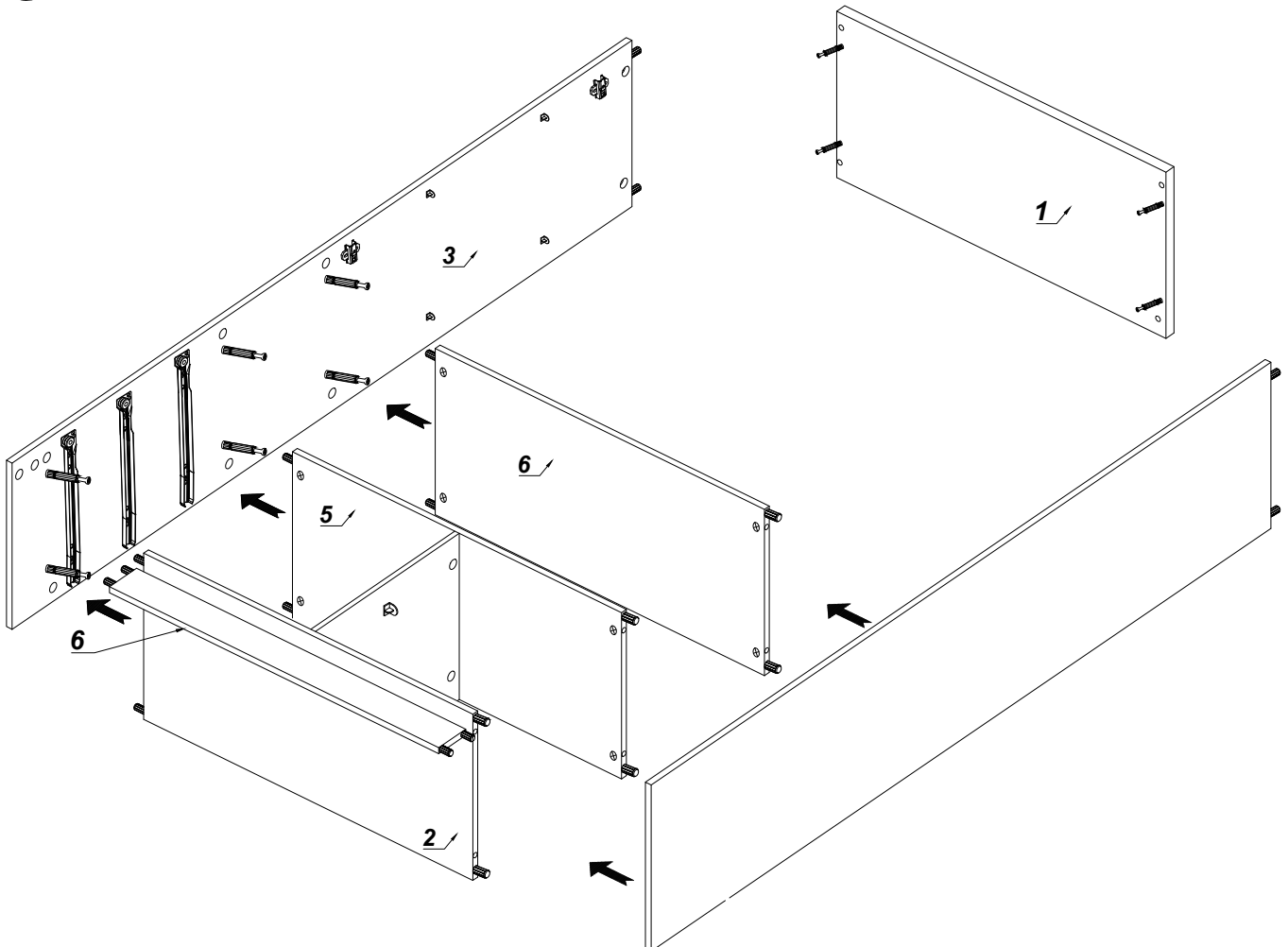
6**7****8****9****10**



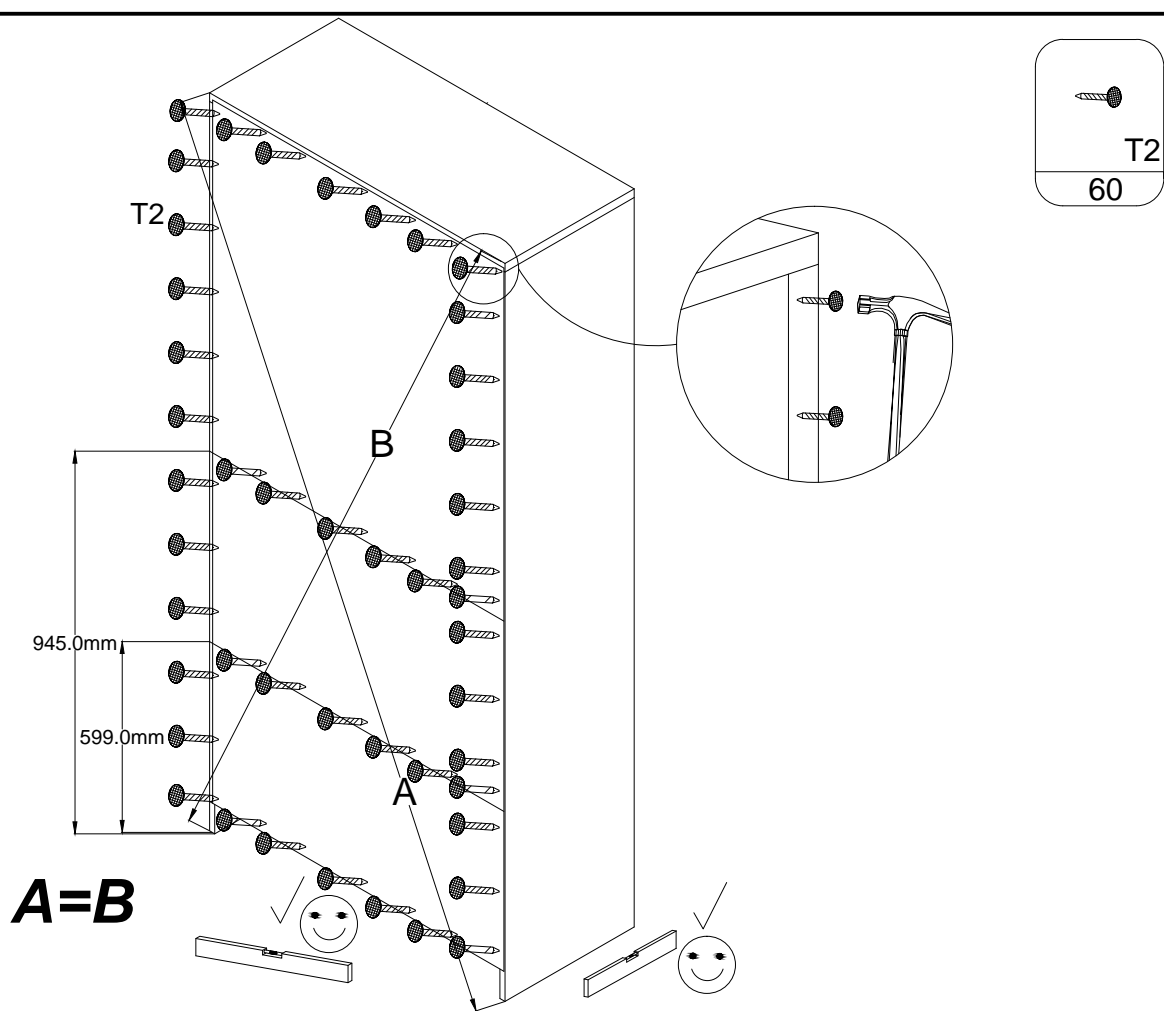



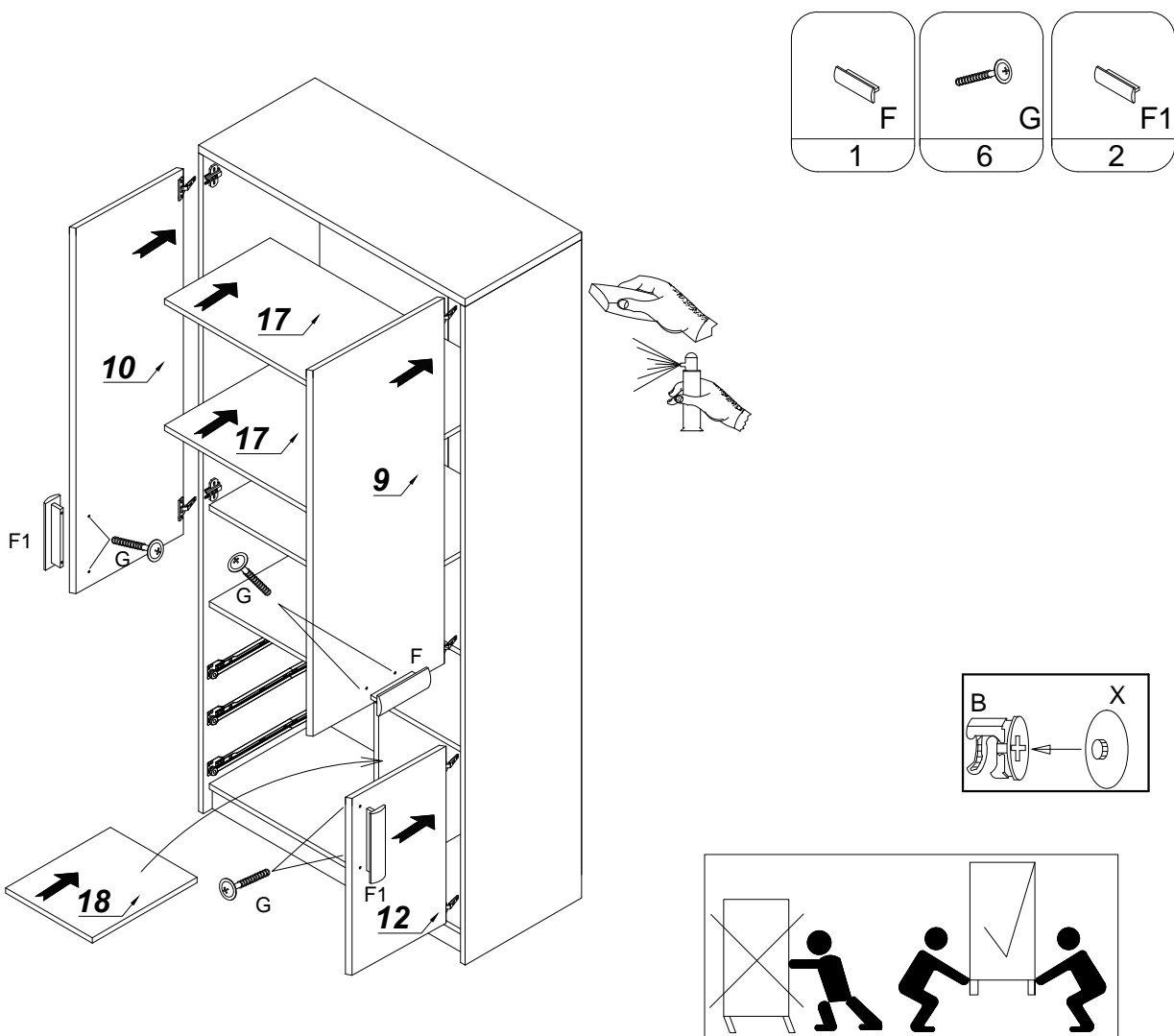

11





12

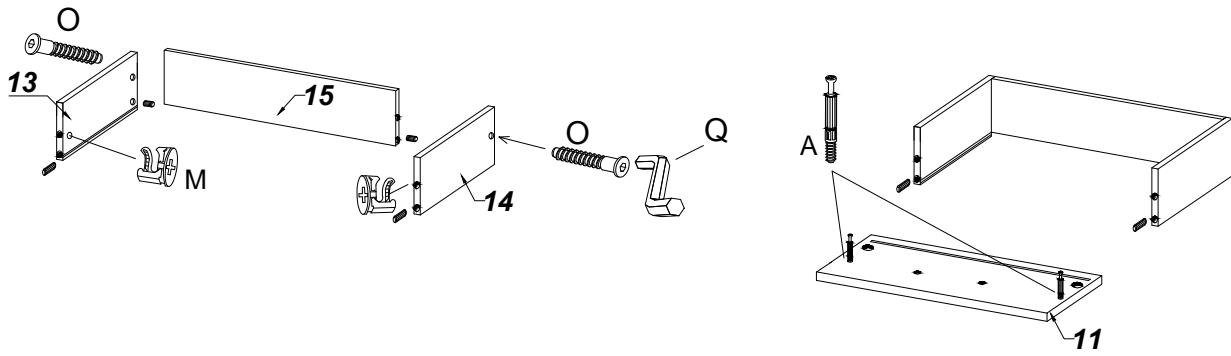

13

 O 6	 Q 1	 X 6	 3,0X20 H3 15	 3.5x16 H 24	 R 3	 D 12	 A 6	 B 6
--	--	--	--	--	--	---	--	--



 F 3
 G 6

