

PARIS

P-10

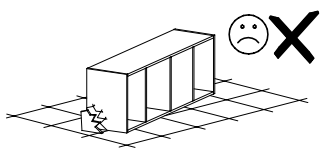

Narzędzia potrzebne do montażu

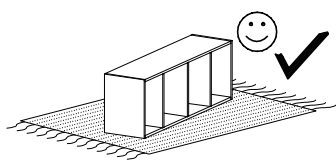
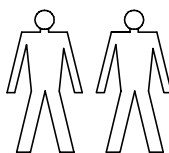
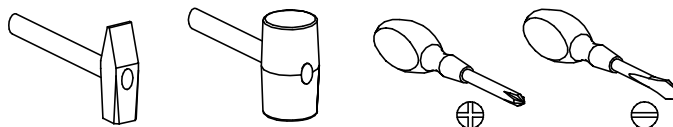

UWAGA !!

MONTOWANIE USZKODZONYCH
ELEMENTÓW POWODUJE UTRATĘ
GWARANCJI

nr	D[mm]	S[mm]	G[mm]	Ilość
1	1082	436	48	1
2	1082	436	48	1
3	1080	435	48	1
4	1047	388	16	1
5	1080	435	48	1
6	532	388	16	1
7	532	388	16	1
8	1070	378	2,5	3
9	534	487	16	2
10	534	487	16	2

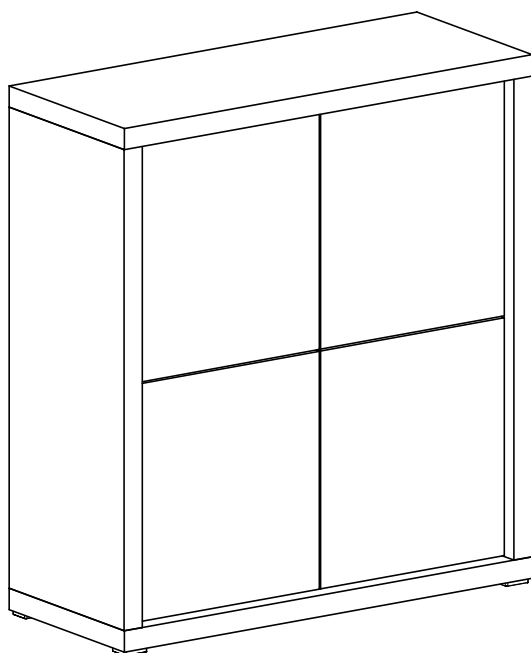

W przypadku reklamacji proszę o podanie numeru pakowacza znajdującego się na kartonie

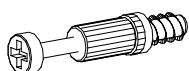

K - 16 St.

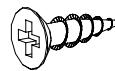

G - 24 St.
3,5 x 16 mm



L - 16 St.



E - 60 St.



N - 10 St.
3 x 25 mm

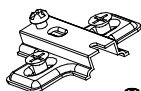

C - 8 St.

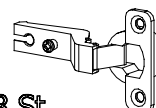

D - 8 St.

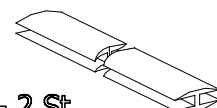

H - 2 St.

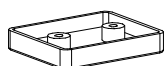

A - 5 St.



B1 - 16 St.



B2 - 2 St.

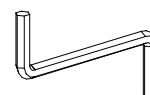

Z - 1 St.

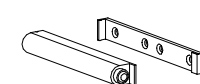

F - 4 St.

I

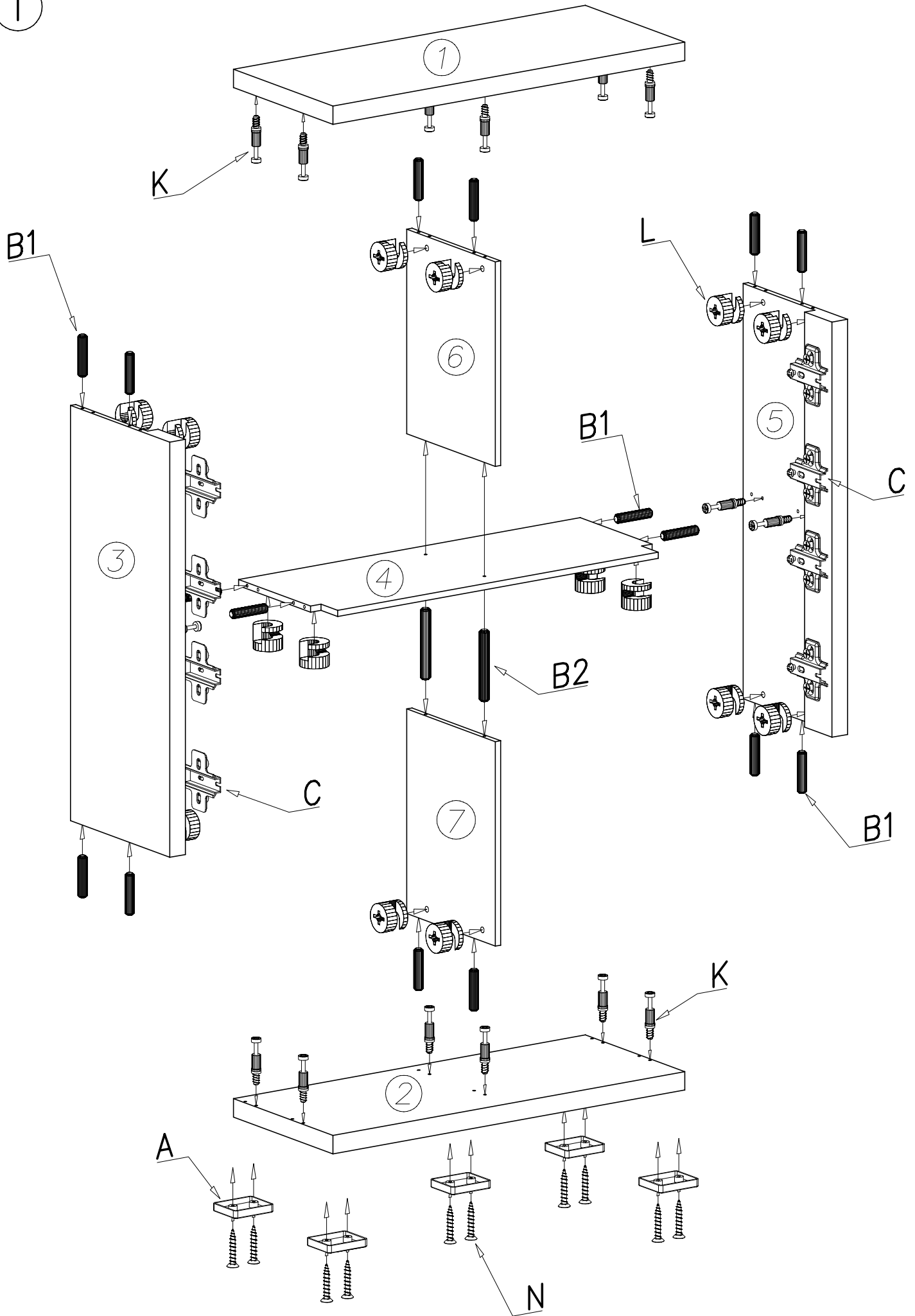

II

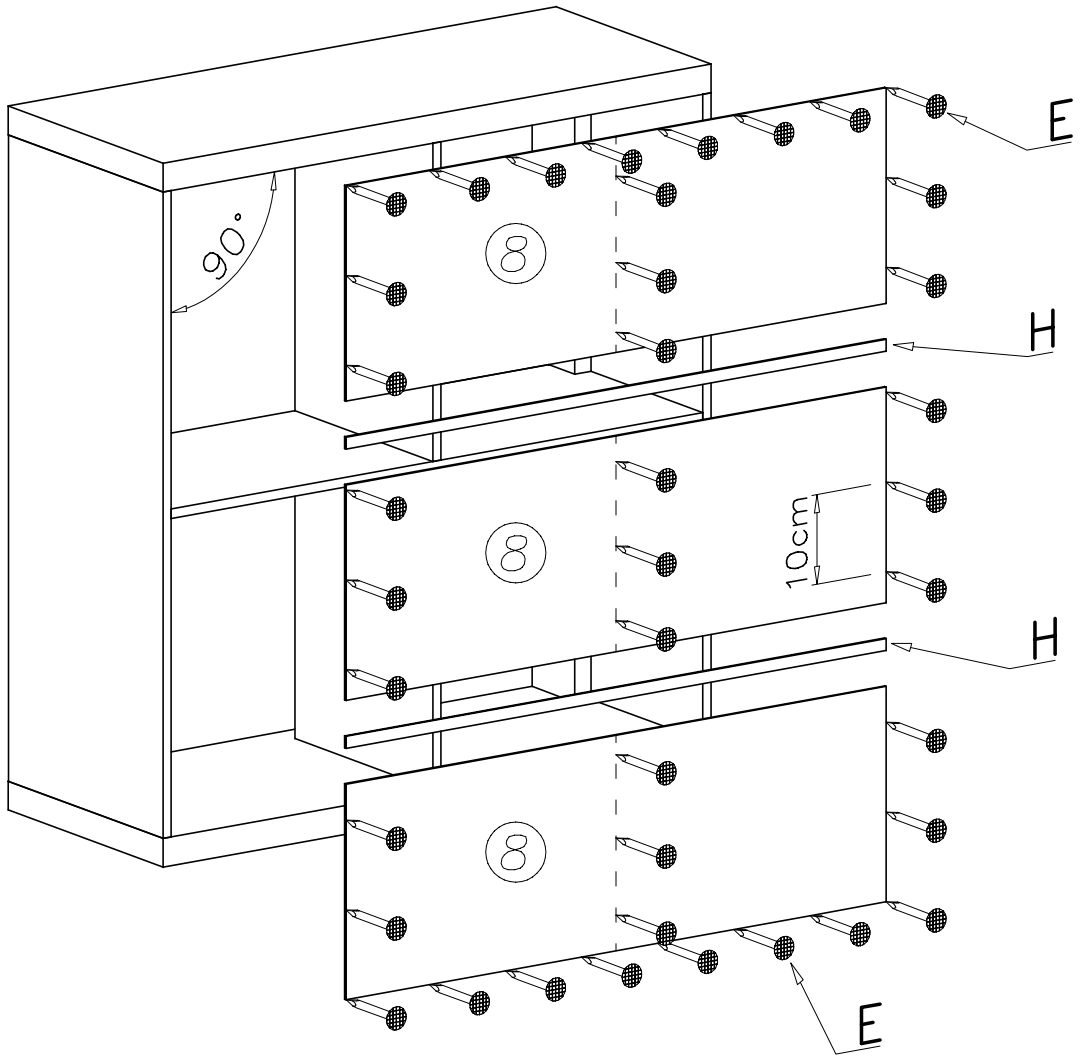

III

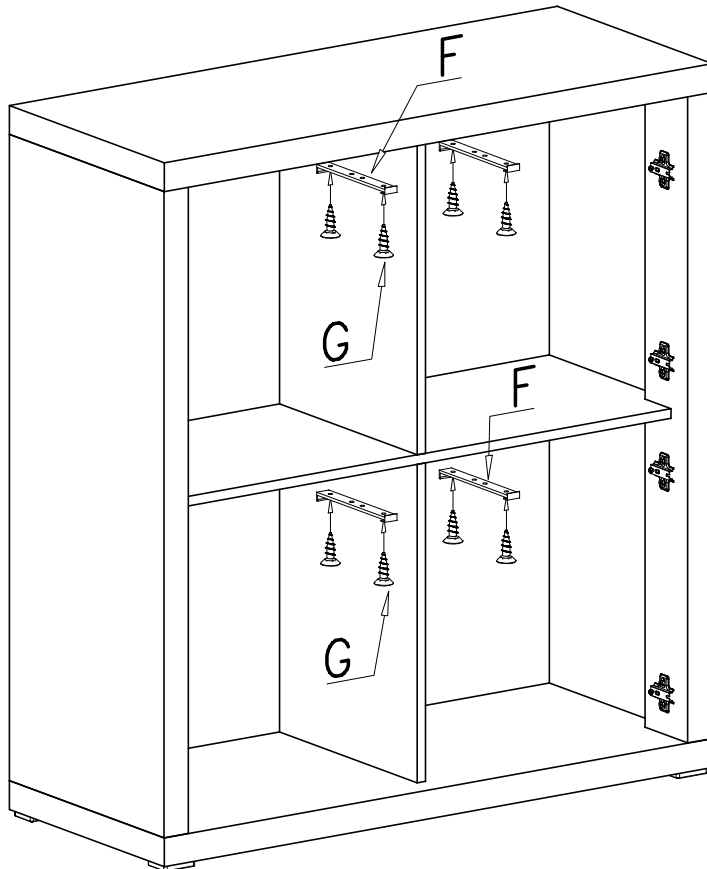

IV

