

PRZED ROZPOCZĘCIEM MONTAŻU ZAPOZNAĆ SIĘ Z INSTRUKCJĄ

Narzędzia niezbędne do montażu (nie dostarczane przez producenta)

Półka 42x42

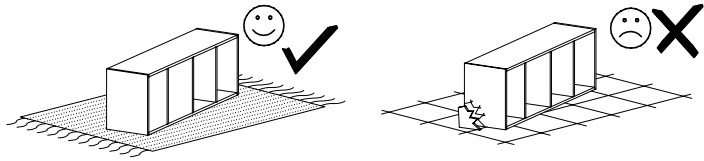

MONTOWAĆ NA MIEKKIM PODŁOŻU TYPU: KOC, DYWAN.

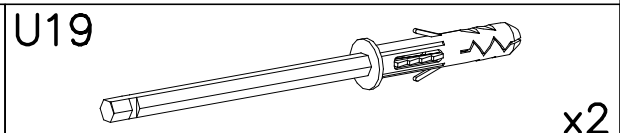
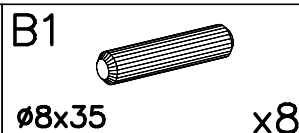
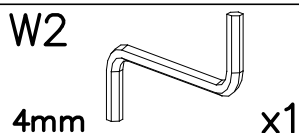
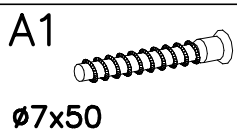
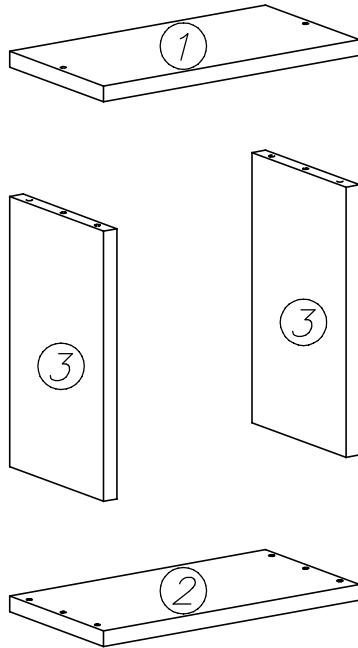
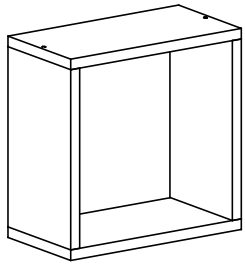
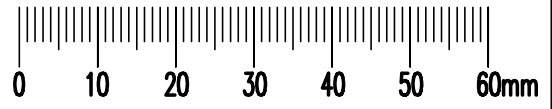
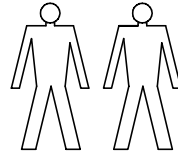
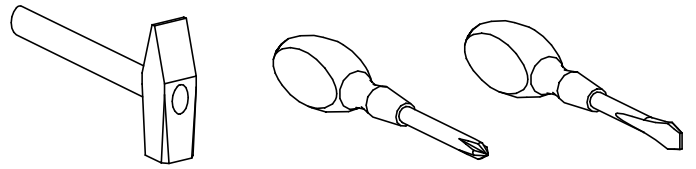

1

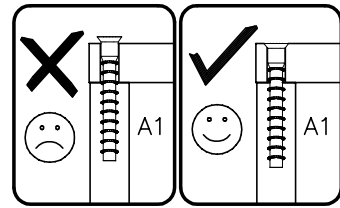
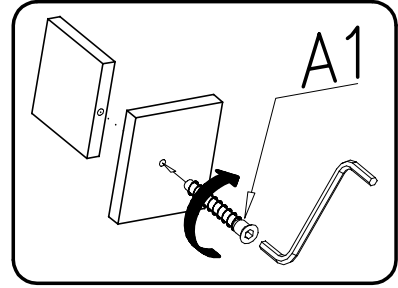
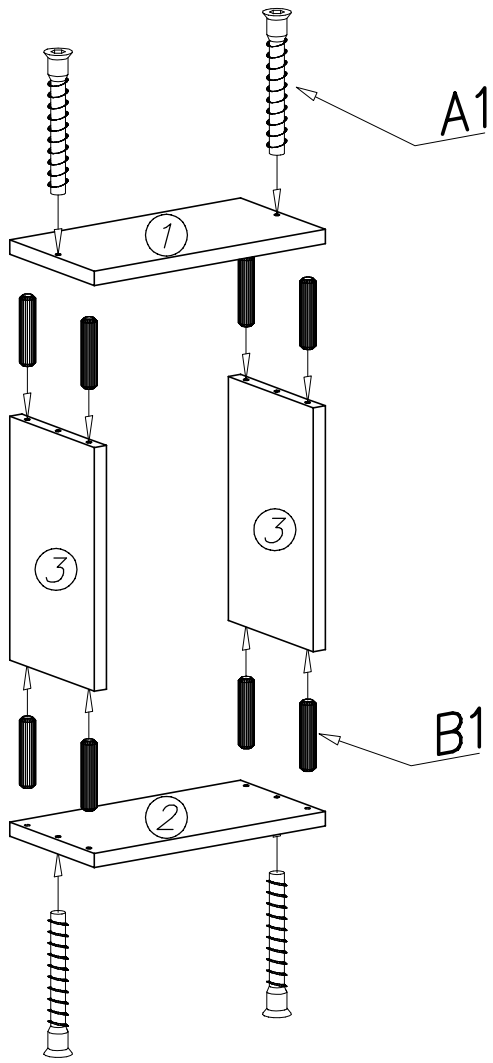

2

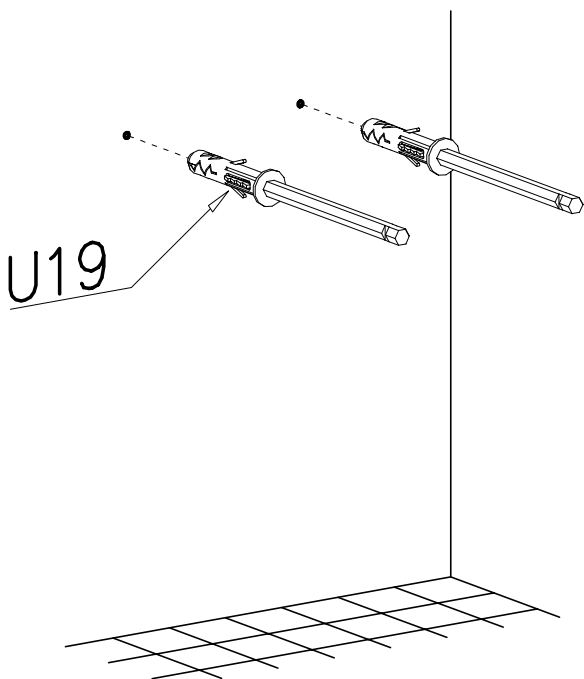

3

