

# MILLO

## MWTD50

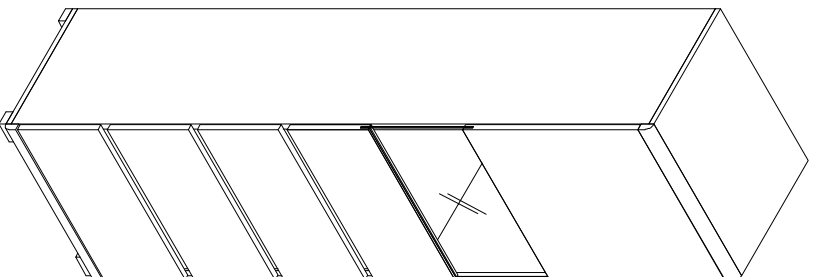

8.1.2018

- (D)** Montageanleitung
- (FR)** Notice de montage
- (NL)** Handleiding voor de montage
- (CZ)** Montážní návod
- (HU)** Szerelési útmutató
- (TR)** Montaj talimatı
- (GB)** Assembly Instructions
- (IT)** Istruzioni di montaggio
- (PL)** Instrukcja montażu
- (SK)** Návod na montáž
- (RO)** Instrucțiunile de montaj
- (RU)** Инструкции по монтажу

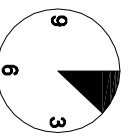
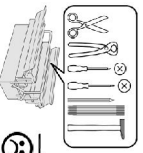

20 min.

1

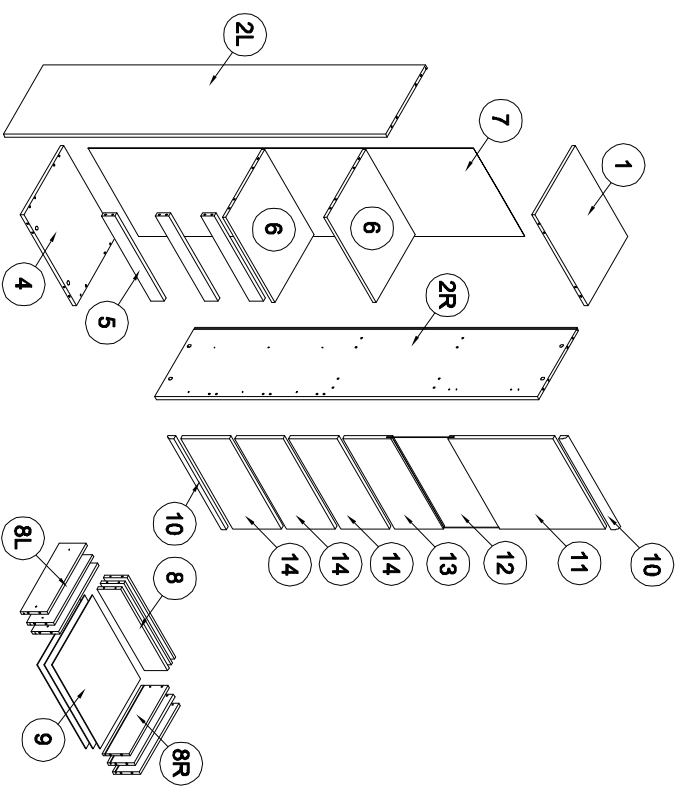

<b>Y</b> x4 8x32	<b>N</b> x23 3x20	<b>X</b> x16 PPW	<b>C</b> x20 ND 3.5x18	<b>Z</b> x20 RC	<b>TB</b> x1 6.3x13	<b>TA</b> x1 PC	<b>V</b> x18 3x13
<b>A</b> x44	<b>B</b> x20	<b>PPW</b> x6	<b>ND</b> x19	<b>RC</b> x3	<b>H</b> x6	<b>PC</b> x3	<b>GLUE</b> x1

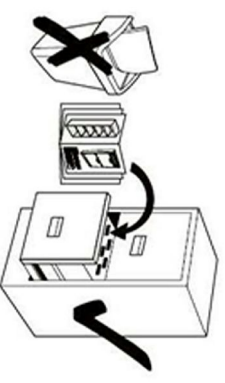
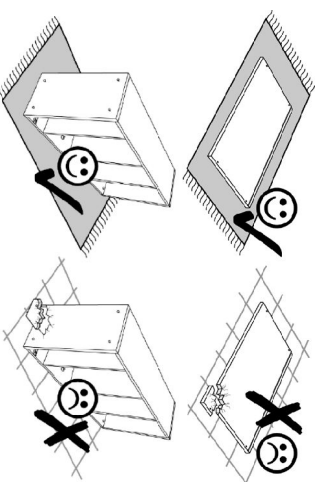

2

3

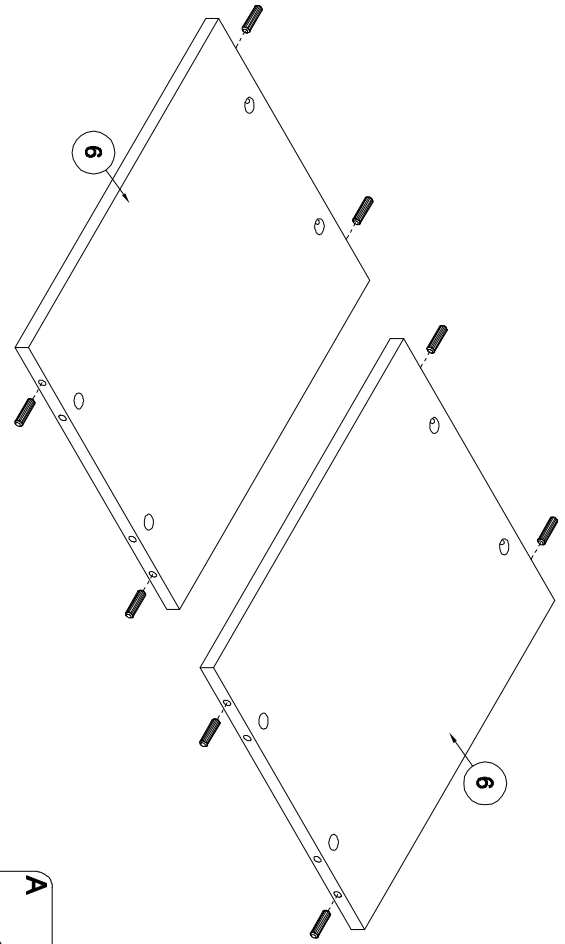

- A** 8x32 X8

4

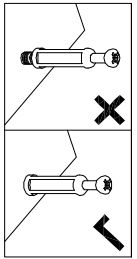

- A** 8x32 X4
- B** 8x32 X12

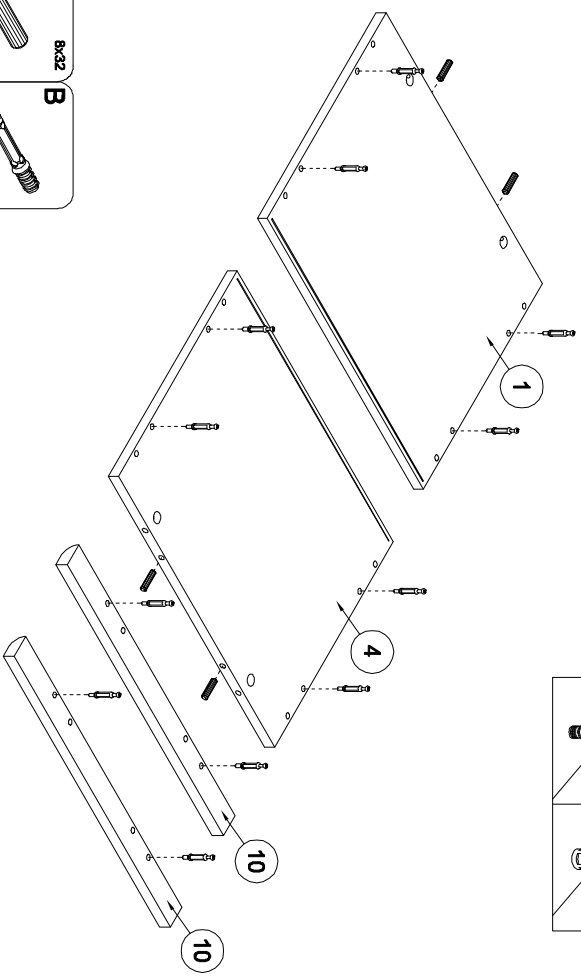

5

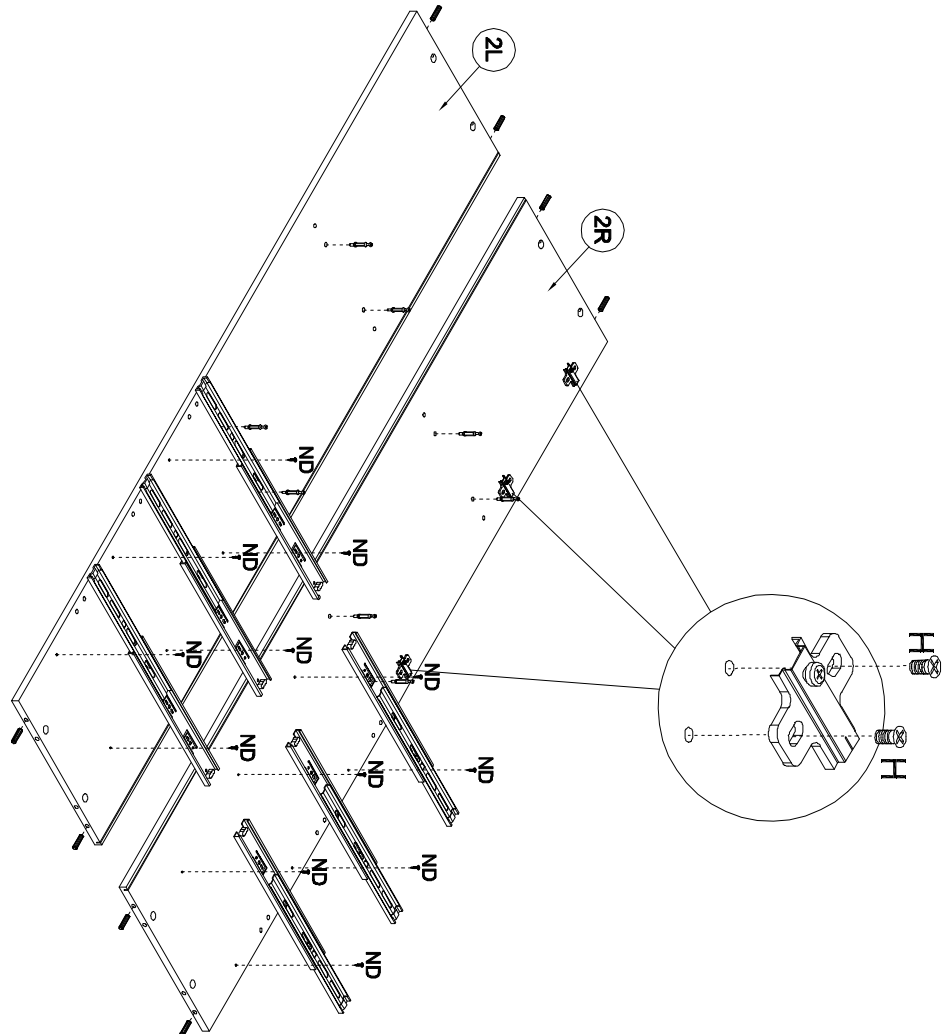
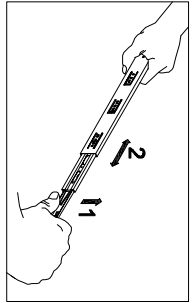

- PPW** X6
- ND** 3.5x16 X12
- A** 8x32 X8
- RC** X3
- H** 6.3x13 X6
- B** 8x32 X8

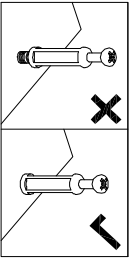

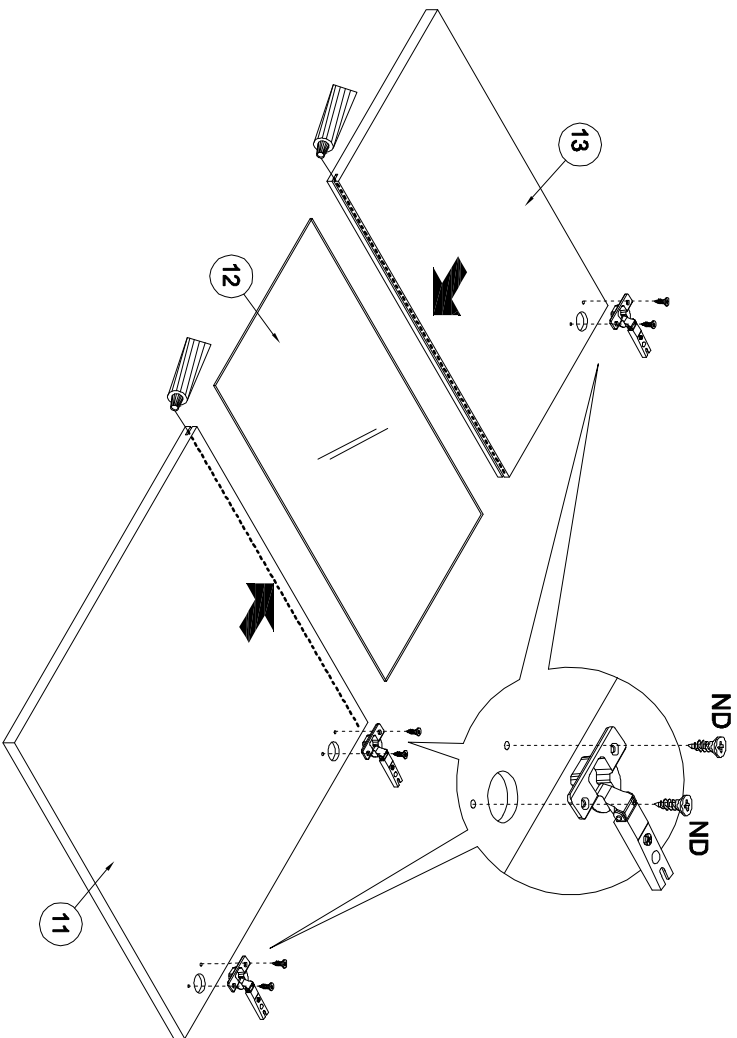

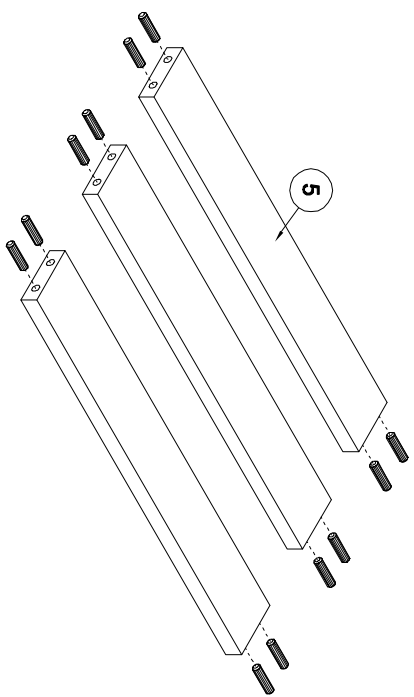
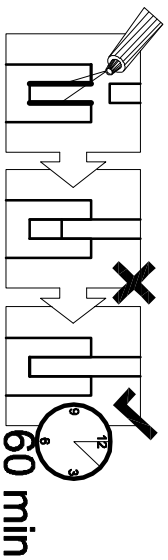

- PC  x3
- ND  3.5x16 x6
- GLUE  x1

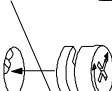
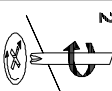

- 1 
- 2 

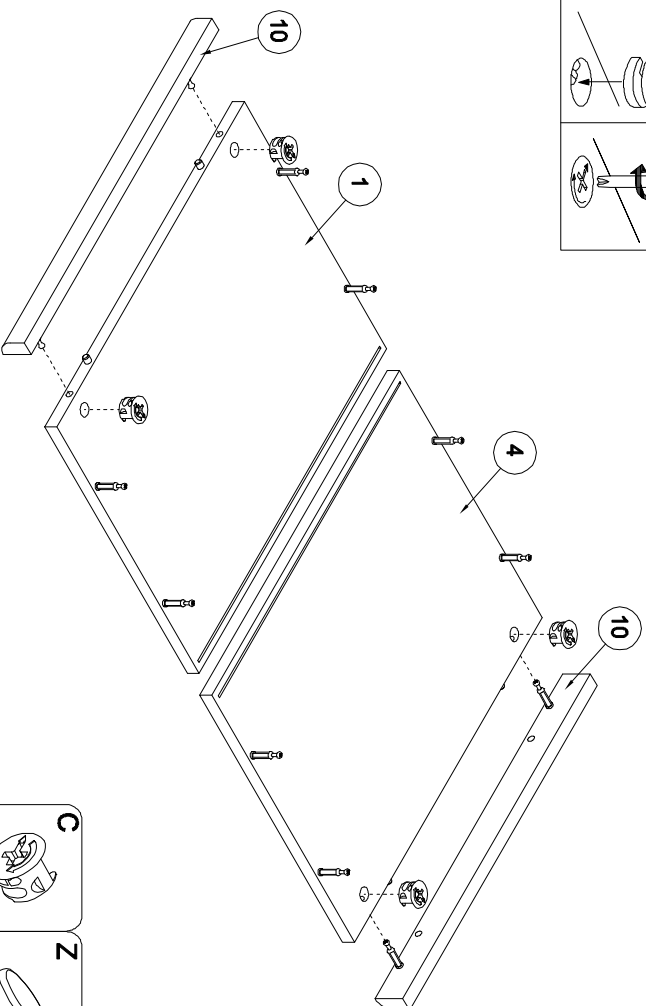
- A  8x32 x12



- C  x4
- Z  x4

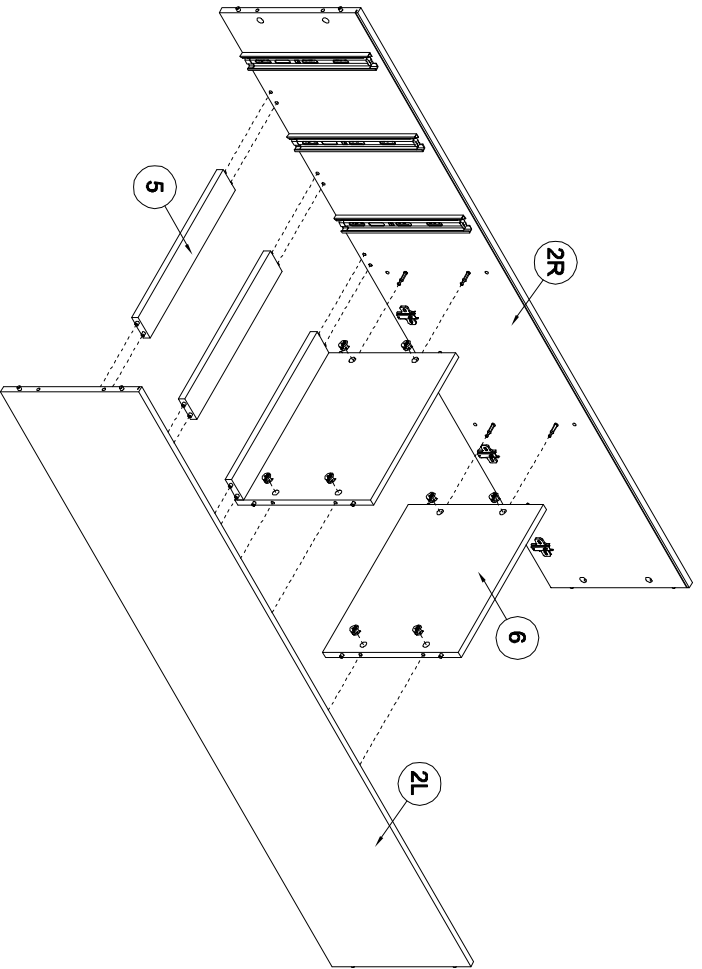
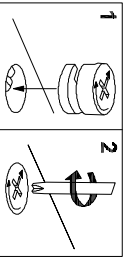

9

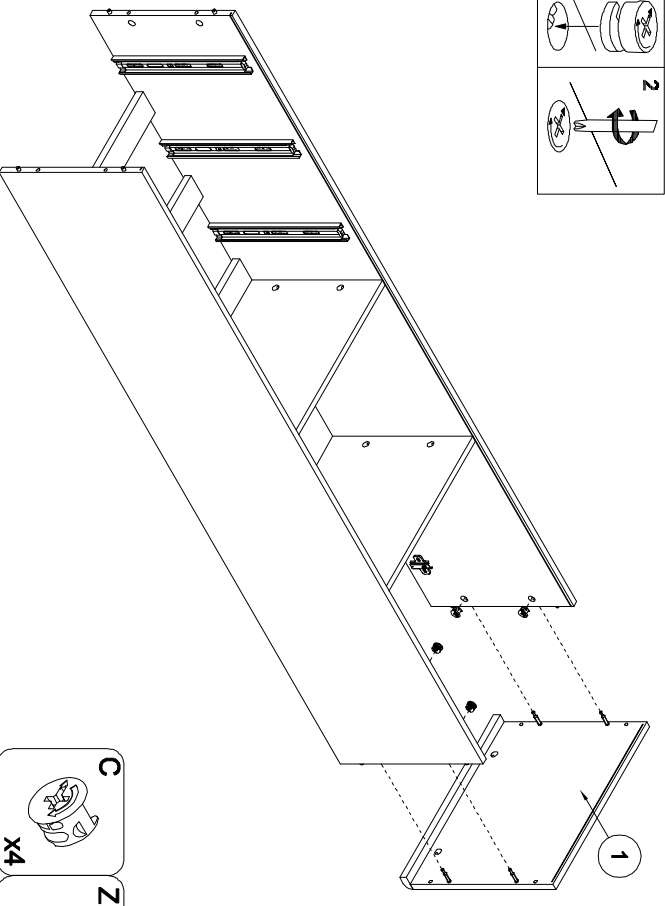
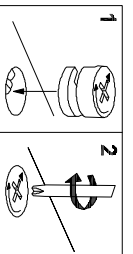

10

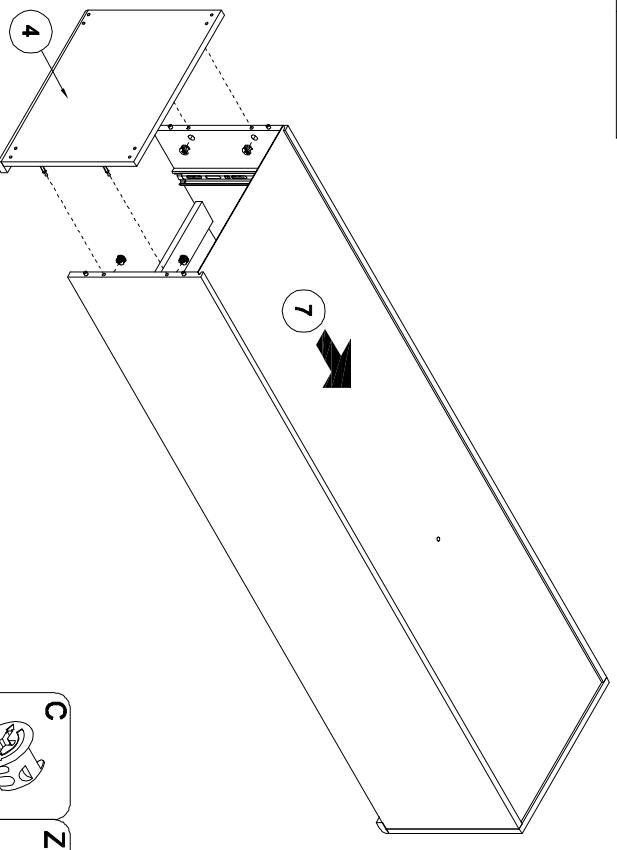
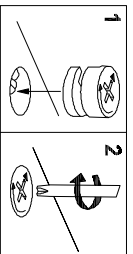
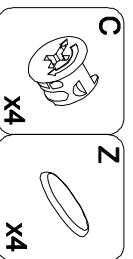

11

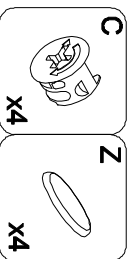

12

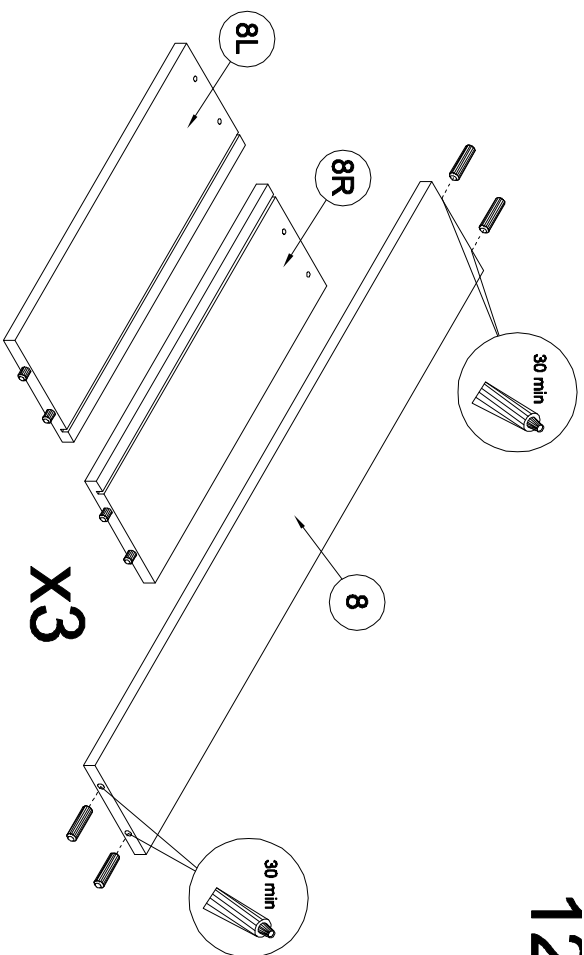

14

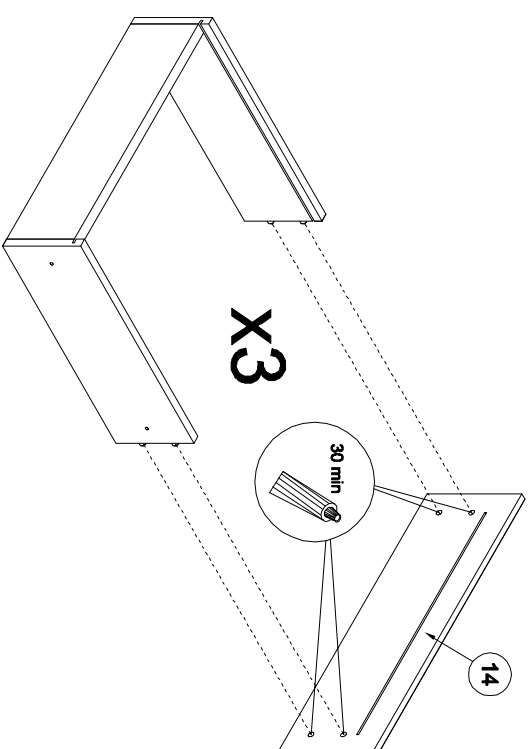

13

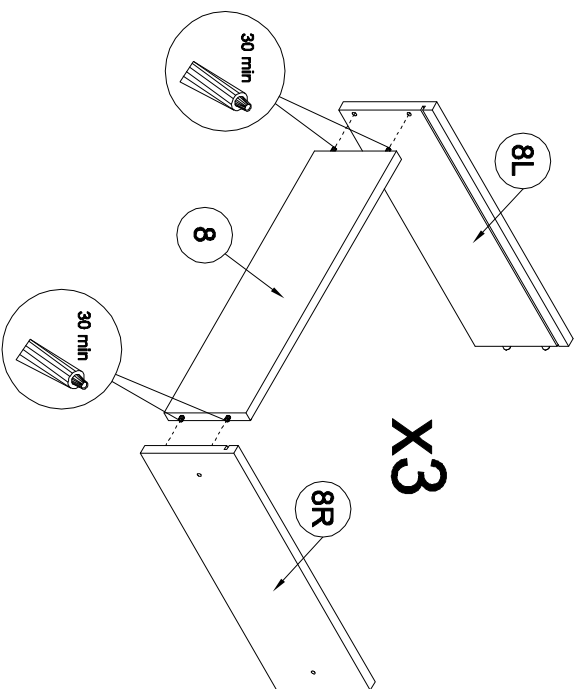

15

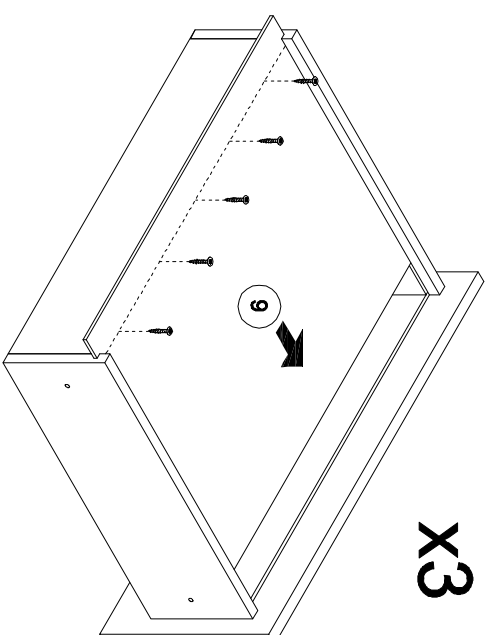

N  
3x20  
x15

GLUE  
x1

