

# MARKUS

## MWT 90

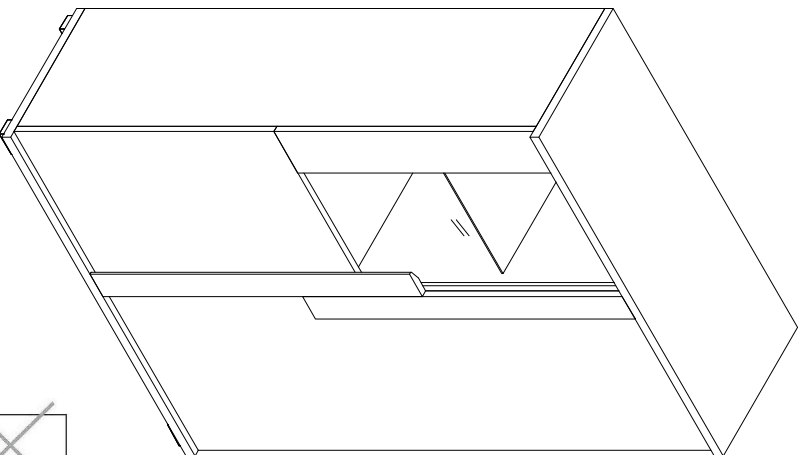

22.03.2016

- (D) Montageanleitung
- (FR) Notice de montage
- (NL) Handleiding voor de montage
- (CZ) Montážní návod
- (HU) Szerelési útmutató
- (TR) Montaj talimatı
- (GB) Assembly Instructions
- (IT) Istruzioni di montaggio
- (PL) Instrukcja montażu
- (SK) Návod na montáž
- (RO) Instrucțiunile de montaj
- (RU) Инструкции по монтажу

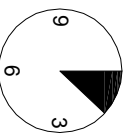

1-1,5

1

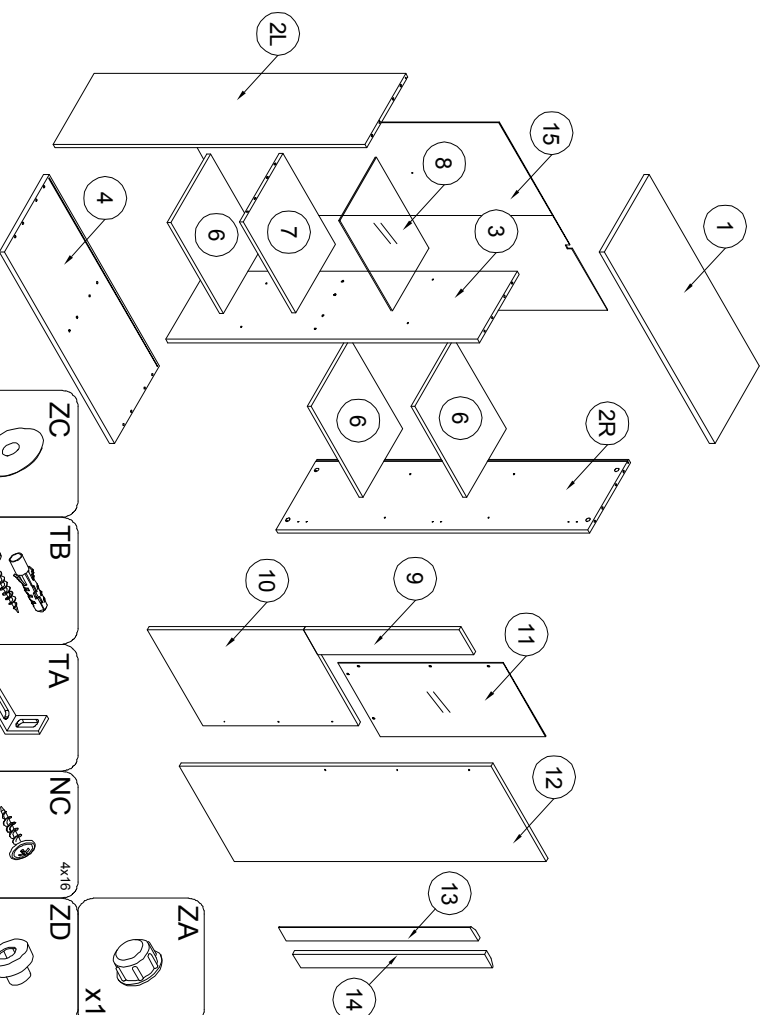

NF 4x30 x6	NA 4x13 x13	P 6x32 x6	ZC x9	GLUE	TB x1	TA x1	NC 4x16 x5	ZD x5	ZA x1
Z x12	ZE x4	A x16	B x16	AB 6x38 x2	X x10	H 6.3x13 x12	N 3x20 x12	Y x5	Z x16

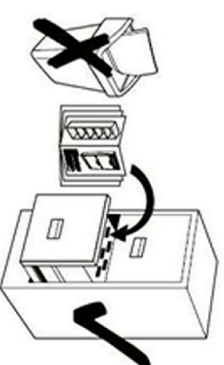
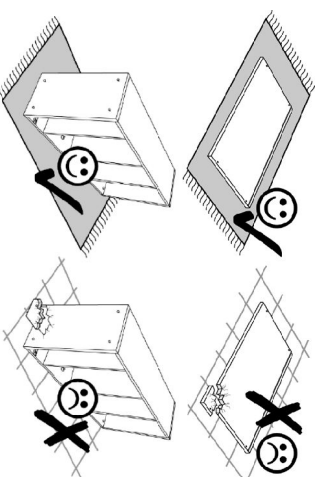

2

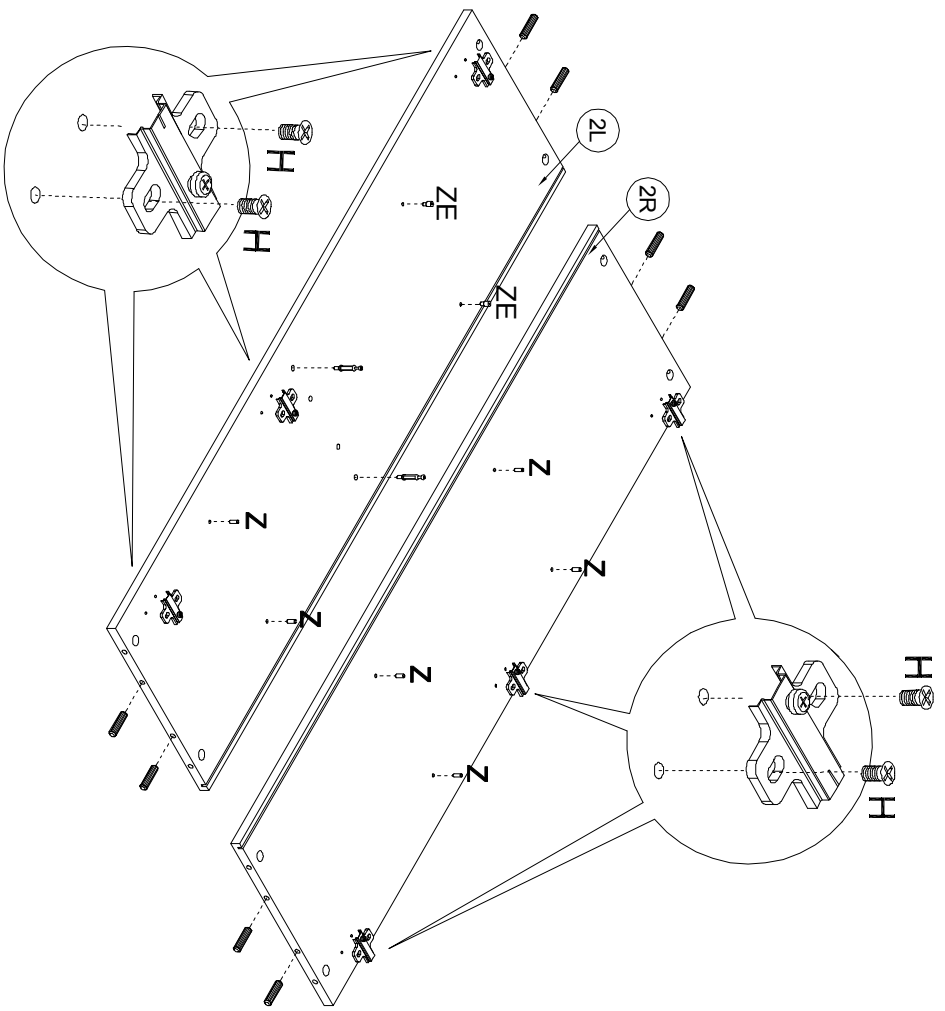
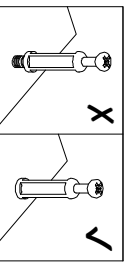

- Z x6
- ZE x2
- A 8x32 x8
- B x2
- R x6
- H 6.3x13 x12

3

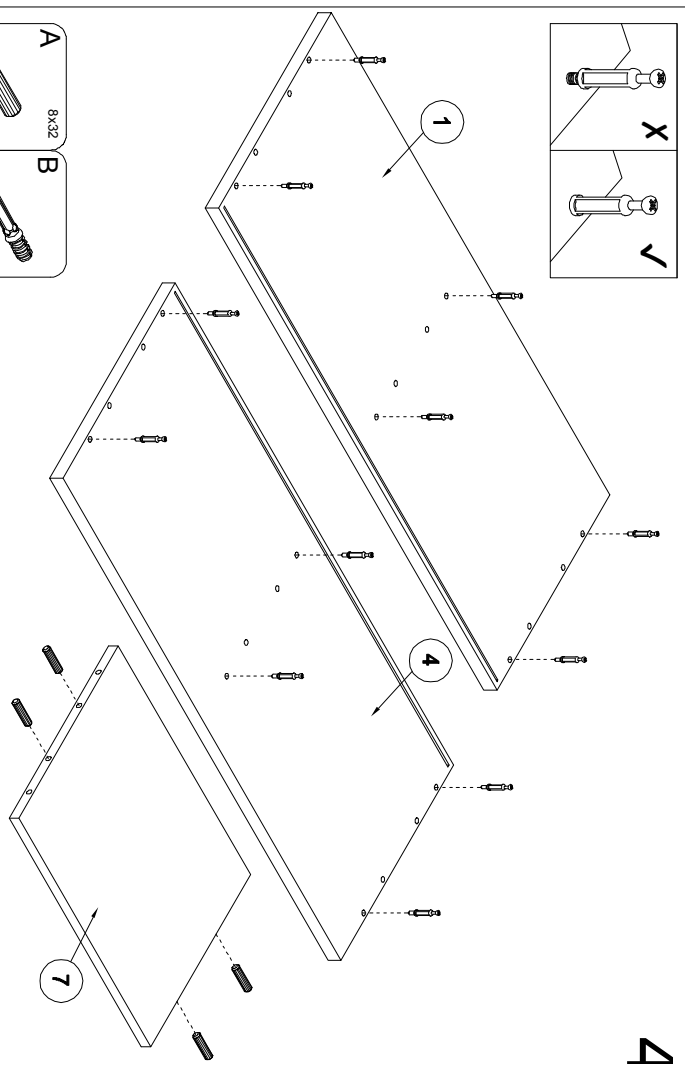
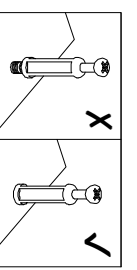

- A 8x32 x4
- B x12

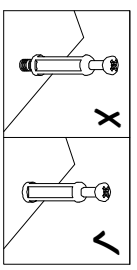

4

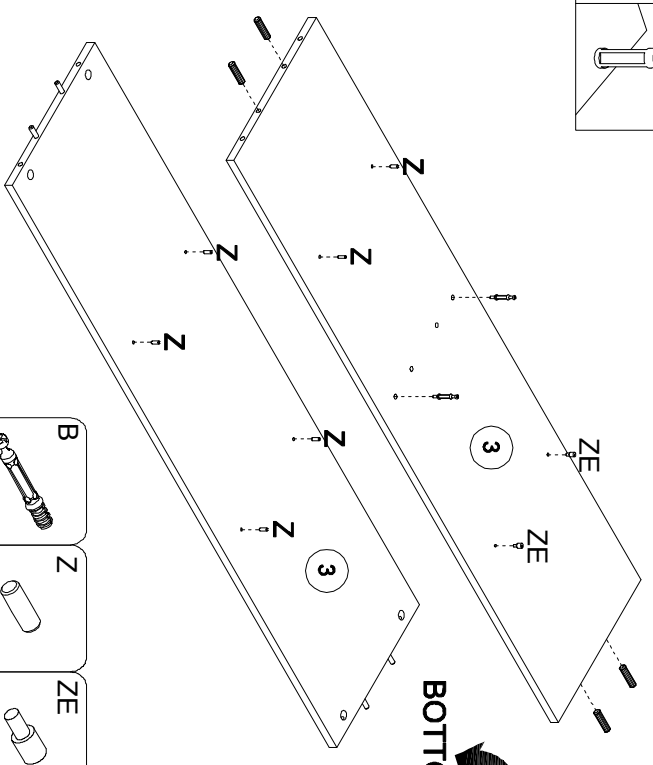

- B x2
- Z x6
- ZE x2
- A 8x32 x4

5

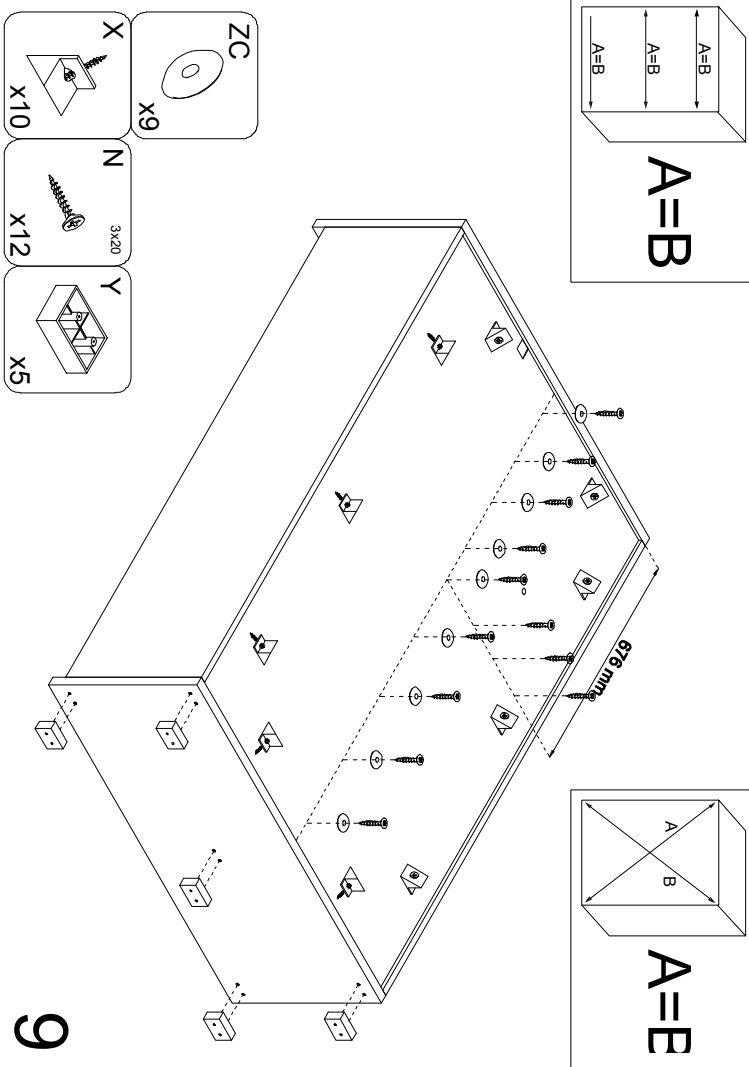
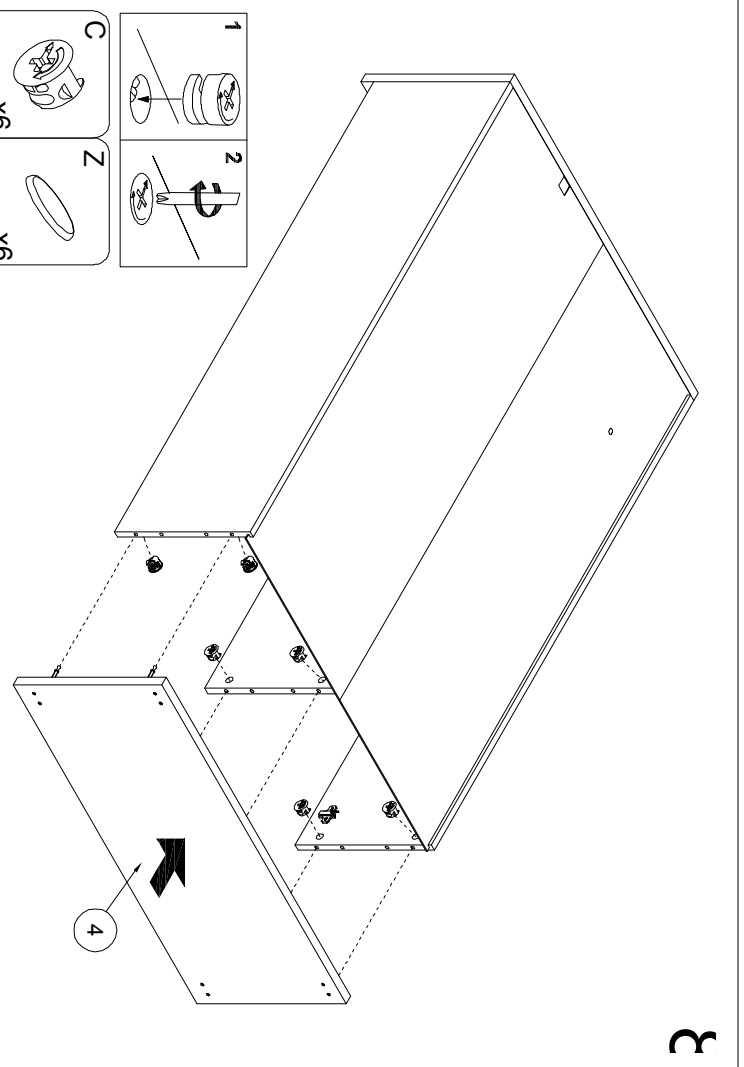
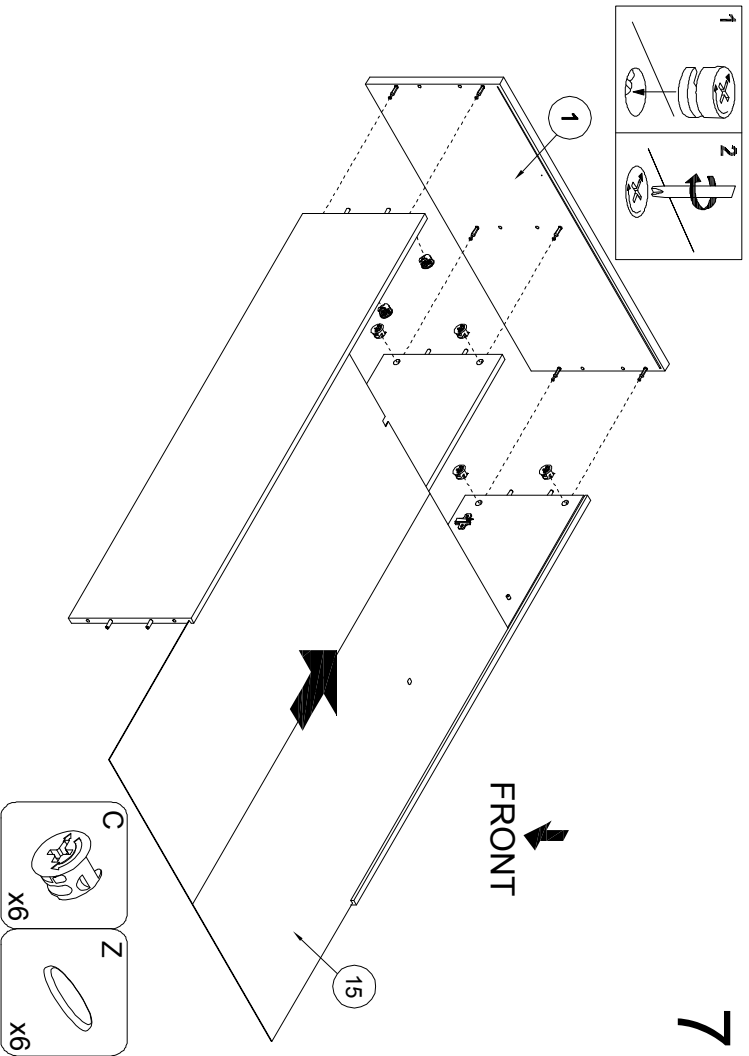
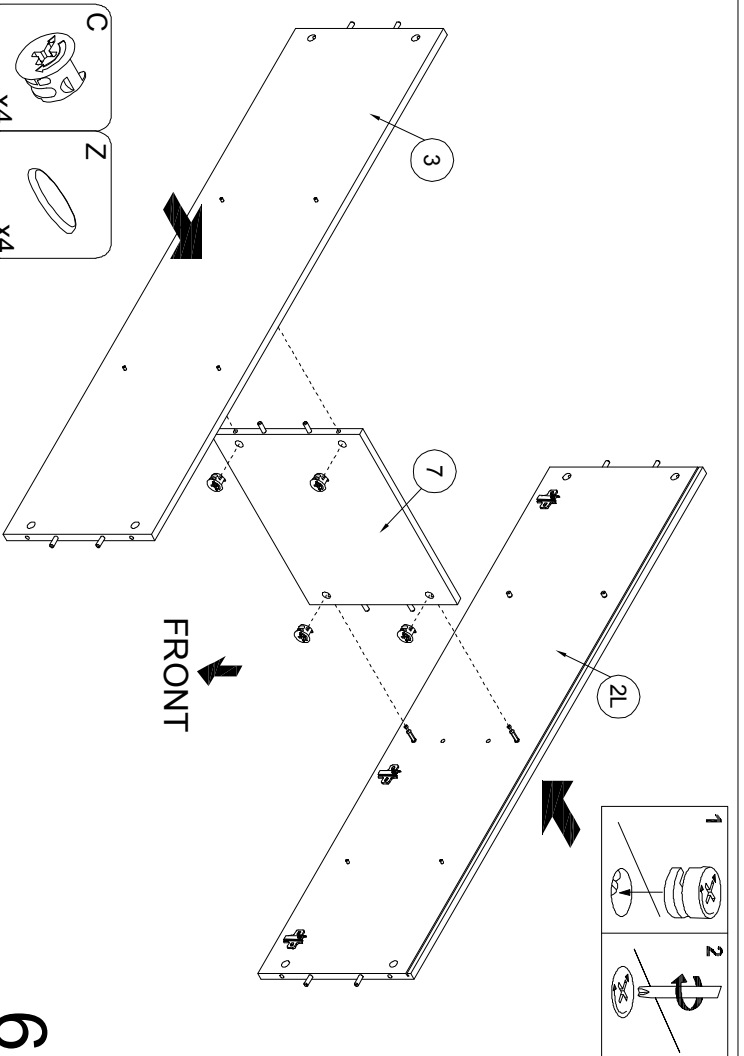

10

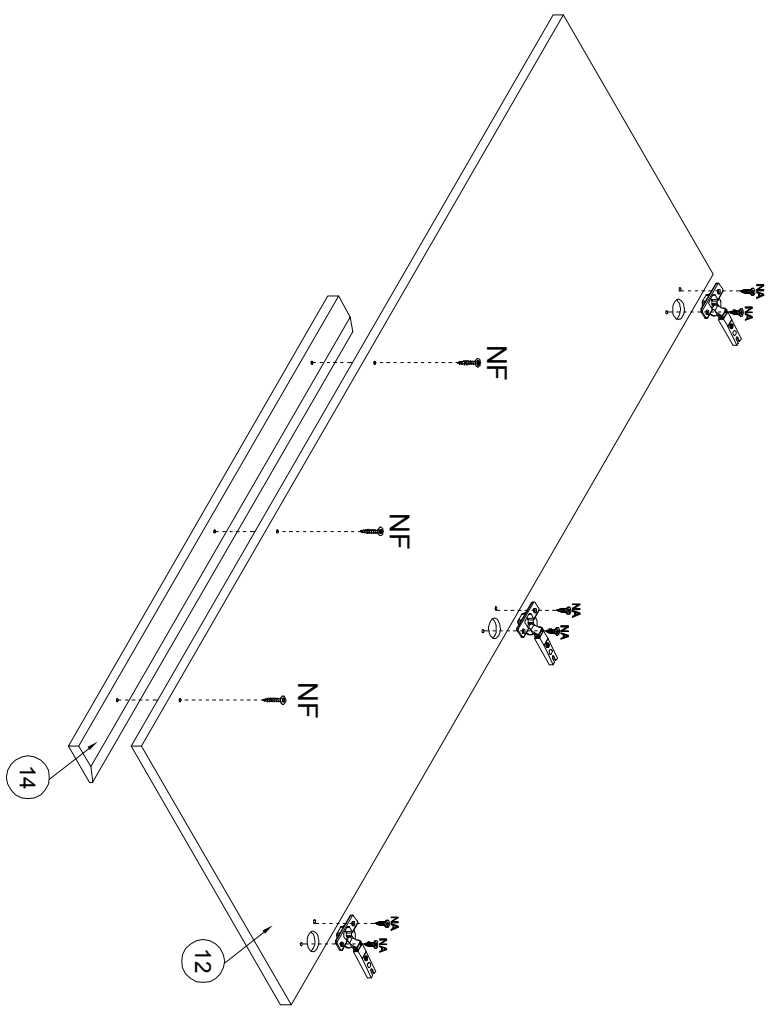

- NF 4x30 X3
- NA 4x13 X6
- P X3

11

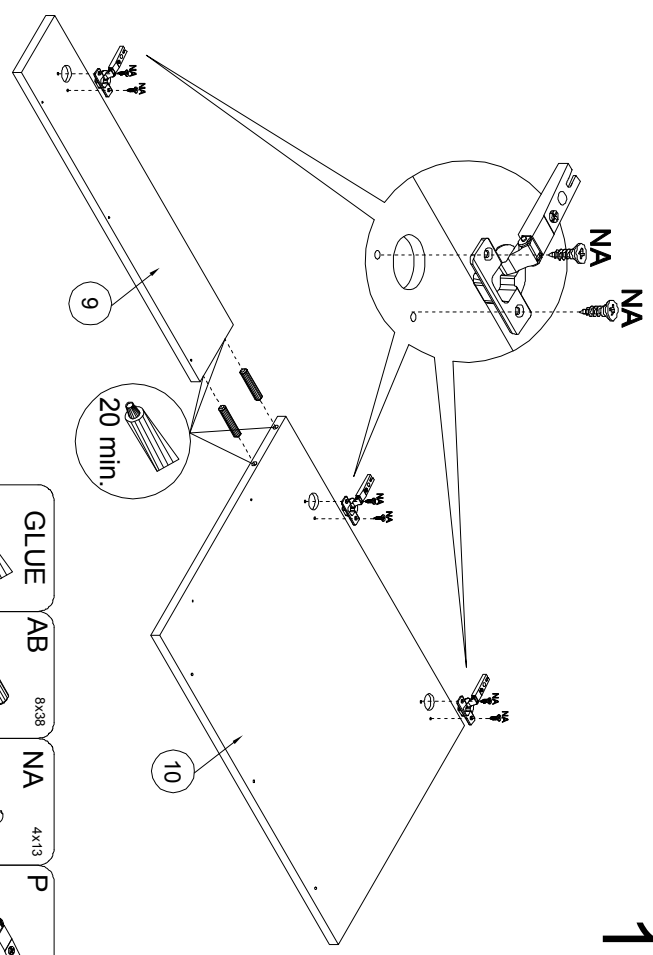

- GLUE X1
- AB 8x38 X2
- NA 4x13 X6
- P X3

12

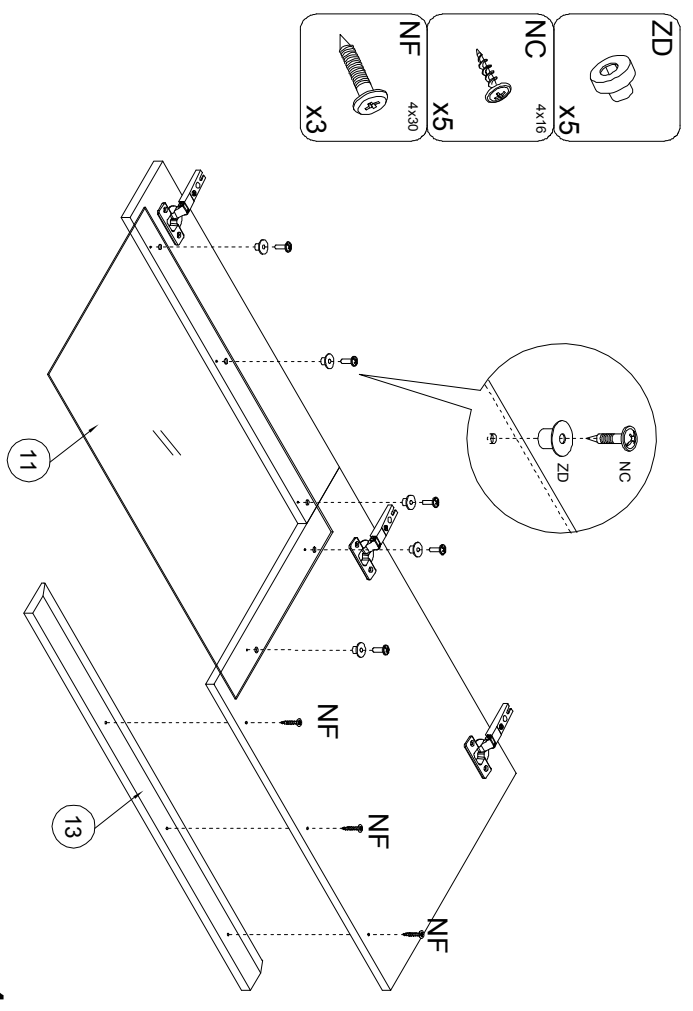

- ZD X5
- NC 4x16 X5
- NF 4x30 X3

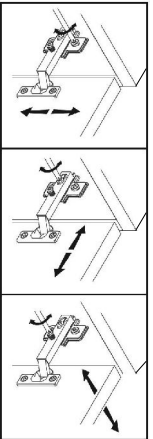
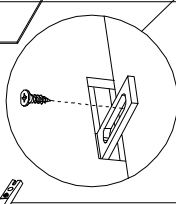
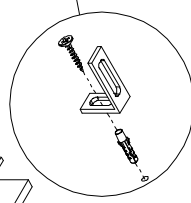
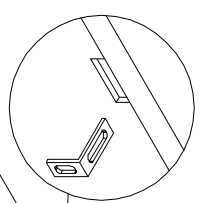
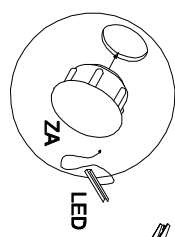
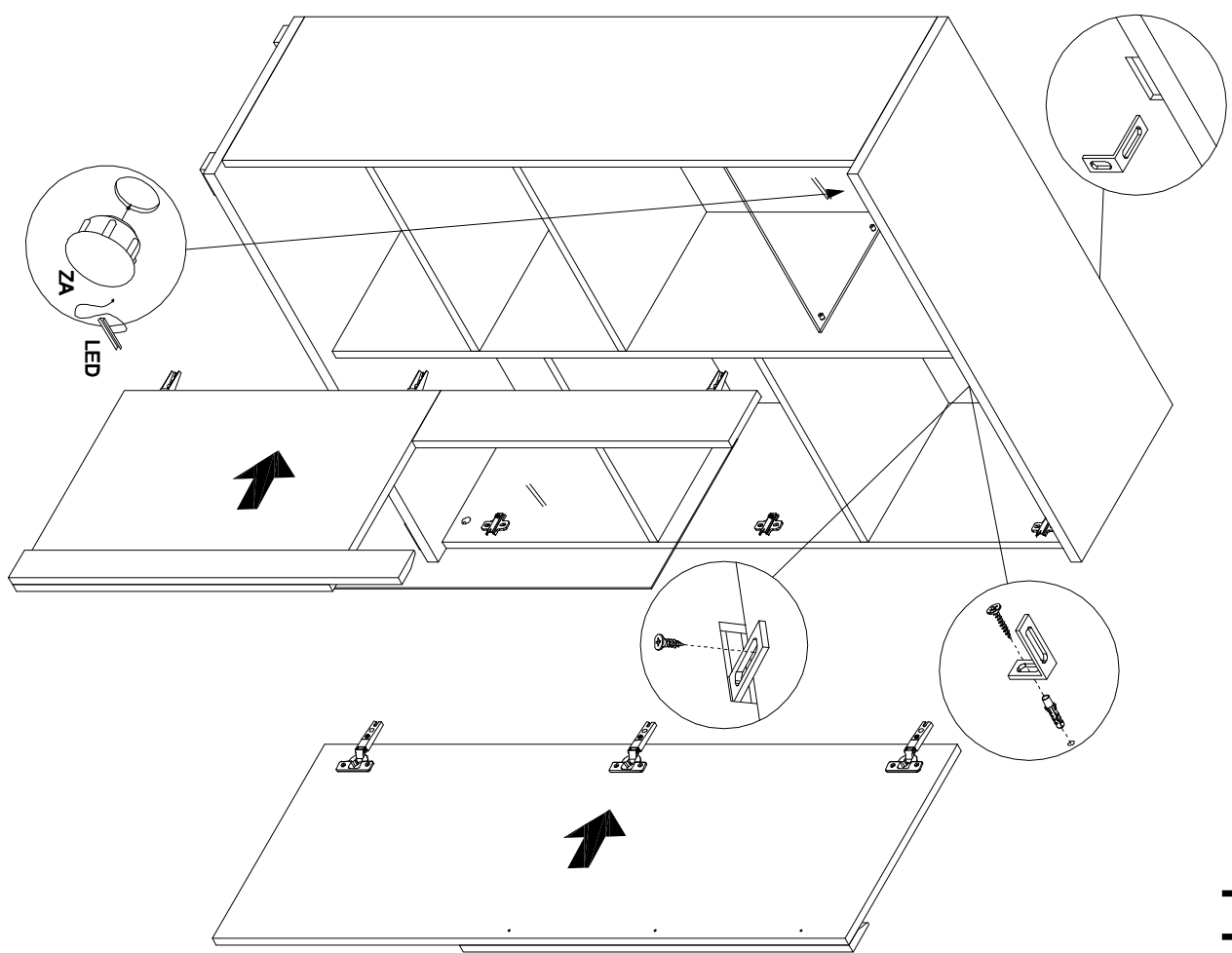
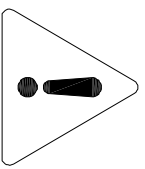
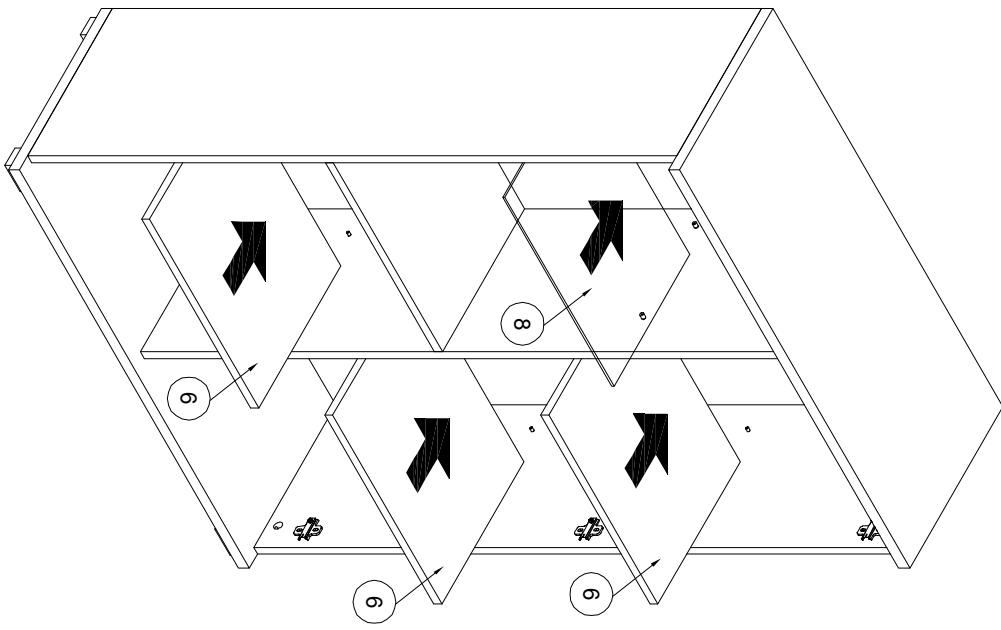

- TB x1
- TA x1
- ZA x1