





NR 1

(B1)  8x28 x29

(M1)  x24

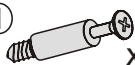
(T1)  x24

(K1)  Ø7x50mm x1

(C2)  x4

(W1)  x8

(J23)  x18+16

(F1)  x12

(S4)  3,0x20 x12

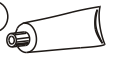
(L1)  x1

NR 2

(F33)  x12

(P13)  3,5x13 x24+48

(F12)  x6

(G5)  x16

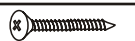
(S4)  3,0x20 x16

(S6)  4,0x30 x6

(F15)  x6

NR 3

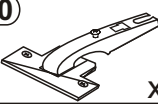
(Y0)  x6

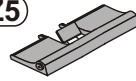
(Z5)  x2

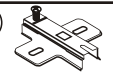
(D7)  x6

(E3)  6,3x13 x12

(S8)  4x13 x12

NR 4

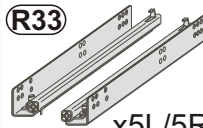
(R33)  x5L/5R

(E24)  6,0x11 x16

(E8)  6,0x8 x4

(P7)  4x30 x20

(T2)  5x35mm x10

(M2)  12x10mm x10

NR 5

(U22)  x7

(A18)  4,0x25 x7

NR 6

(J44)  x1

(P13)  3,5x13 x1

(G22)  8 x2



1

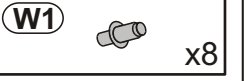
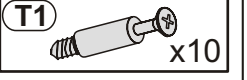
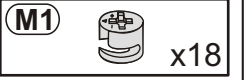
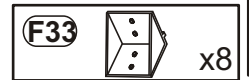
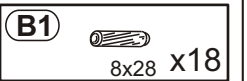
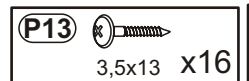
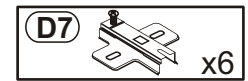
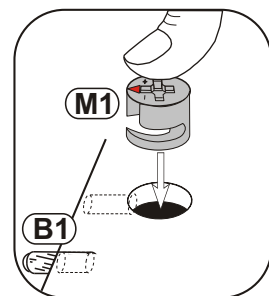
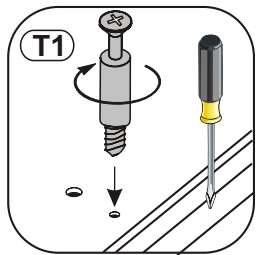
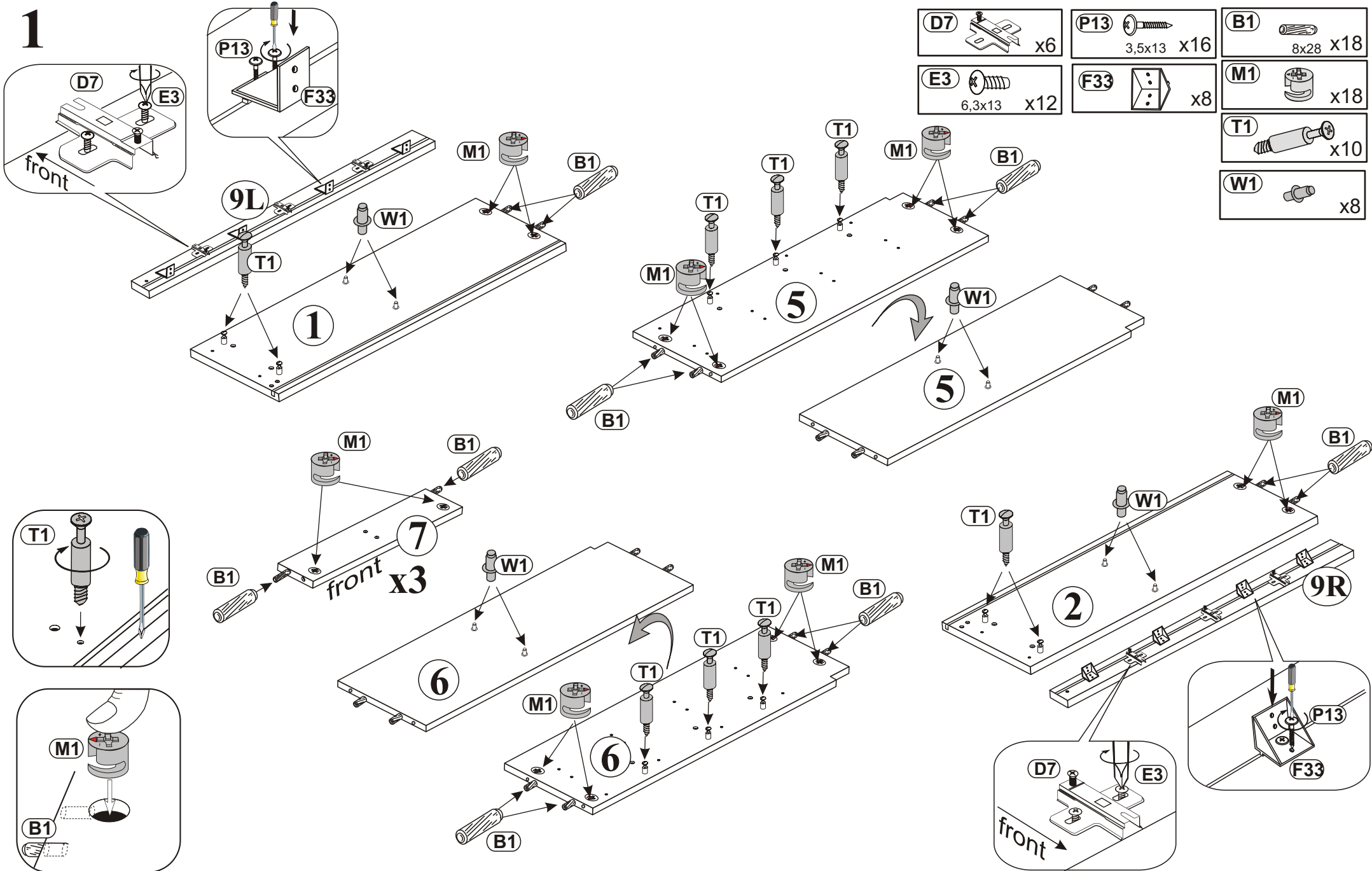

2

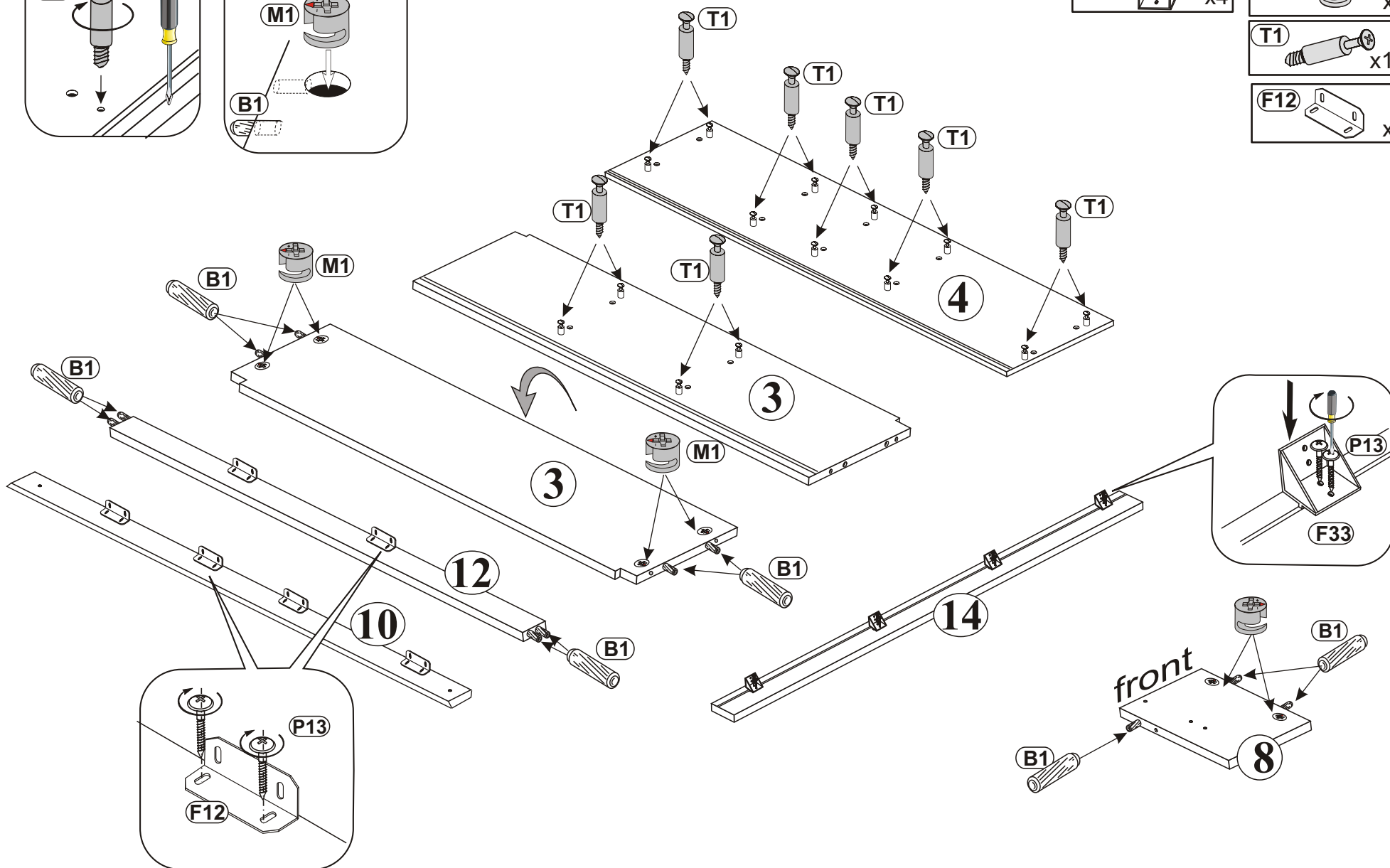
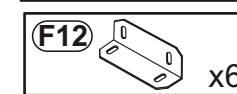
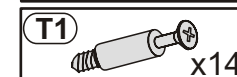
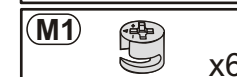
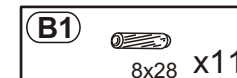
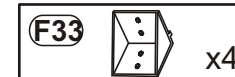
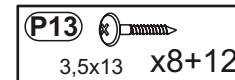
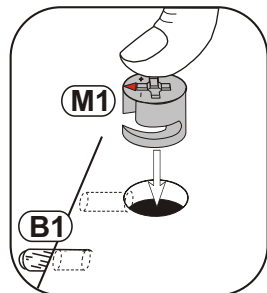
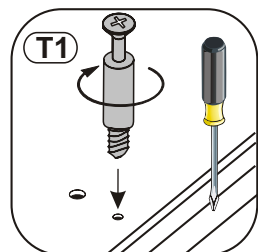

3

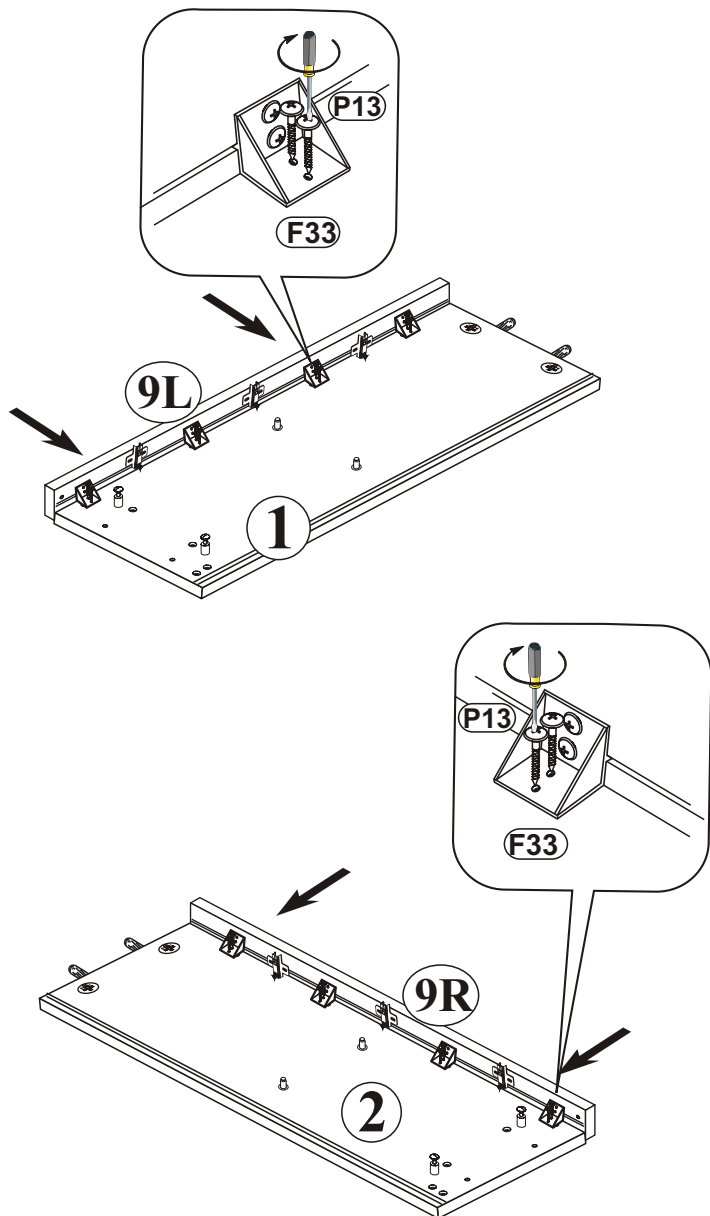
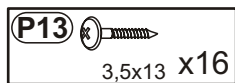

4

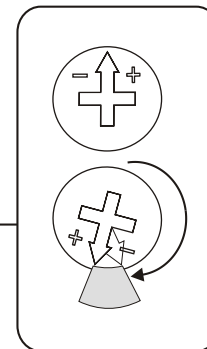
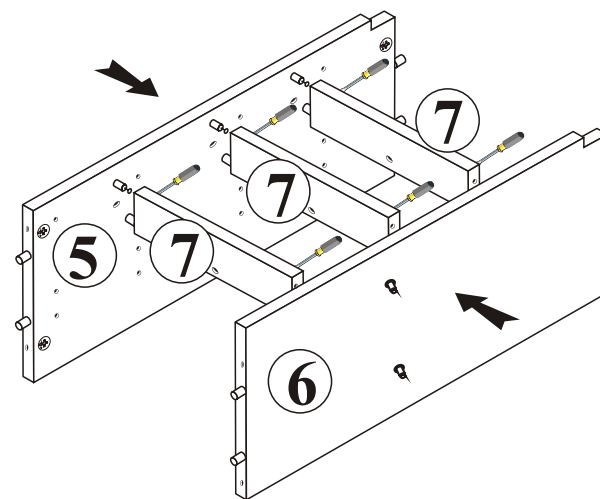

5

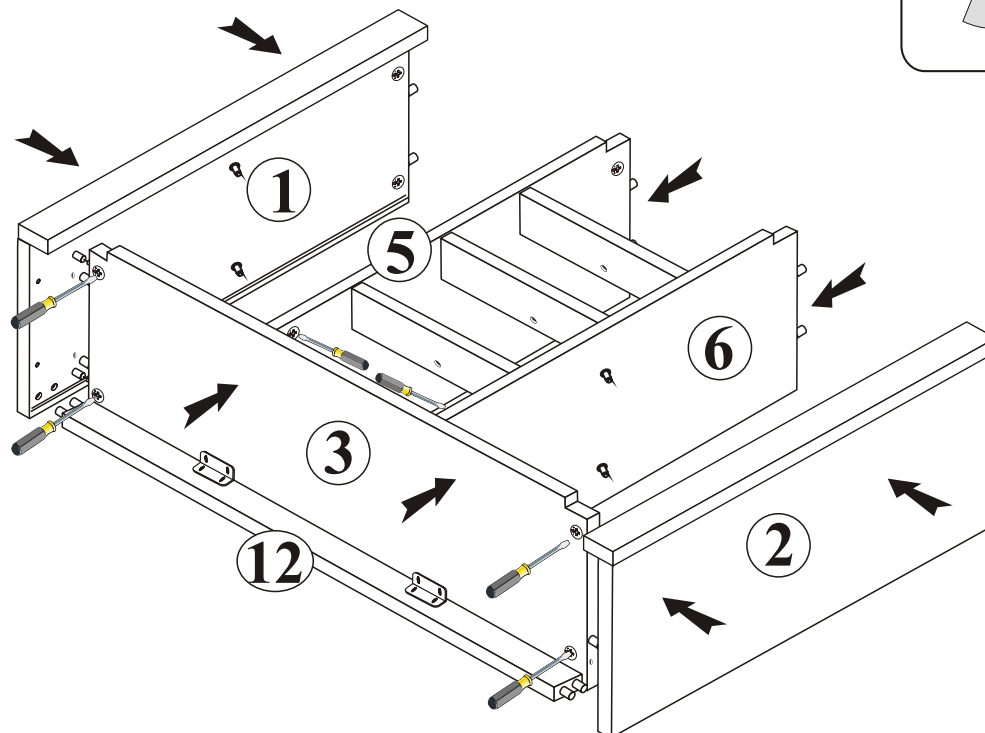

6

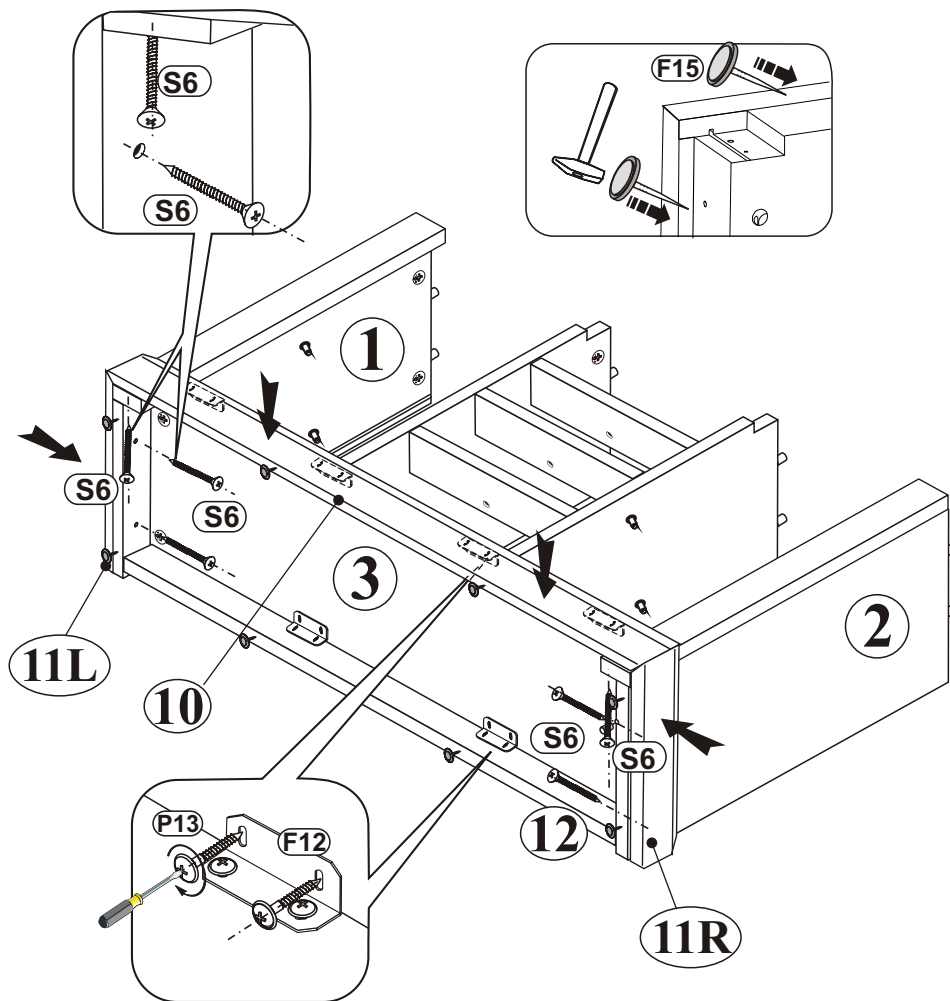
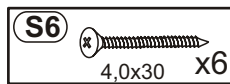
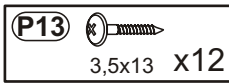
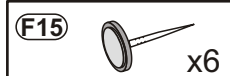

7

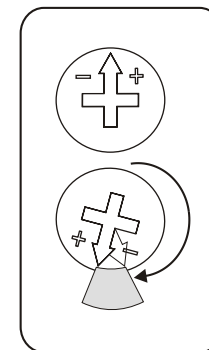
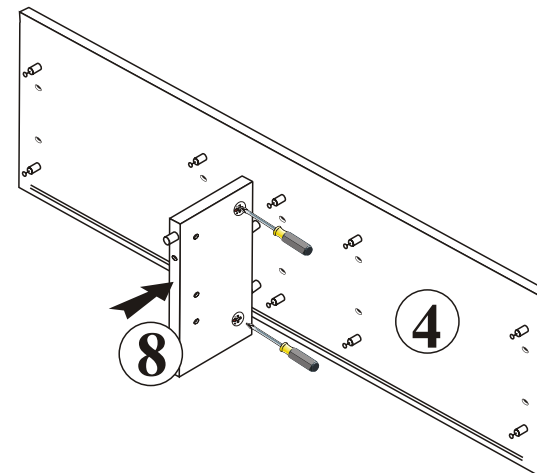

8

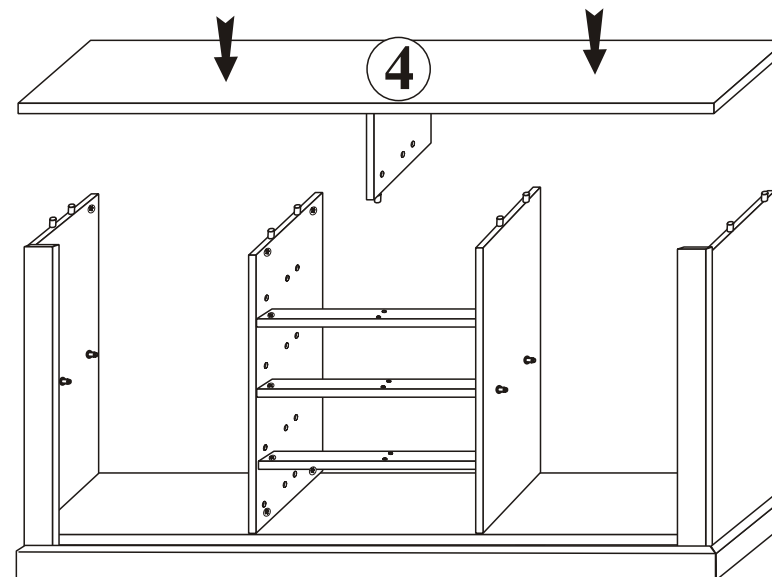

9

P13  3,5x13 X8

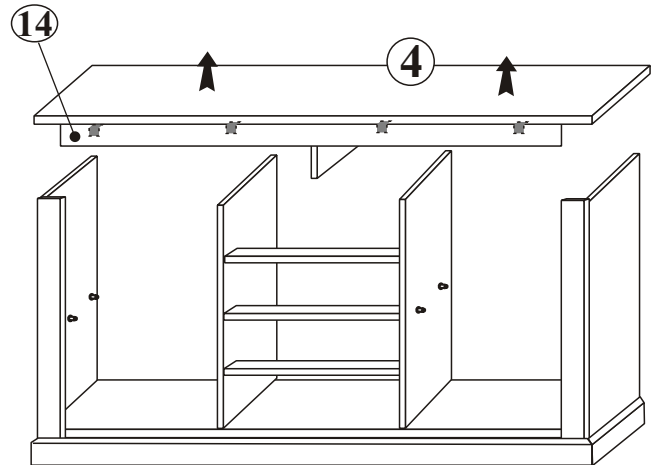
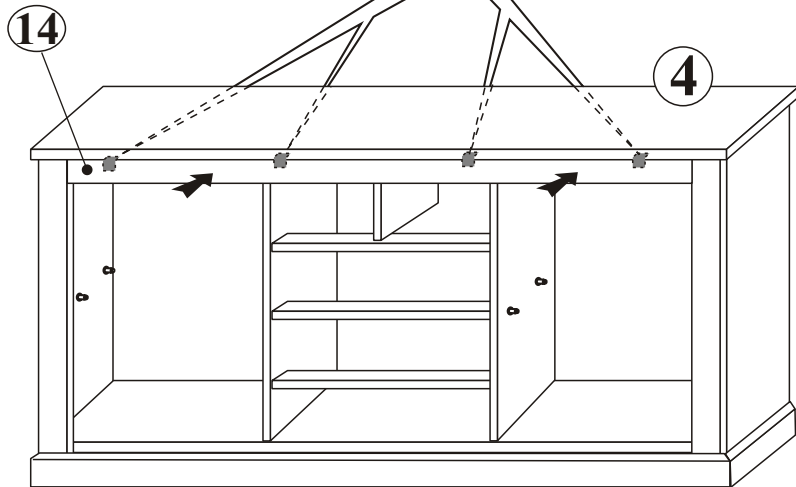
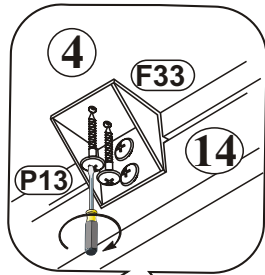

10

K1  Ø7x50mm X1

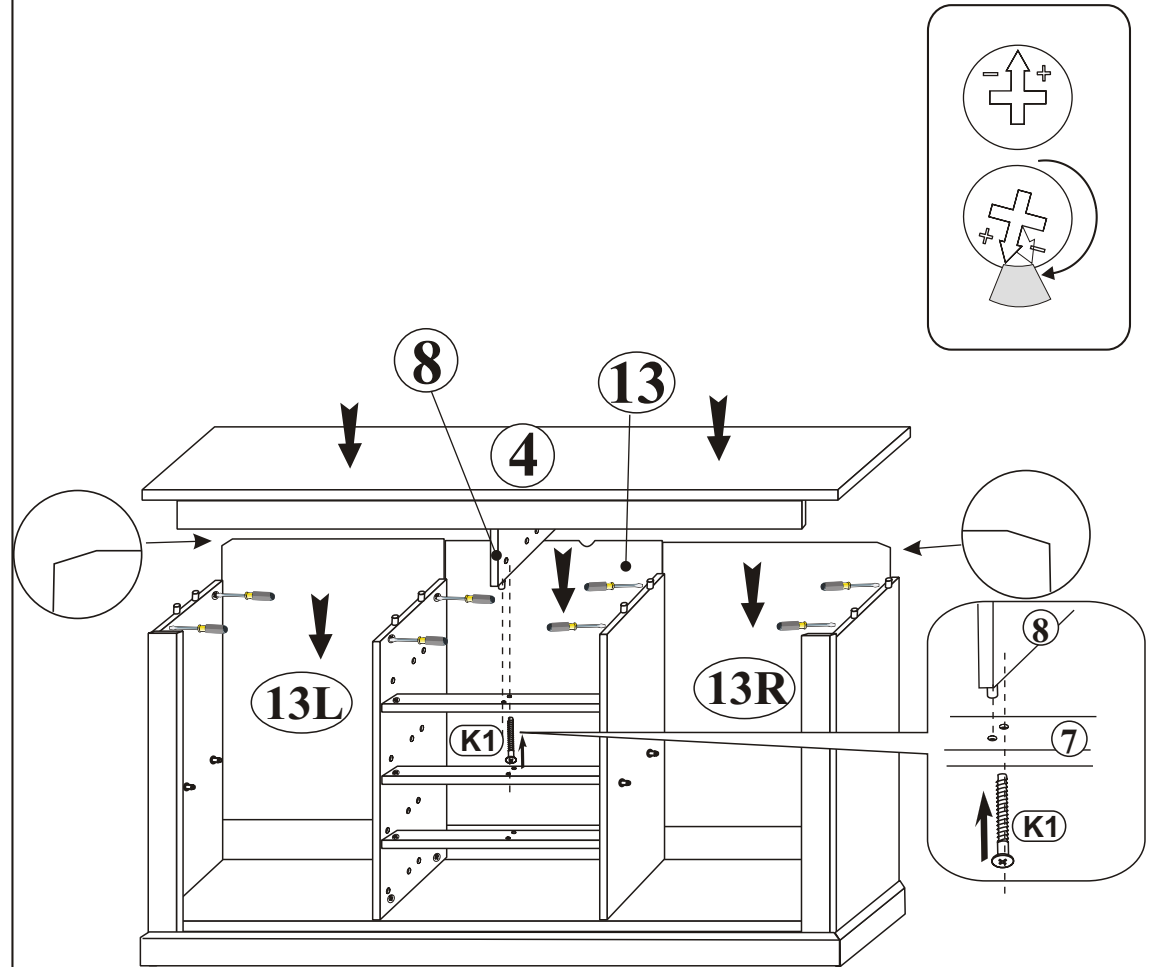

11

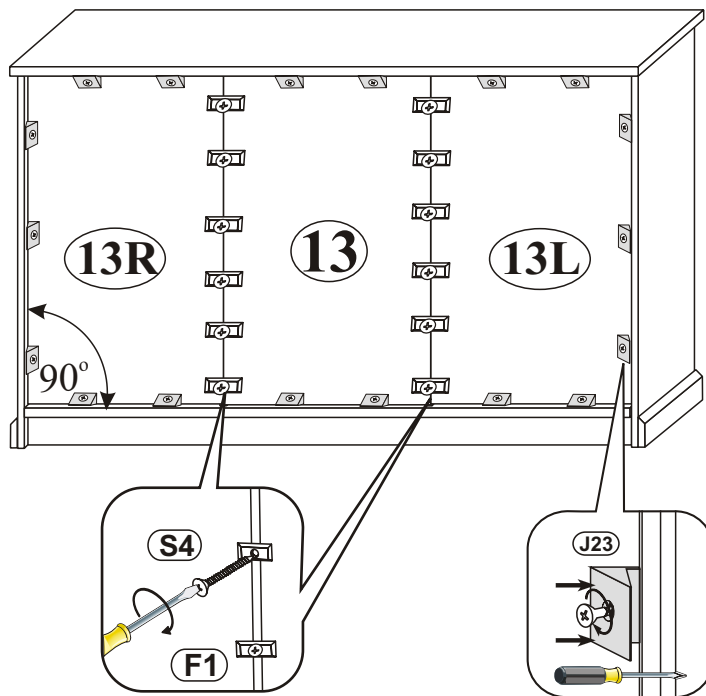
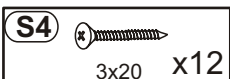

12

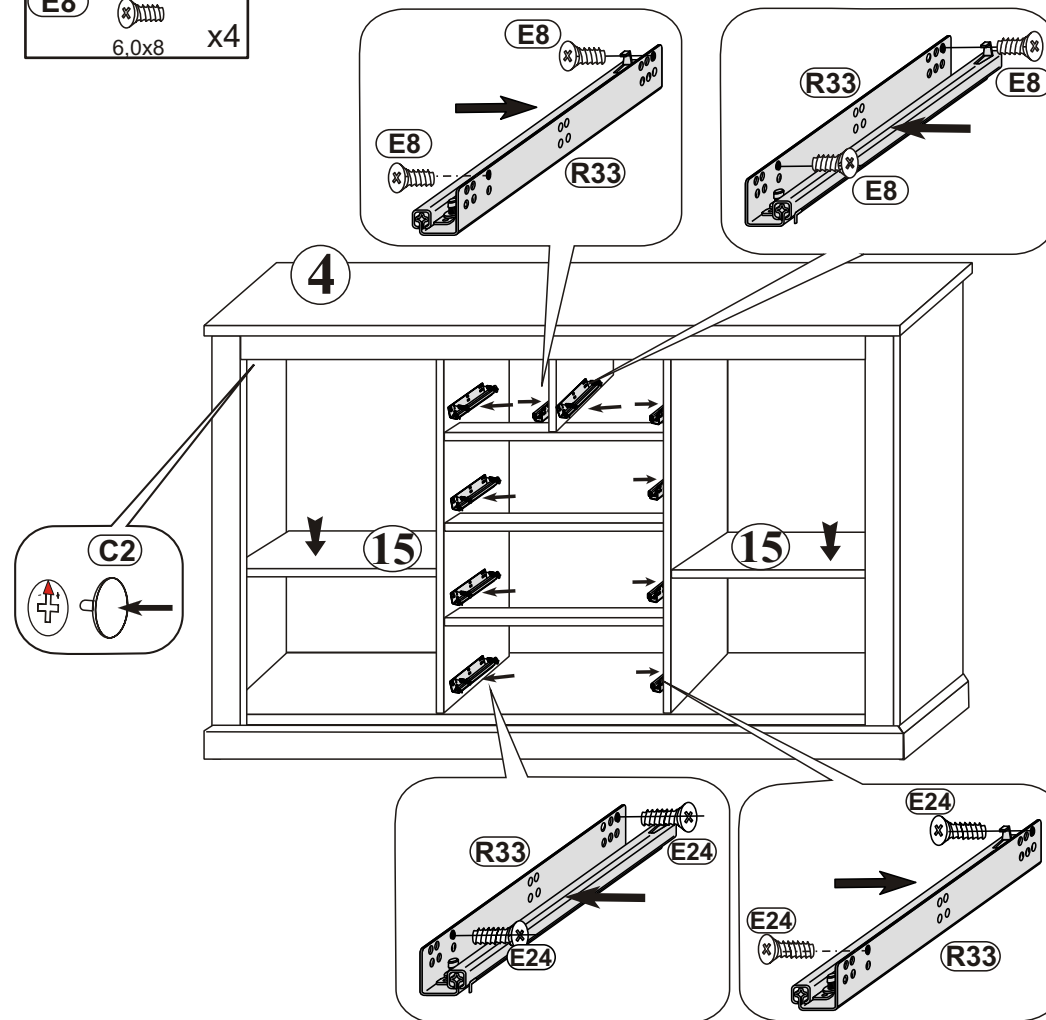
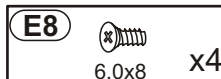
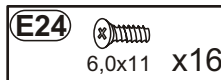
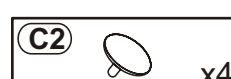
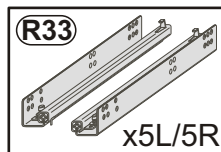

13

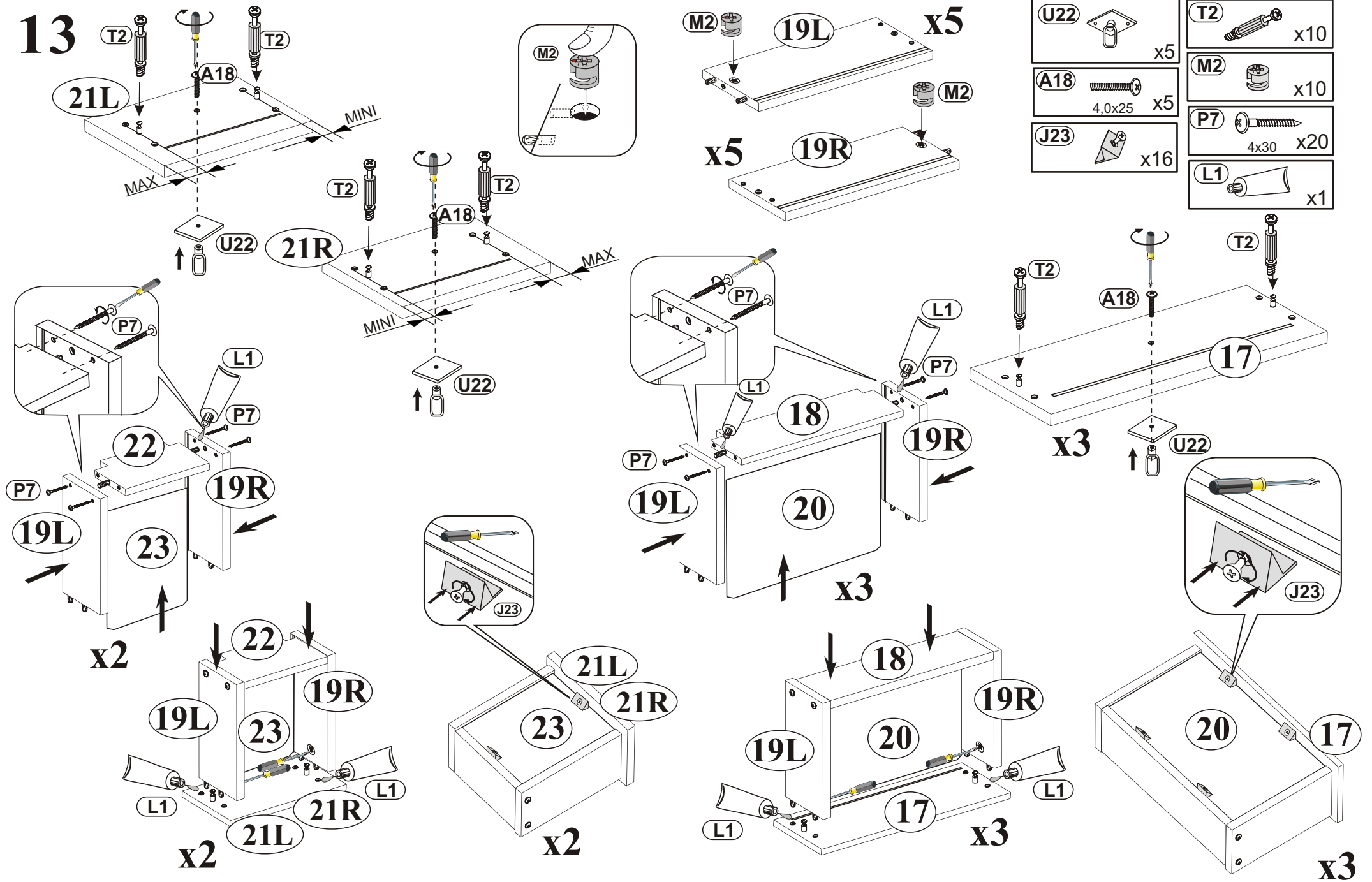

14

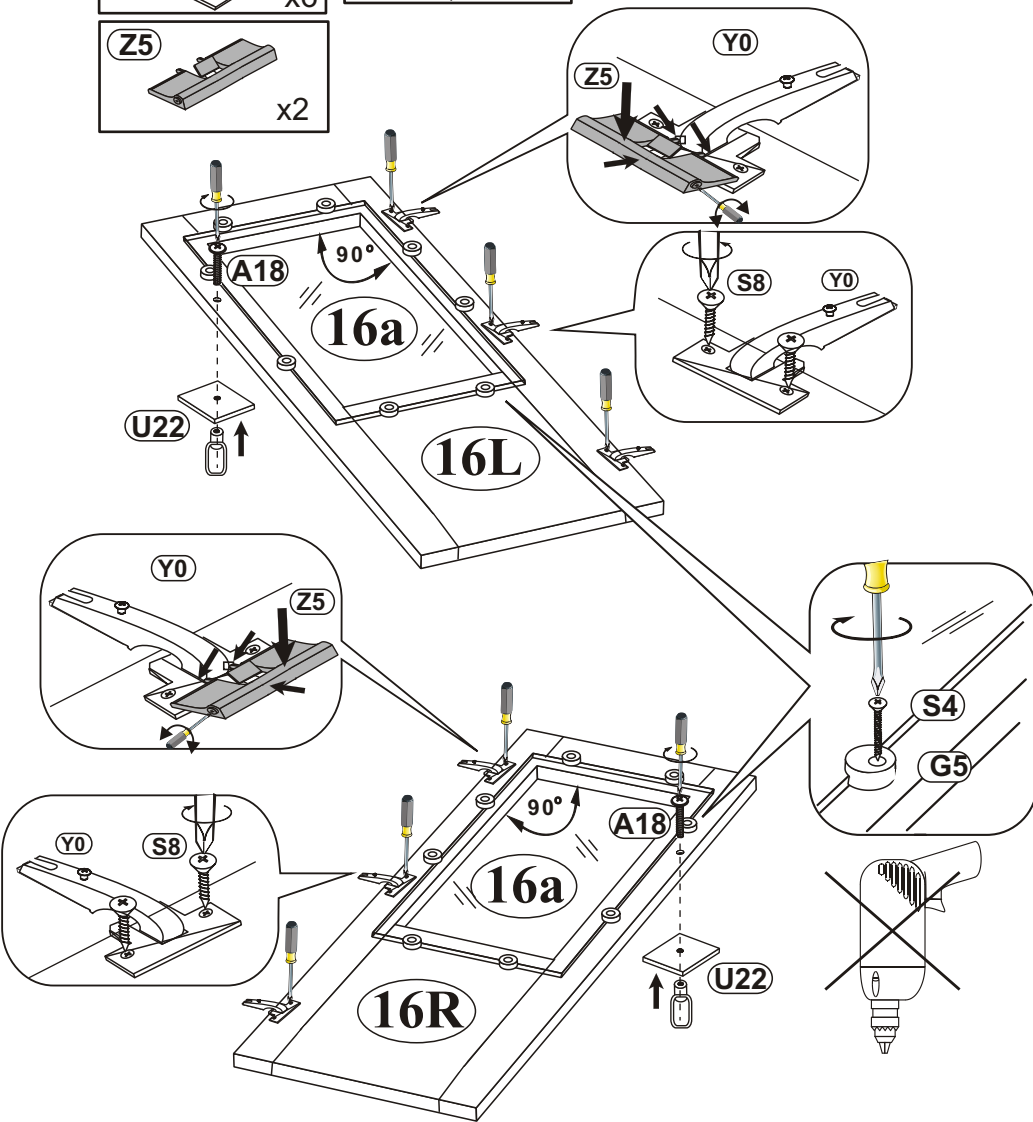
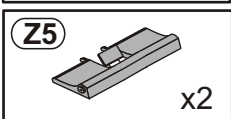
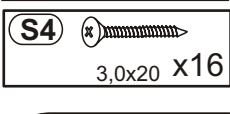
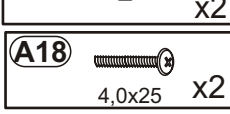
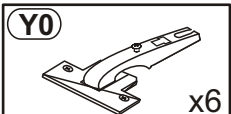
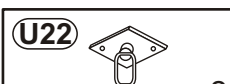
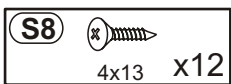

15

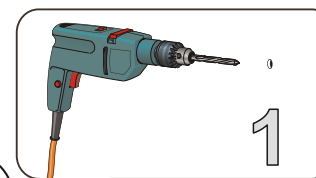

1

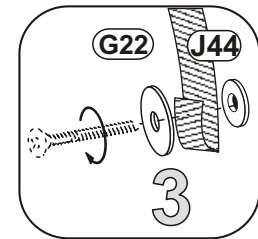

3

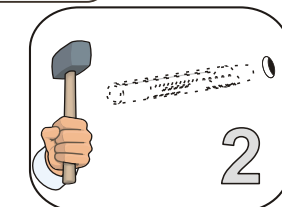

2

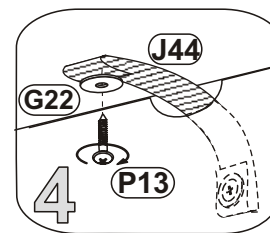

4

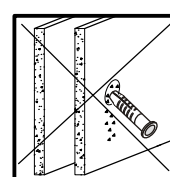
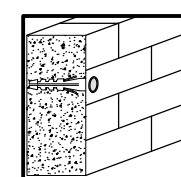
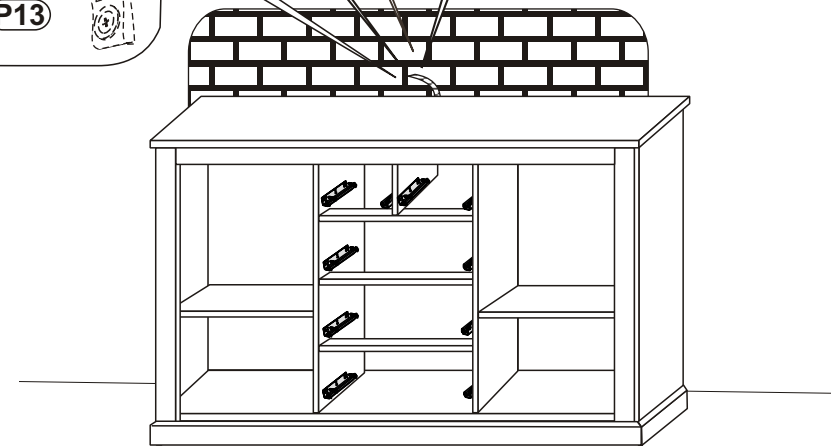
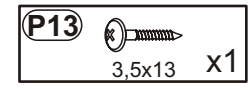
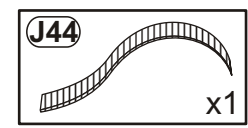

16

