

- NR 1**
- B1** 8x28 x16
 - M1** x16
 - T1** x16
 - C2** x8
 - J23** x20
 - F1** x8
 - S4** 3,0x20 x8
 - W1** x8
 - L1** x1
- NR 5**
- N20** x6
 - S2** 4x30 x12

- NR 2**
- R22** L-350 mm x4L/4R
 - E2** 6,3x11 x24
 - P3** 3x13mm x16
 - S3** 3,5x13 x8

- NR 3**
- Y0** 26 KR0 x4
 - Y5** H2 x4
 - S8** 4x13 mm x8
 - E3** 6,3x13 x8

- NR 4**
- U20** x6
 - P5** 4x25 x12



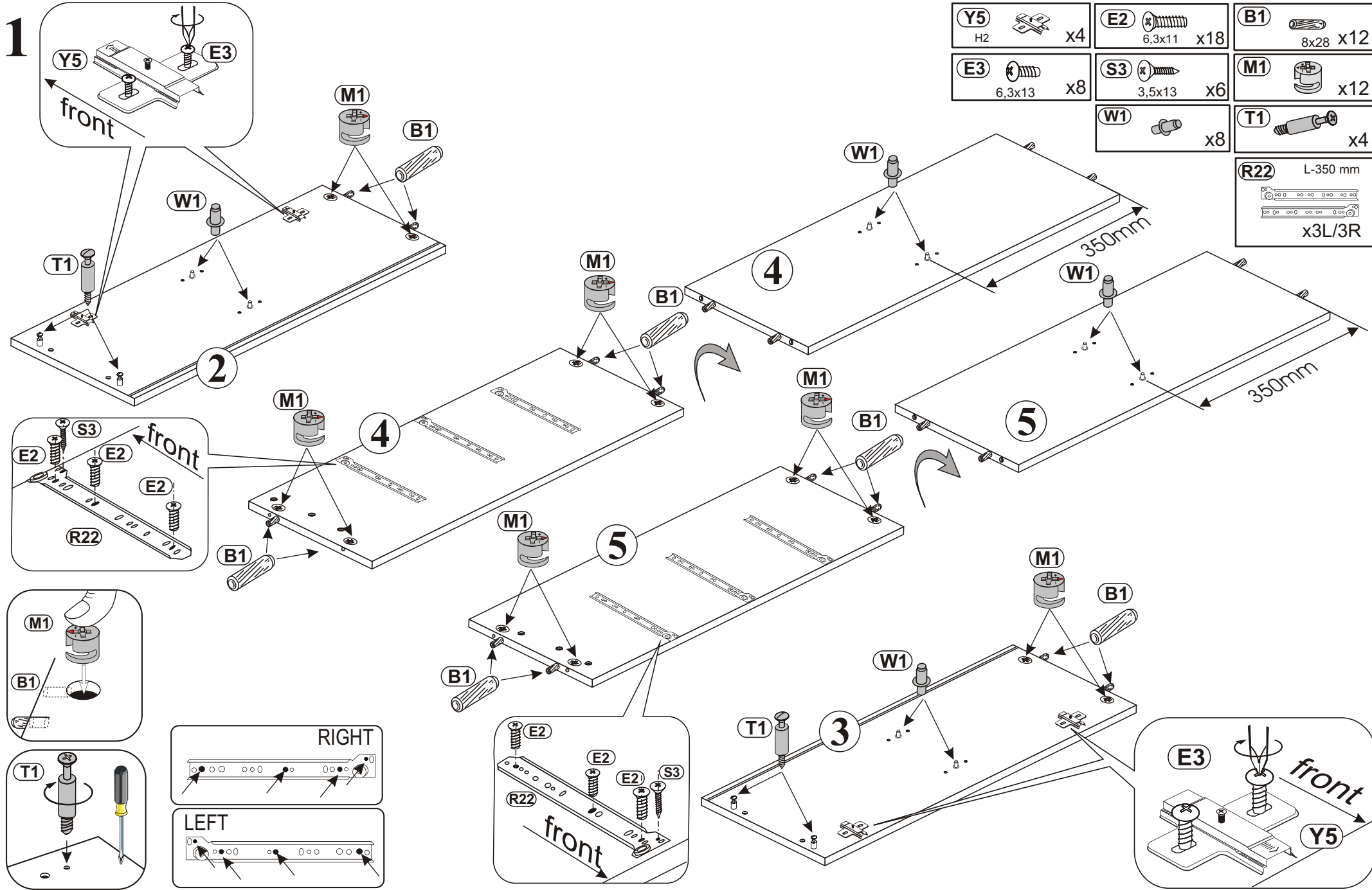

1

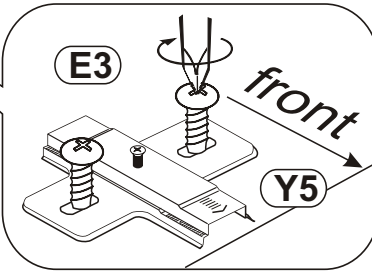
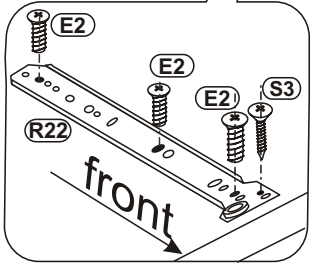
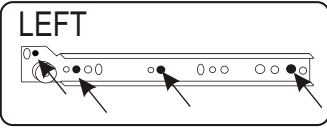
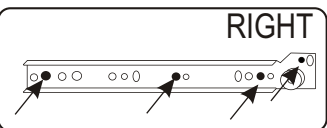
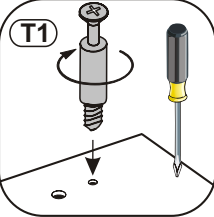
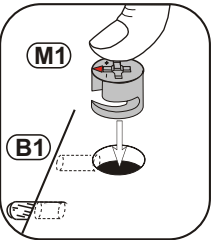
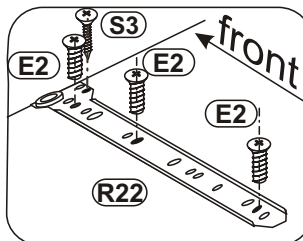

Y5 H2 x4	E2 6,3x11 x18	B1 8x28 x12
E3 6,3x13 x8	S3 3,5x13 x6	M1 x12
W1 x8	T1 x4	
R22 L-350 mm x3L/3R		



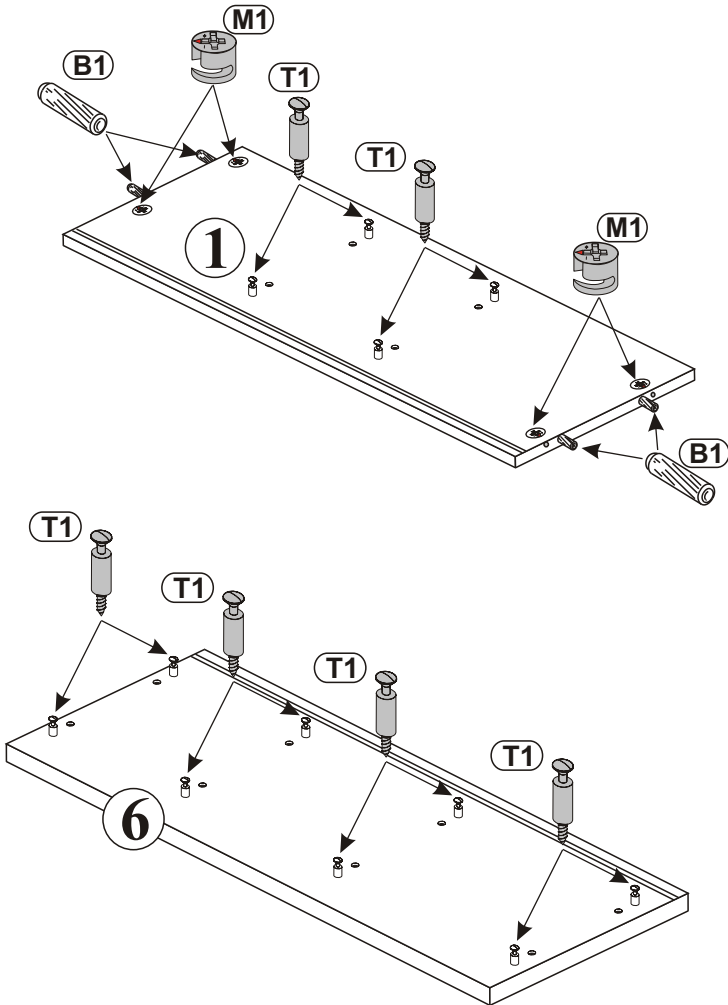

2

- (B1)**  8x28 x4
- (M1)**  x4
- (T1)**  x12

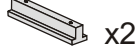
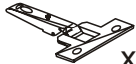

3

- (U20)**  x2
- (Y0)**  26 x4
- (P5)**  4x25 x4
- (S8)**  4x13 mm x8

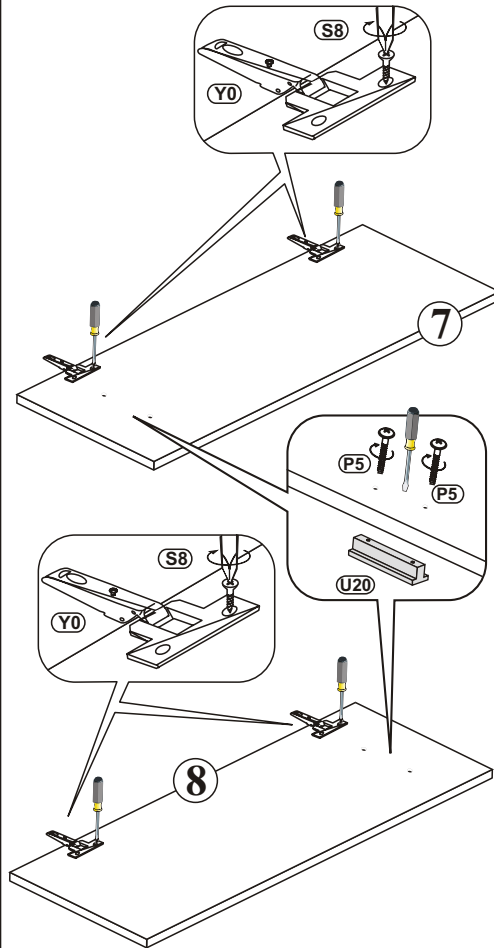

4

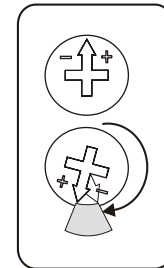
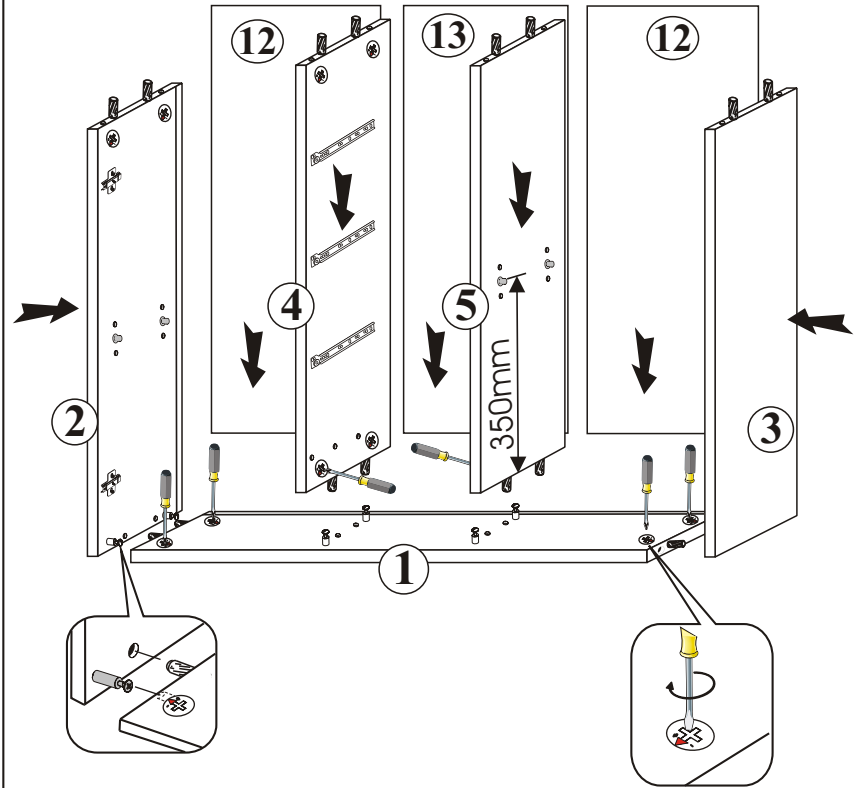

5

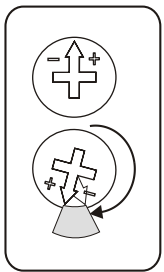
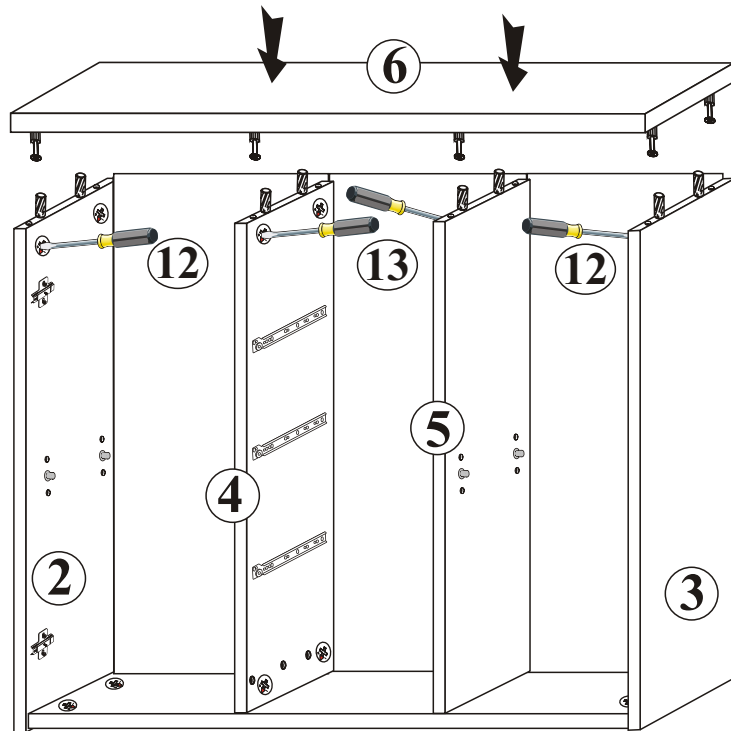

6

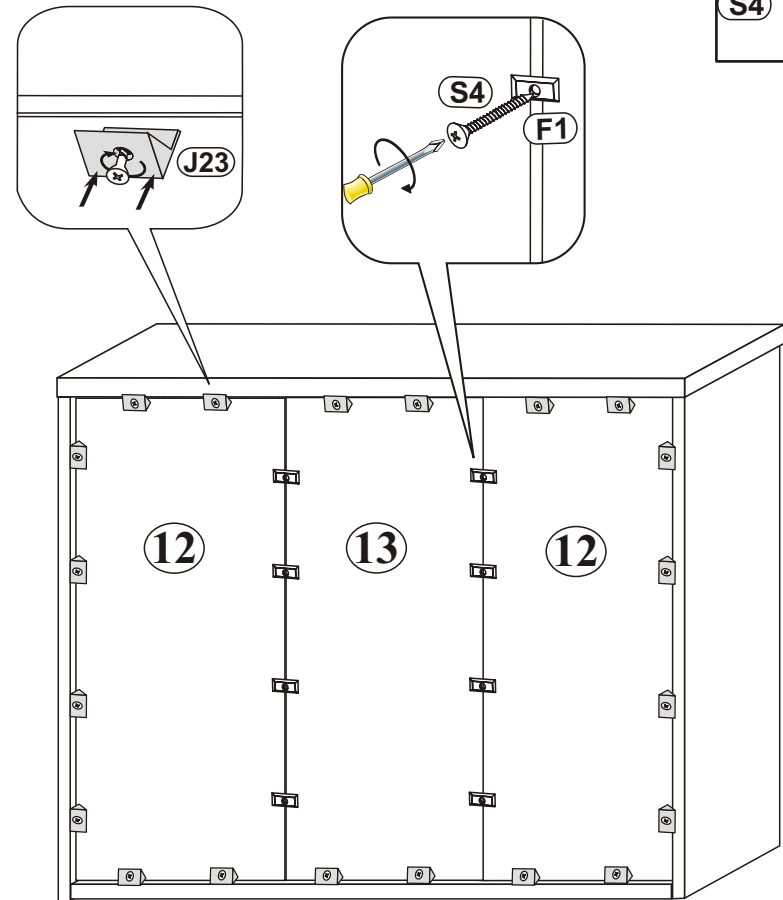

J23  x20

F1  x8

S4  3,0x20 x8

7

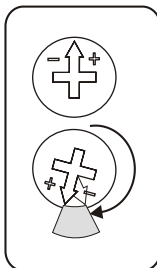
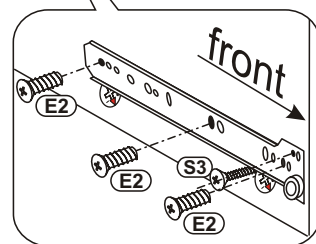
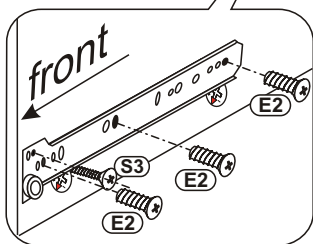
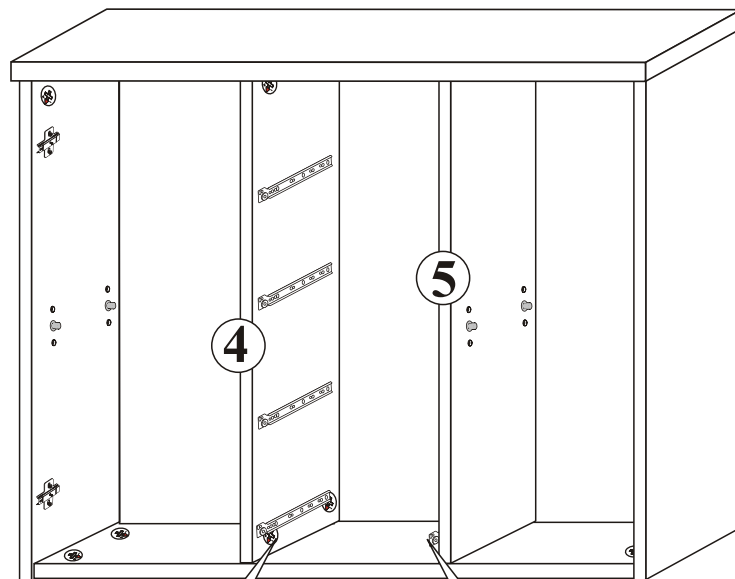
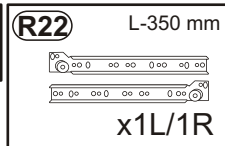
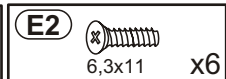

8

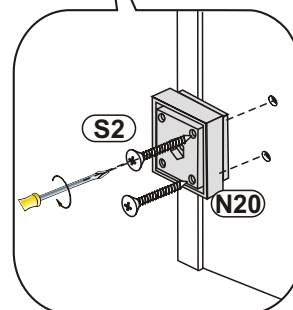
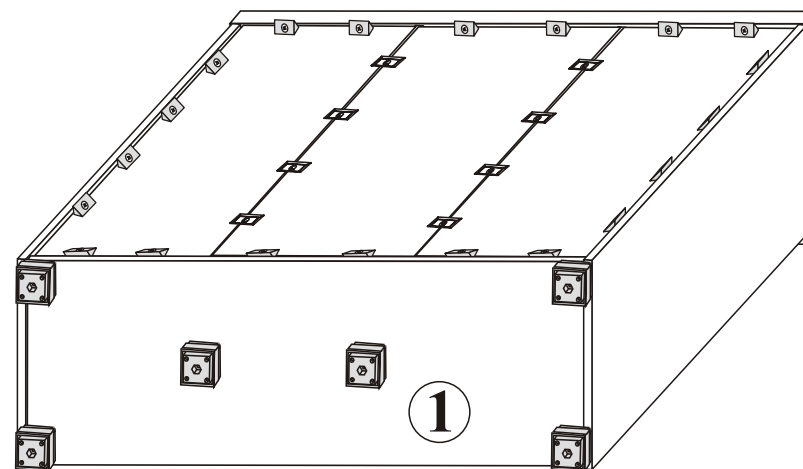
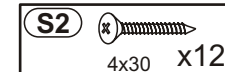
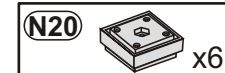

9

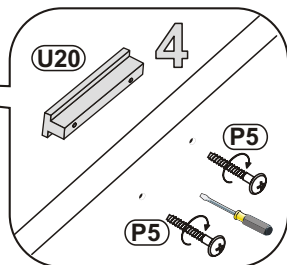
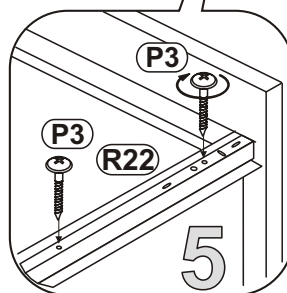
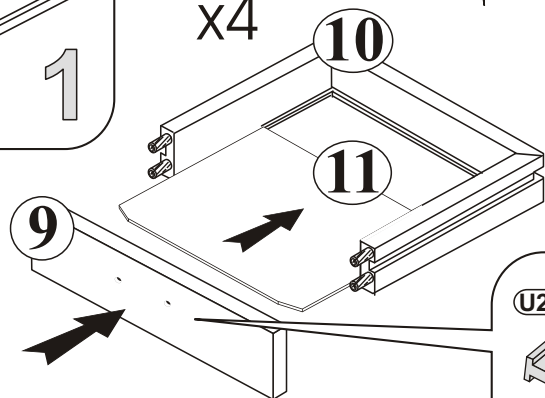
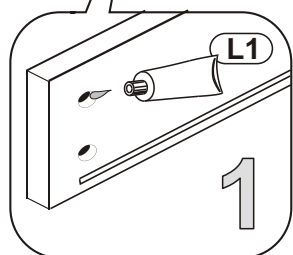
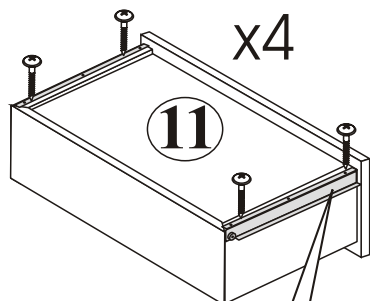
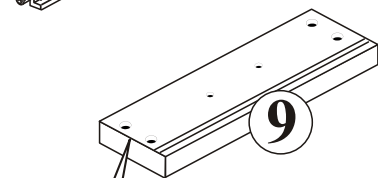
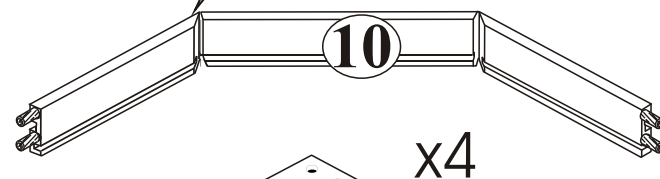
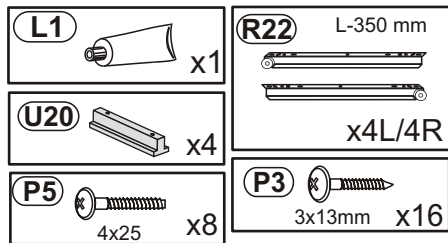
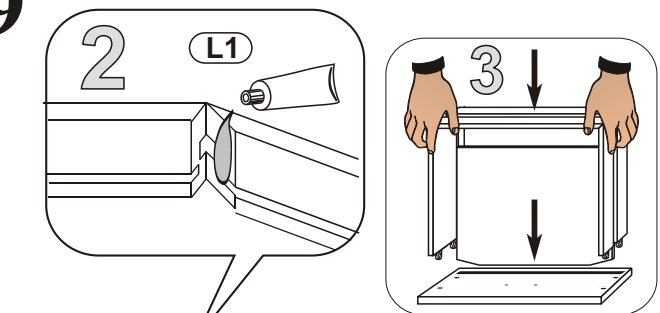

10

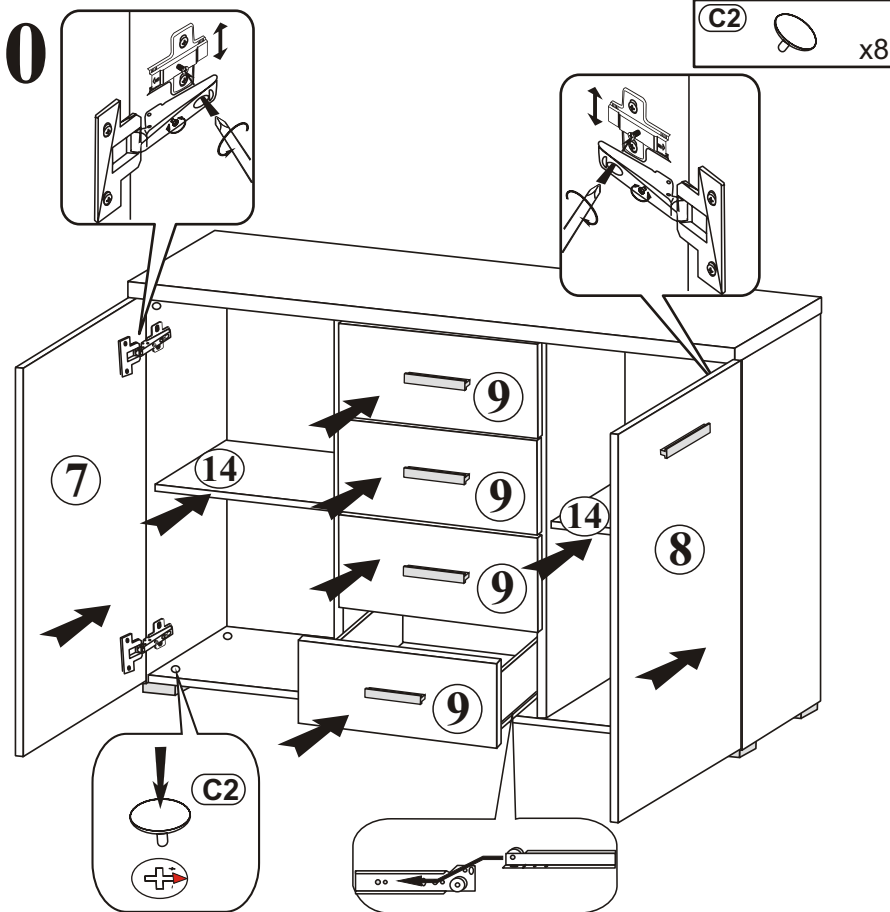

11

