

INSTRUKCJA MONTAŻU

FITTING-UP INSTRUCTION / AUFBAUANLEITUNG
MONTÁŽNÍ NÁVOD / MONTÁŽNY NÁVOD

Producent:
Restol sp. z o.o.
36-055 BRATKOWICE
www.restol.com.pl

Thea AHW-2P

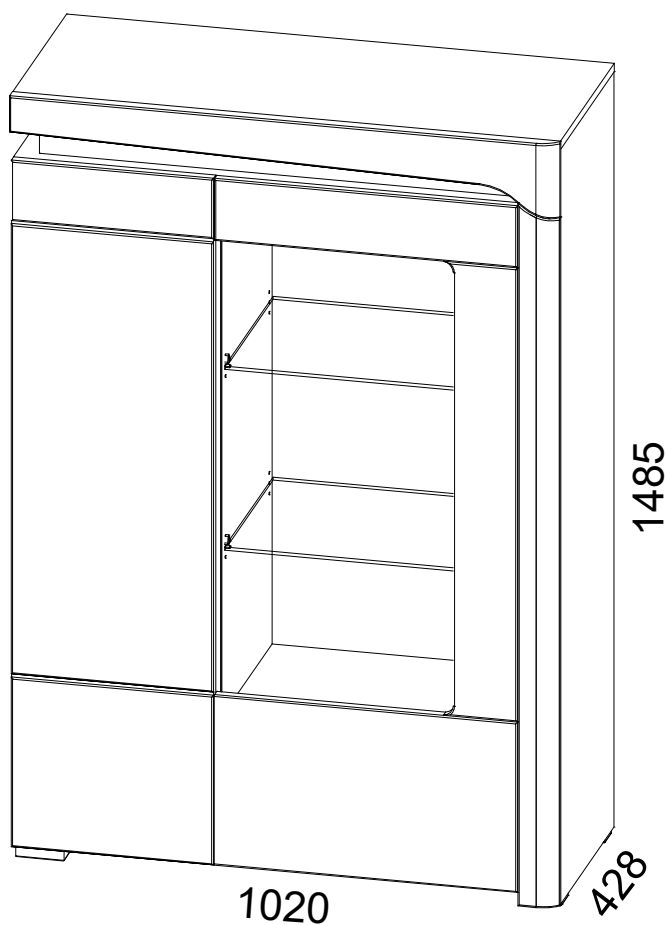

1020 x 1485 x 428 /mm/

POKYN pro ošetřování nábytku!

Díly čistit vlhkým hadříkem nebo papírovou utěrkou.

Nepoužívat chemické čisticí prostředky.

POKYNY k údržbě nábytku.

Prvky nábytku čistit vlhkou handričkou alebo papírovou utěrkou.

Nepoužívat chemické čistiace prostriedky.

WSKAZÓWKA na temat pielęgnacji mebla.

Czyścić elementy wilgotną szmatką lub papierowym ręcznikiem.

Nie używać chemicznych środków czyszczących.

DIRECTION for the furniture cleaning.

Clean elements with the moist wiper or soft paper towel. Do not use any detergents.

Pflegehinweis.

Nur mit feuchtem Lappen, bzw. Papiertuch Ihre Möbel reinigen. Keine chemischen Waschmittel einsetzen.

INSTRUKCJA MONTAŻU
FITTING-UP INSTRUCTION / AUFBAUANLEITUNG
MONTÁŽNÍ NÁVOD / MONTÁŽNY NÁVOD

Thea AHW-2P



Do montażu potrzebne są:

You need for fitting-up:

Zur Montage werden Sie brauchen:

K montáži jsou potřebné:

Na montáž potrebujete:

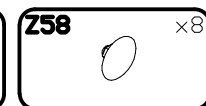
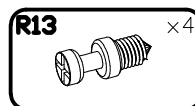
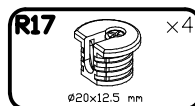
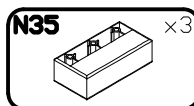
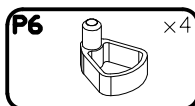
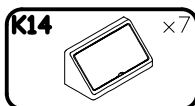
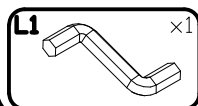
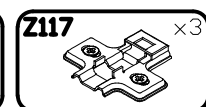
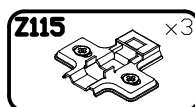
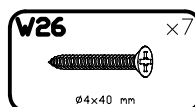
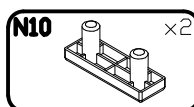
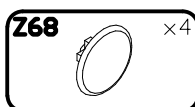
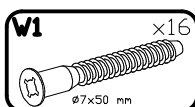
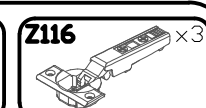
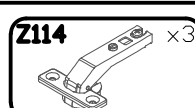
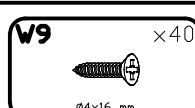
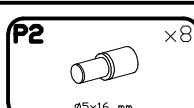
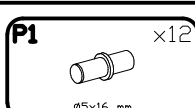
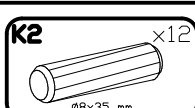
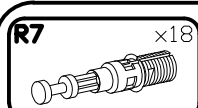
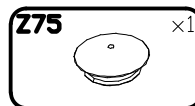
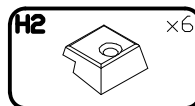
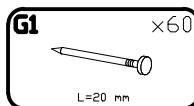
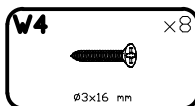
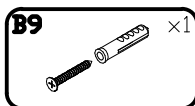
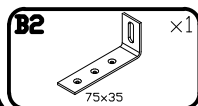
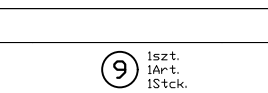
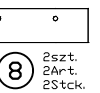
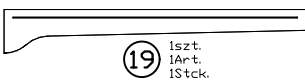
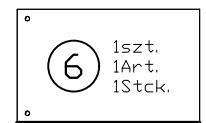
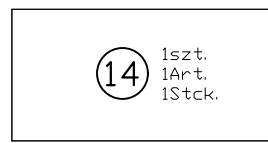
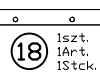
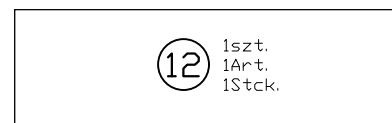
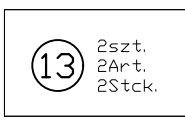
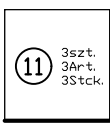
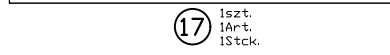
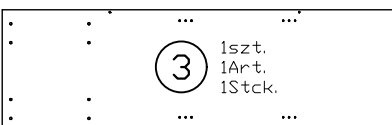
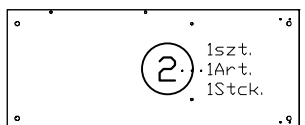
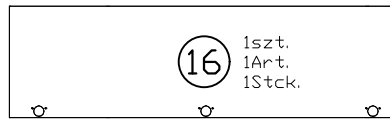
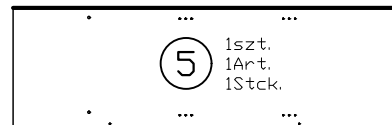
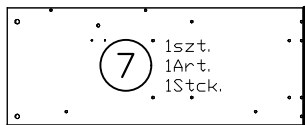
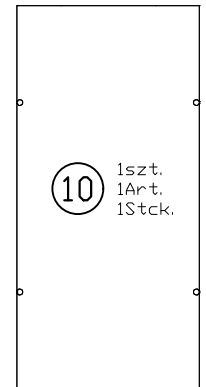
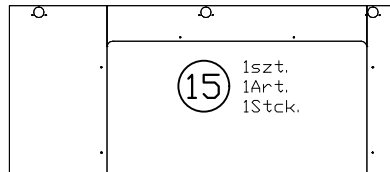
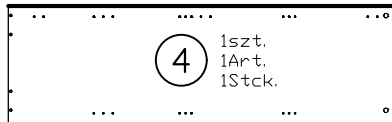
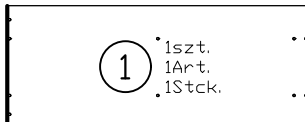
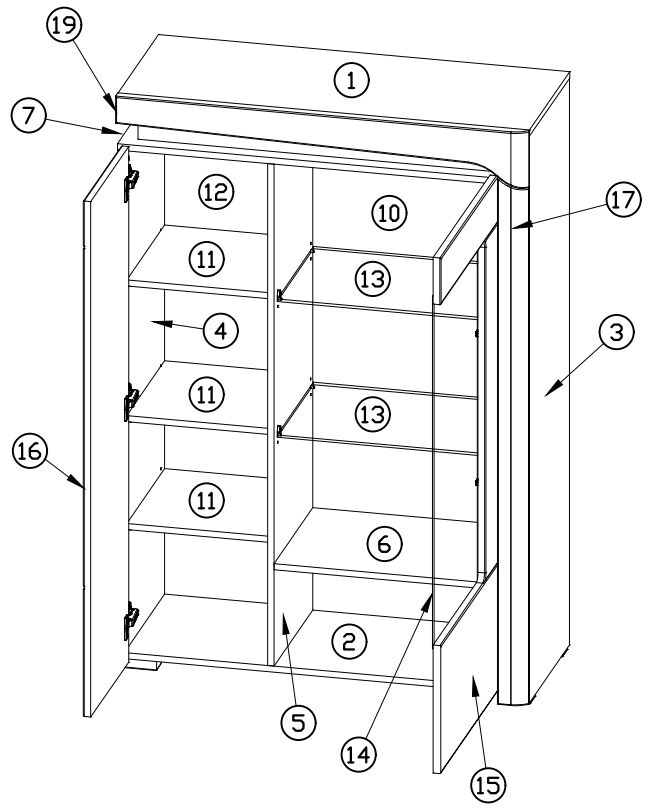
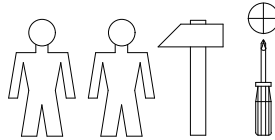

PODCZAS MONTAŻU POSTĘPOWAĆ ZGODNIE Z INSTRUKCJĄ
 WHILE ASSEMBLING FOLLOW THE INSTRUCTION / MONTAGE LAUT DER AUFBAUANLEITUNG DURCHFÜHREN
 PŘI MONTÁŽI POSTUPOVAT PODLE NÁVODU / PRI MONTÁŽI POSTUPUJTE PODĽA NÁVODU

1TH AHW-2P

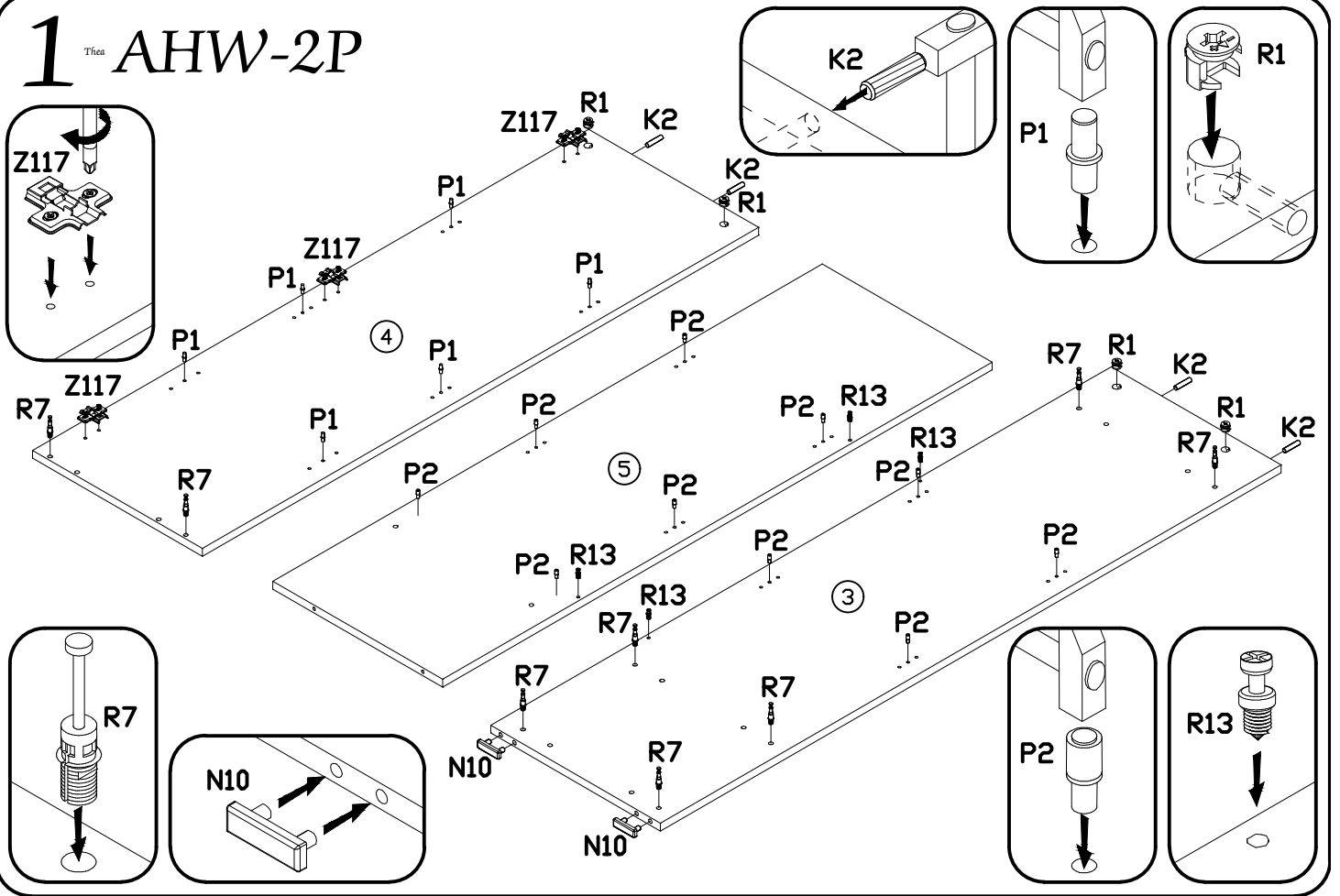

2TH AHW-2P

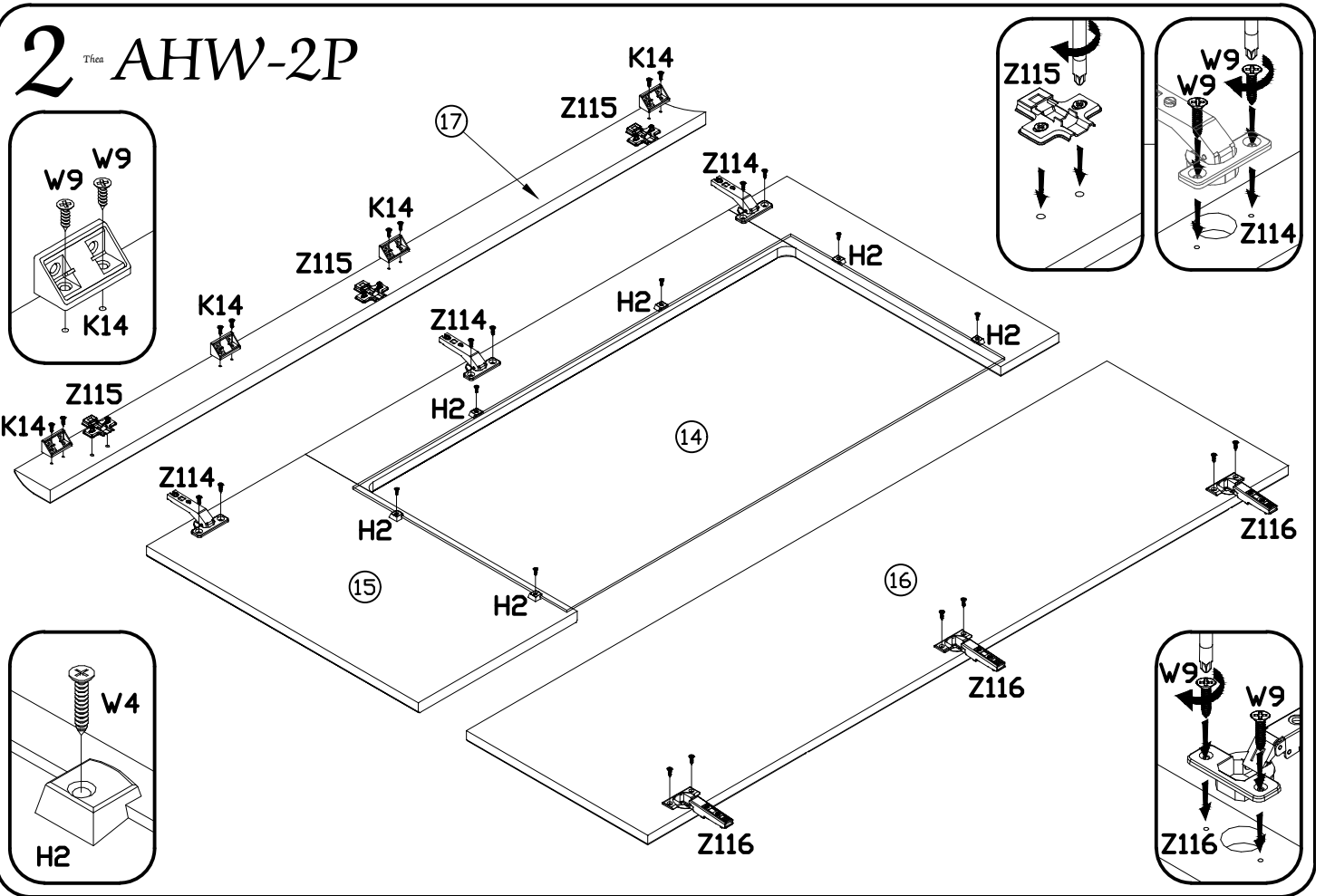

PODCZAS MONTAŻU POSTĘPOWAĆ ZGODNIE Z INSTRUKCJĄ
WHILE ASSEMBLING FOLLOW THE INSTRUCTION / MONTAGE LAUT DER AUFBAUANLEITUNG DURCHFÜHREN
PŘI MONTÁŽI POSTUPOVAT PODLE NÁVODU / PRI MONTÁŽI POSTUPUJTE PODĽA NÁVODU

3TH AHW-2P

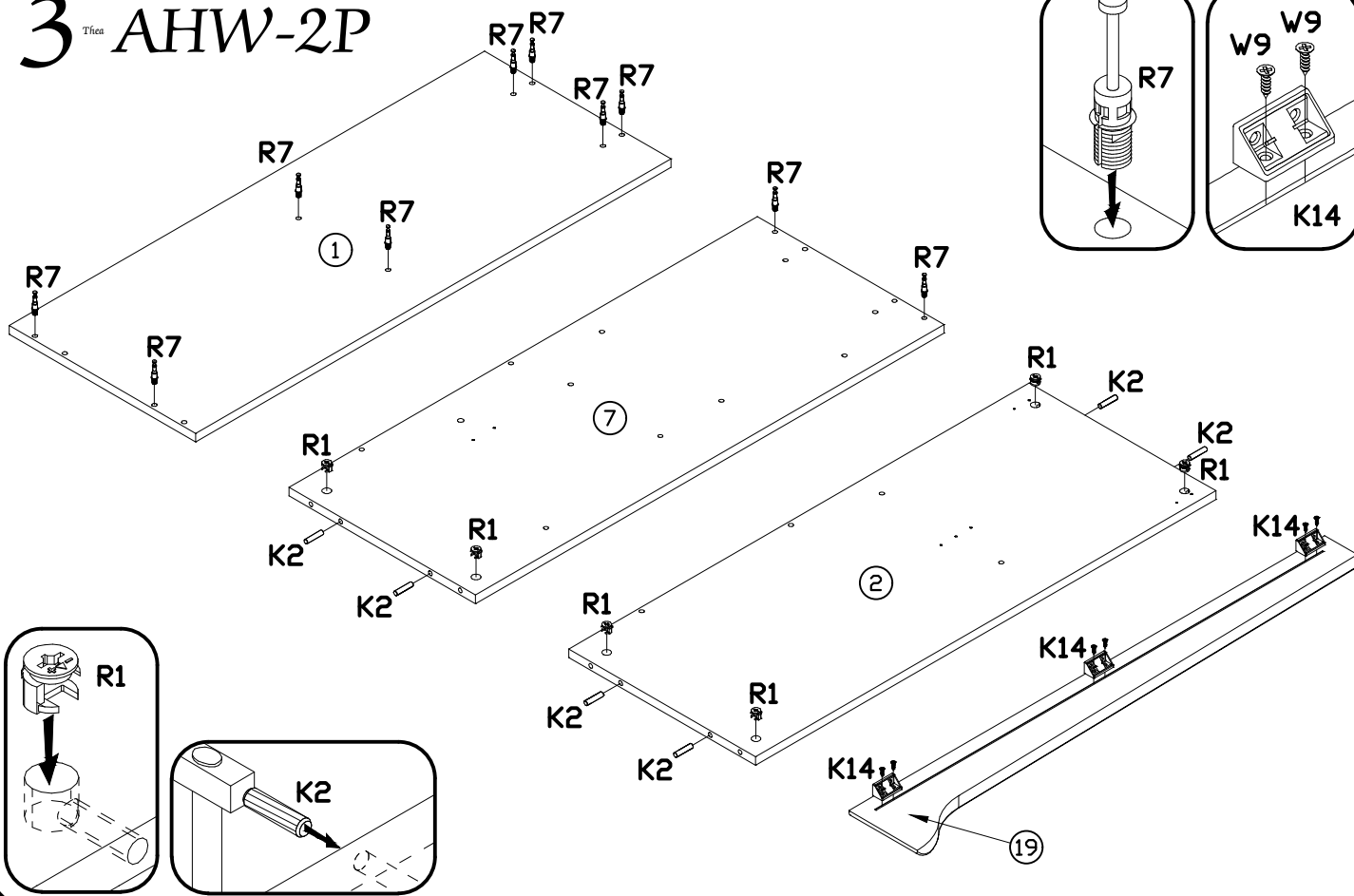

4TH AHW-2P

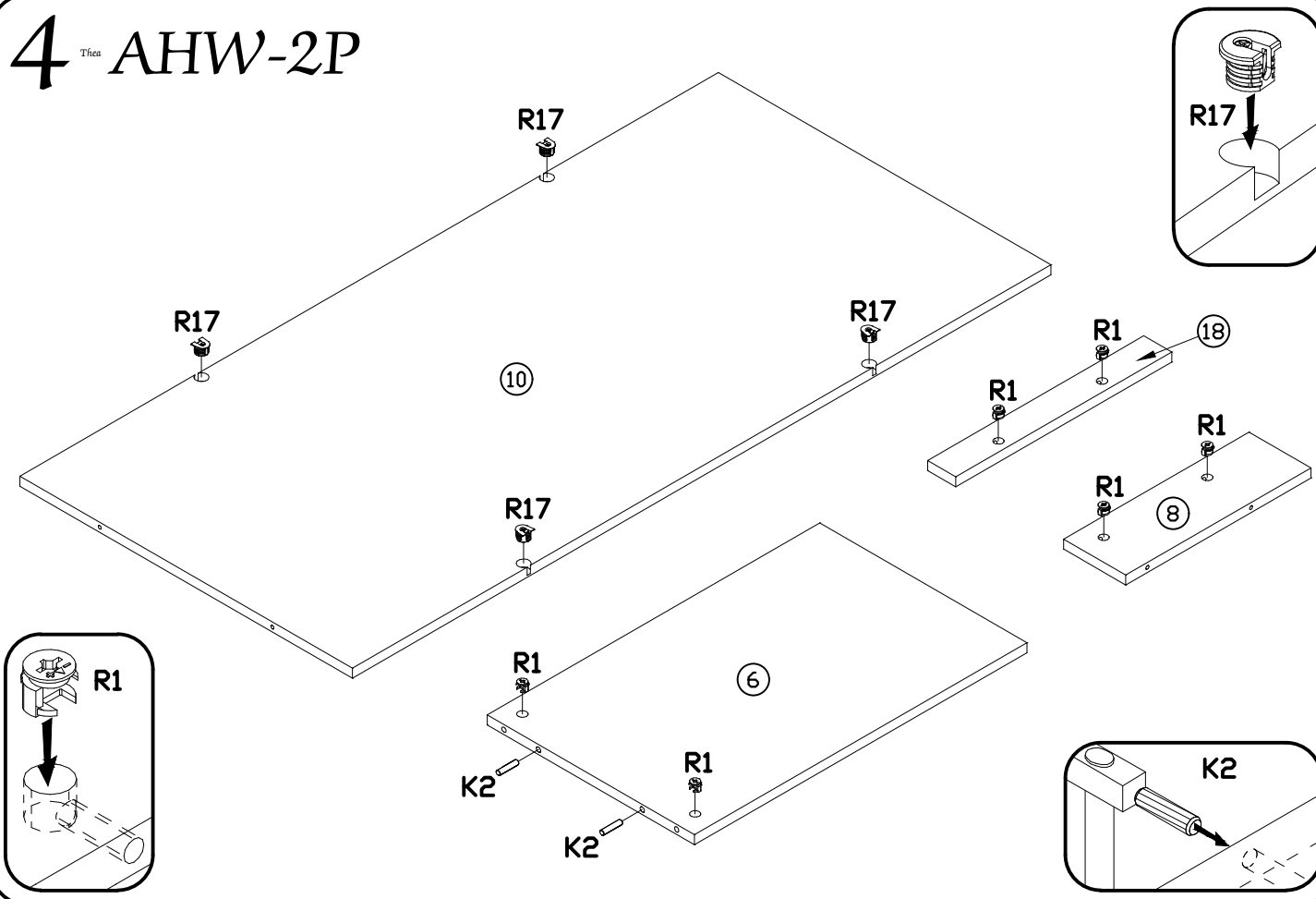

PODCZAS MONTAŻU POSTĘPOWAĆ ZGODNIE Z INSTRUKCJĄ
 WHILE ASSEMBLING FOLLOW THE INSTRUCTION / MONTAGE LAUT DER AUFBAUANLEITUNG DURCHFÜHREN
 PŘI MONTÁŽI POSTUPOVAT PODLE NÁVODU / PRI MONTÁŽI POSTUPOJTE PODĽA NÁVODU

5TH AHW-2P

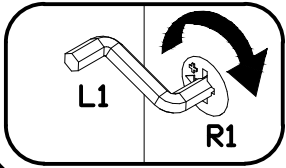
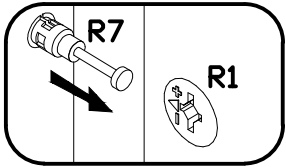
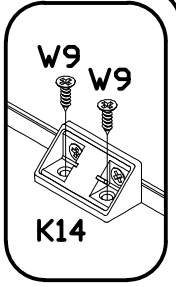
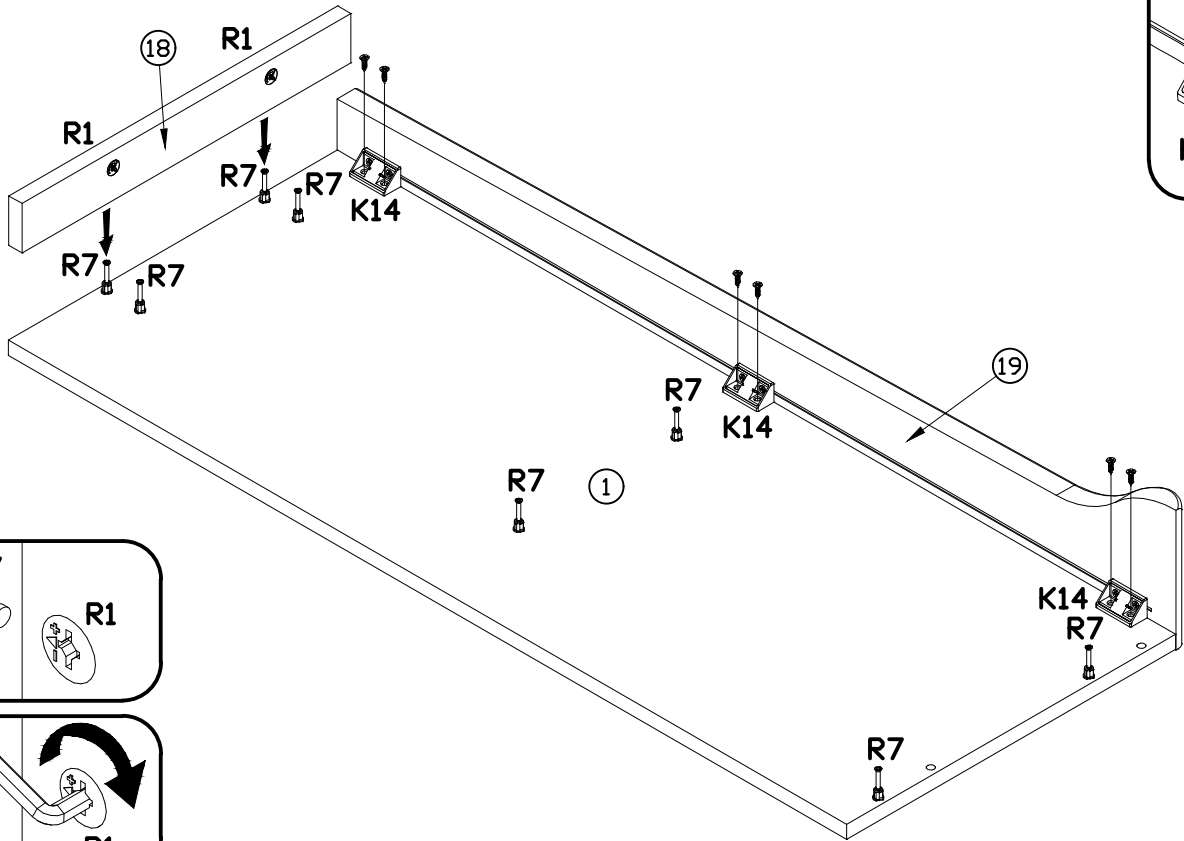

6TH AHW-2P - Opcja NEO-9

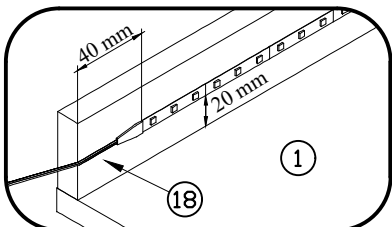
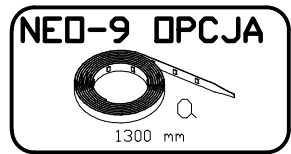
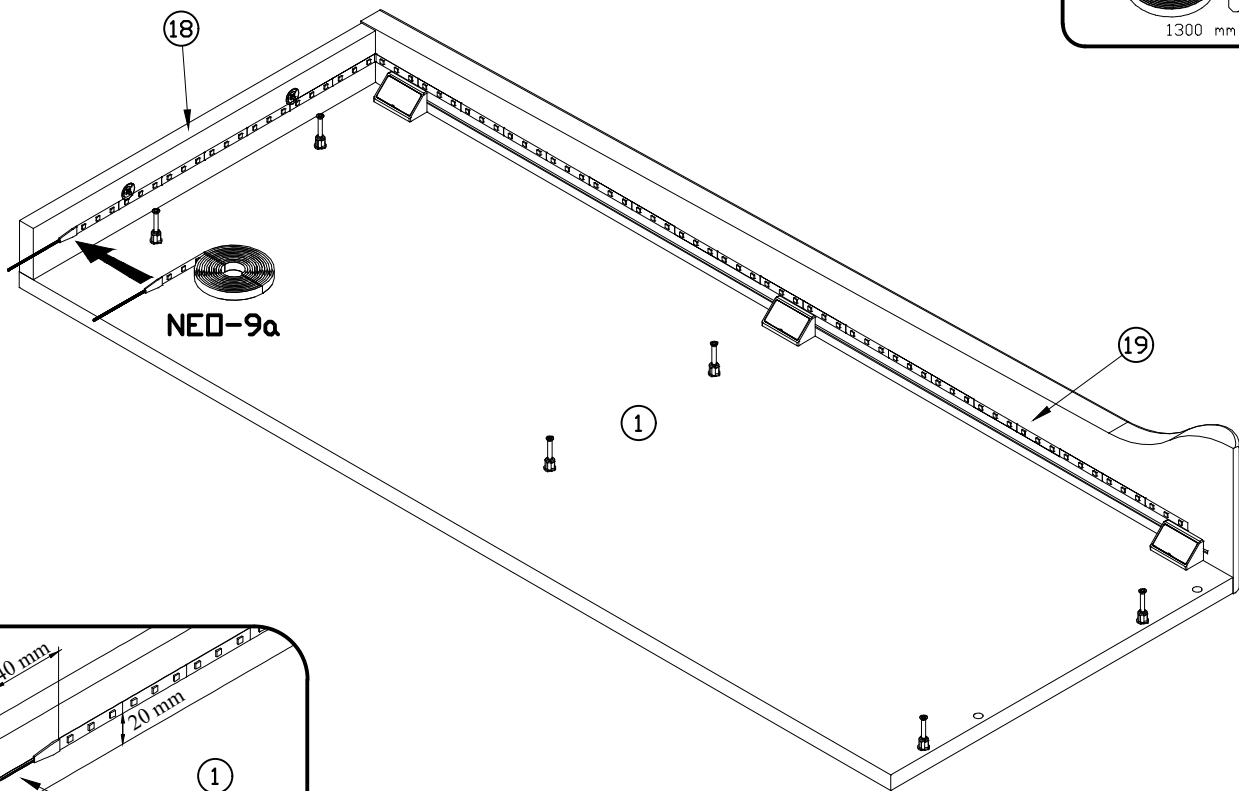

PODCZAS MONTAŻU POSTĘPOWAĆ ZGODNIE Z INSTRUKCJĄ
 WHILE ASSEMBLING FOLLOW THE INSTRUCTION / MONTAGE LAUT DER AUFBAUANLEITUNG DURCHFÜHREN
 PŘI MONTÁŽI POSTUPOVAT PODLE NÁVODU / PRI MONTÁŽI POSTUPOJTE PODĽA NÁVODU

7th AHW-2P

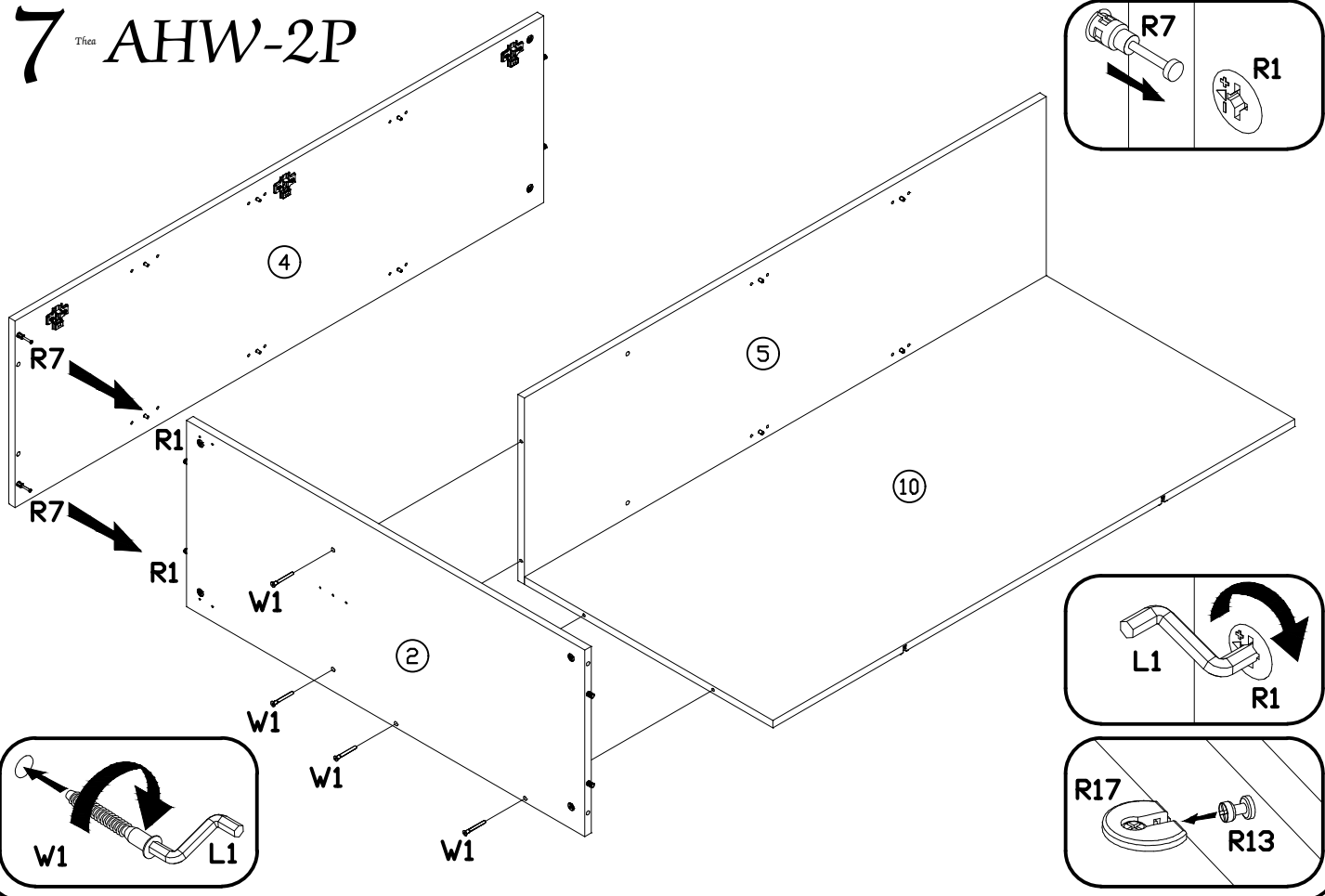

8th AHW-2P - Opcja NEO-9

NEO-9 OPCJA

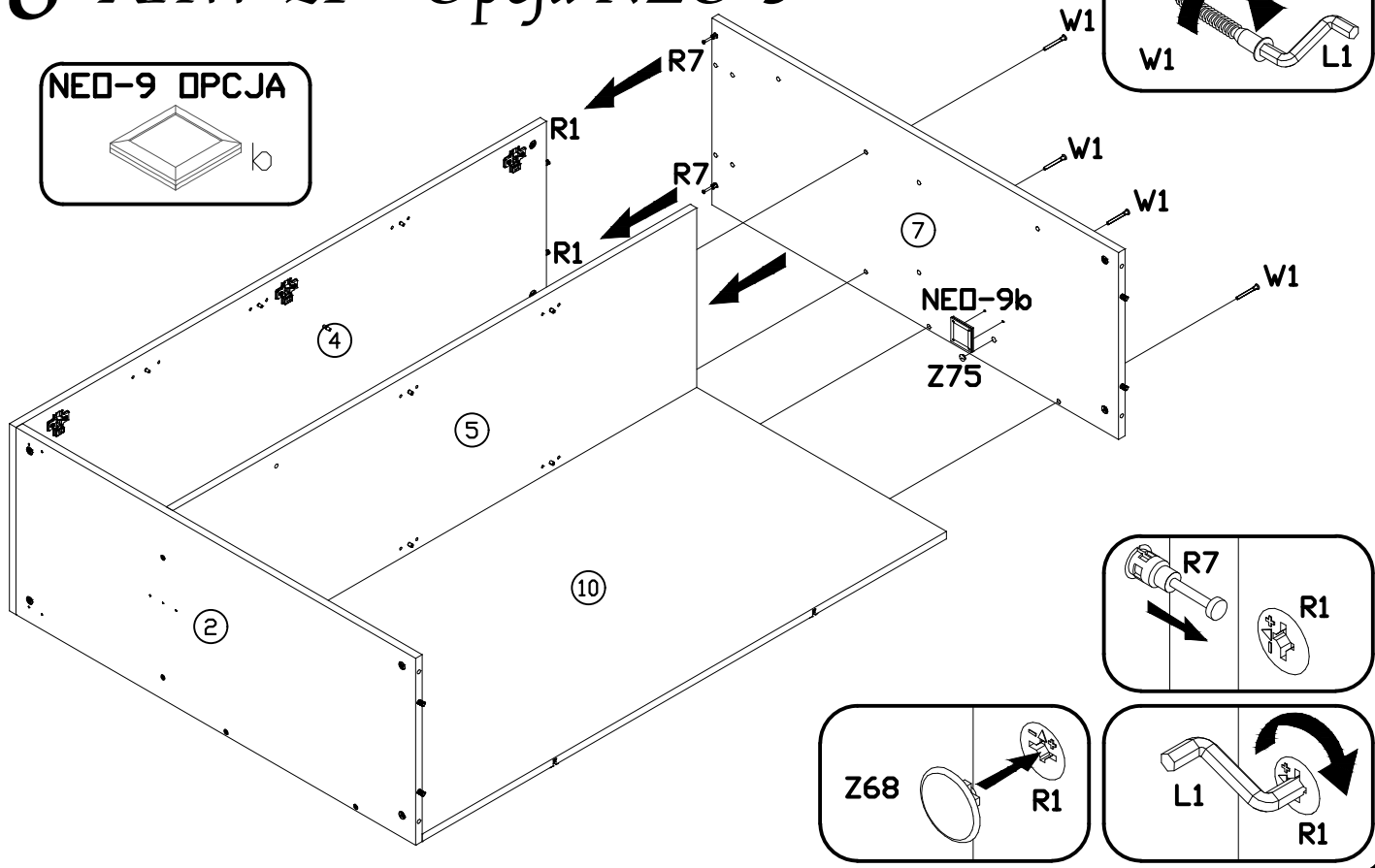
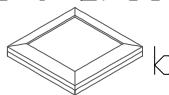

PODZAS MONTAŻU POSTĘPOWAĆ ZGODNIE Z INSTRUKCJĄ
 WHILE ASSEMBLING FOLLOW THE INSTRUCTION / MONTAGE LAUT DER AUFBAUANLEITUNG DURCHFÜHREN
 PŘI MONTÁŽI POSTUPOVAT PODLE NÁVODU / PRI MONTÁŽI POSTUPOJTE PODĽA NÁVODU

9TH AHW-2P

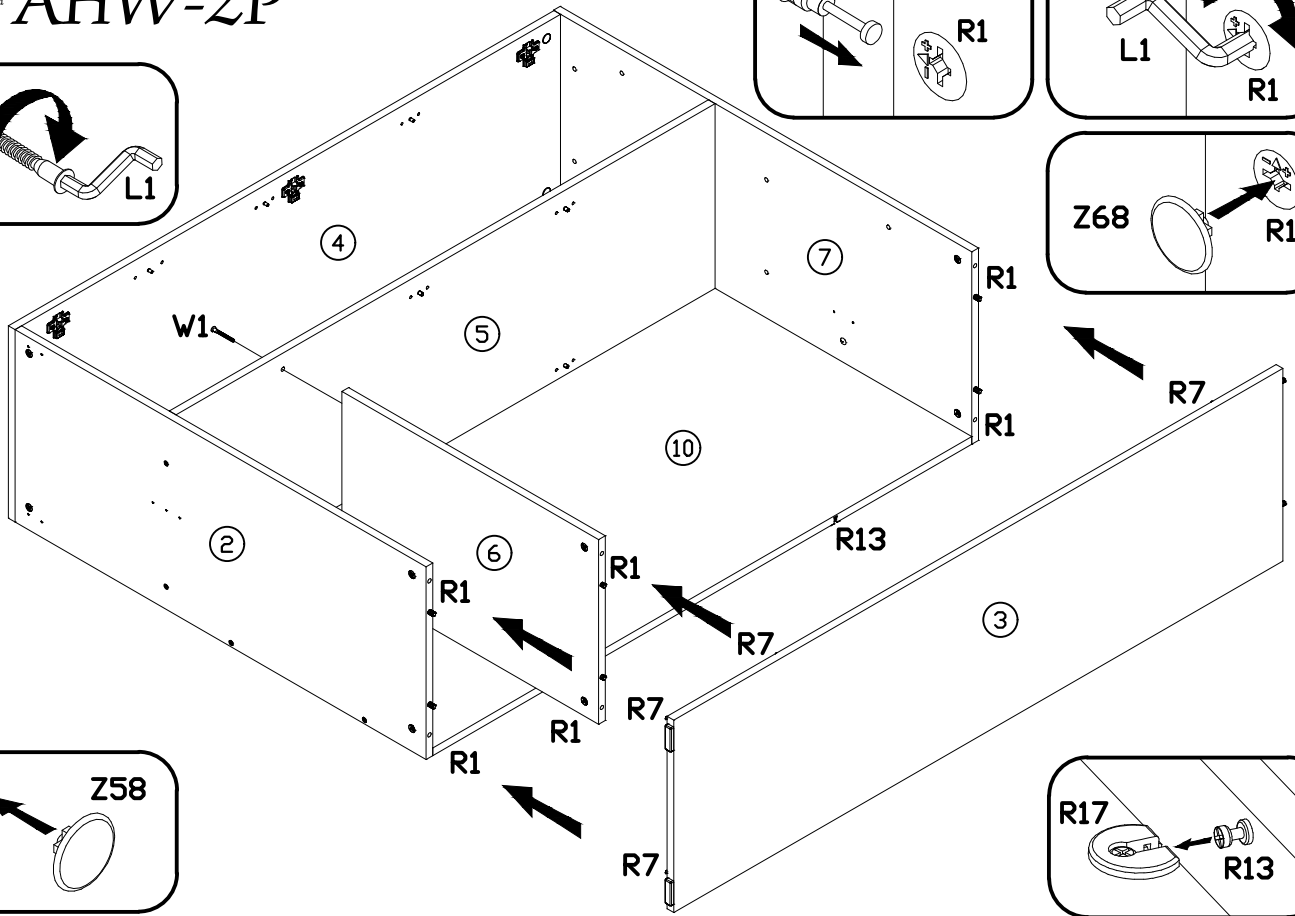
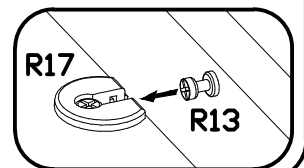
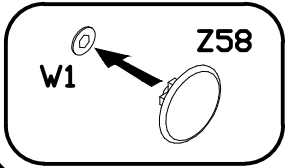
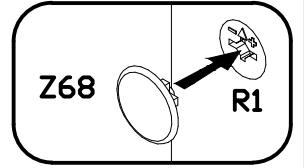
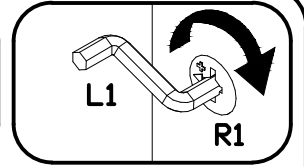
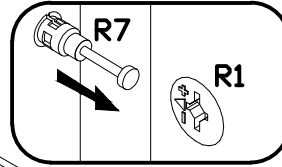
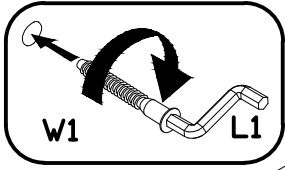

10TH AHW-2P

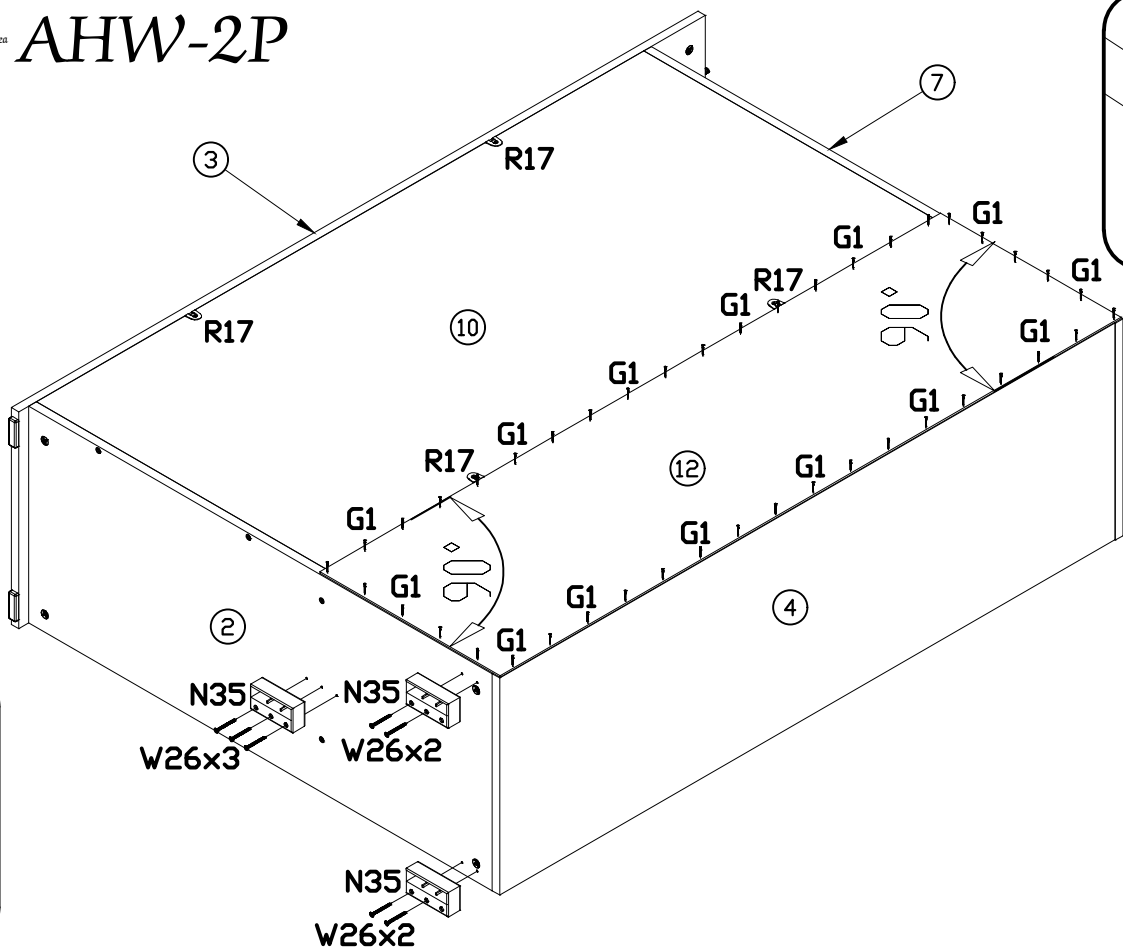
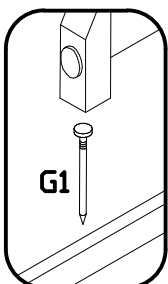
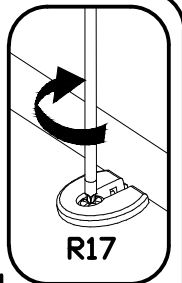

11^{Třída} AHW-2P

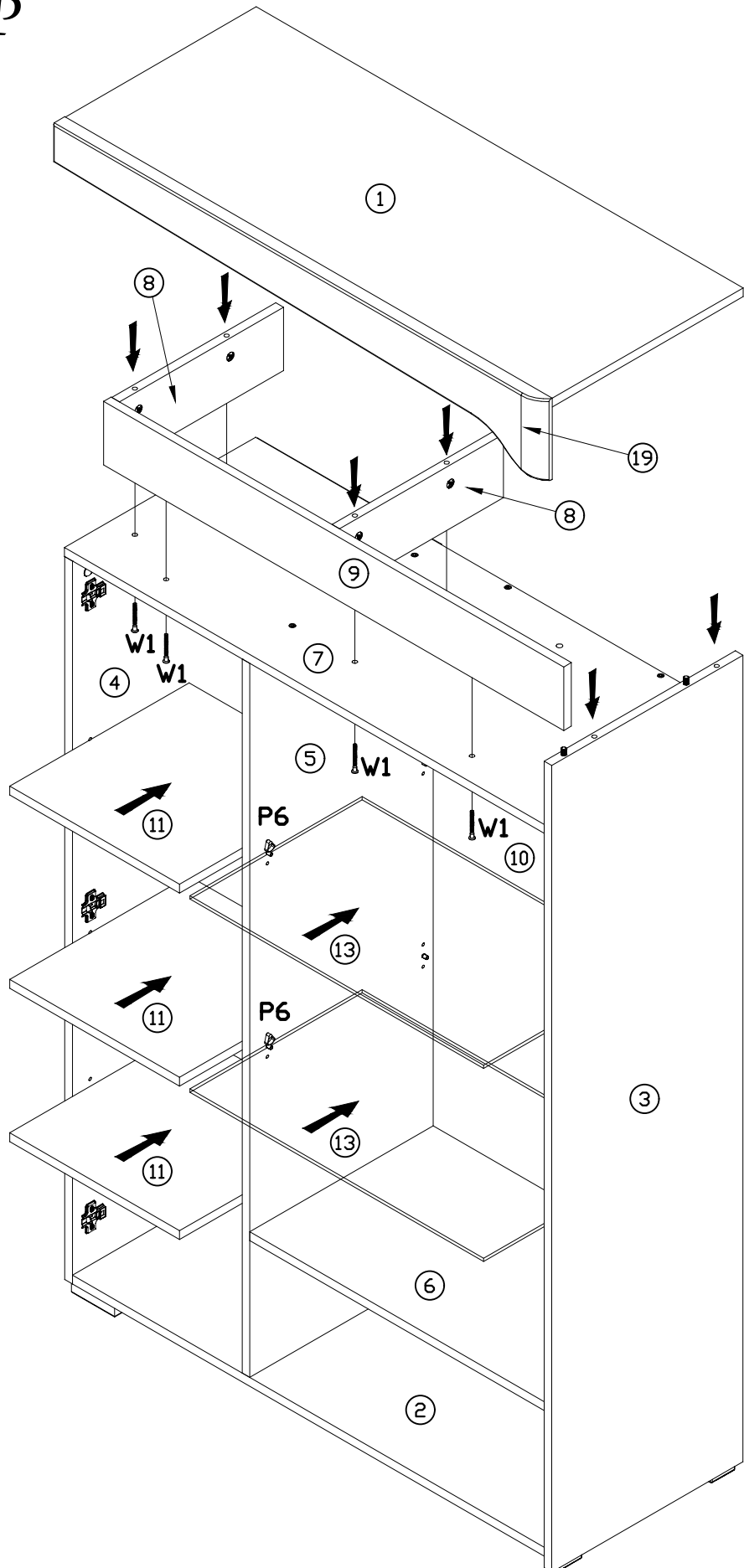
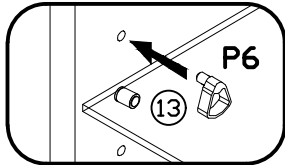
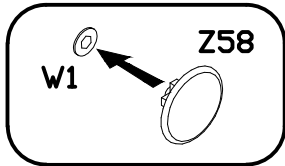
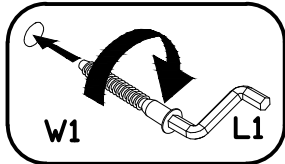
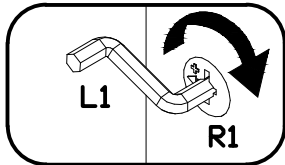
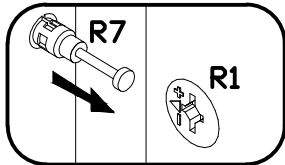

PODCZAS MONTAŻU POSTĘPOWAĆ ZGODNIE Z INSTRUKCJĄ
 WHILE ASSEMBLING FOLLOW THE INSTRUCTION / MONTAGE LAUT DER AUFBAUANLEITUNG DURCHFÜHREN
 PŘI MONTÁŽI POSTUPOVAT PODLE NÁVODU / PRI MONTÁŽI POSTUPOJTE PODĽA NÁVODU

12 Třica AHW-2P

