

Do montażu potrzebne są:  
 Für die Montage dieser Type benötigen Sie:

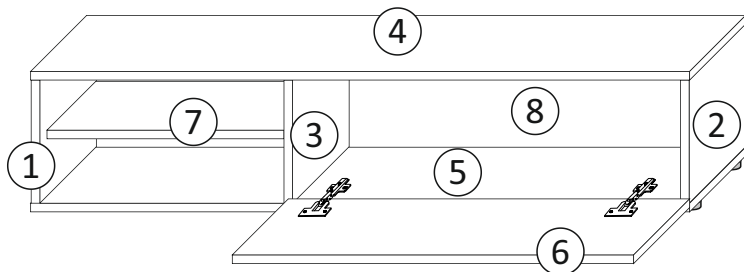
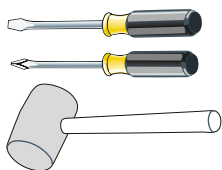
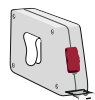
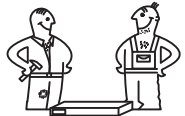

**PL**  
**D**  
**GB**

# INSTRUKCJA MONTAŻOWA MONTAGEANLEITUNG ASSEMBLY INSTRUCTIONS

**D** Sehr geehrter Kunde, sollte ein Teil fehlen oder beschädigt sein, kreuzen Sie bitte dieses deutlich auf der Montageanleitung an und schicken Sie zu uns ab.  
**GB** Dear customer, Should there be any place missing or damaged, kindly mark this place clearly on the attached assembly instructions and return it to us.

**PL** Szanowny Kliencie, gdyby brakowało jakiegokolwiek części lub byłaby uszkodzona proszę to oznaczyć krzyżykiem na instrukcji montażowej i przesłać instrukcję razem z reklamacją.

## Bag 1

<b>K2</b>  x12	<b>T1</b>  x6	<b>M1</b>  x6	<b>S10</b>  3x18 x6	<b>P2</b>  3,5x18 x3	<b>W1</b>  x4	<b>Z1</b>  x6	<b>Z2</b>  x8	<b>K11</b>  x6	<b>K7</b>  x1
----------------------	---------------------	---------------------	------------------------------	-------------------------------	---------------------	---------------------	---------------------	----------------------	---------------------

## Bag 2

<b>U1</b>  x1	<b>P6</b>  4x27 x2
---------------------	-----------------------------

## Bag 3

<b>Z7</b>  x2	<b>S3</b>  4x13 x4
---------------------	-----------------------------

## Bag 4

<b>F1</b>  x5	<b>S4</b>  4x30 x5
---------------------	-----------------------------

## Bag 5

<b>R1</b>  x1	<b>S1</b>  3,5x13 x2	<b>S2</b>  3,5x16 x3
---------------------	-------------------------------	-------------------------------

## Opcje / options

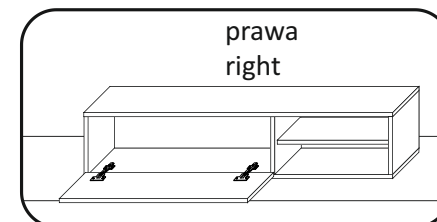
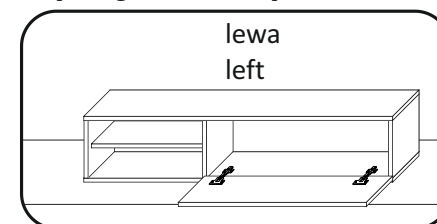

**1**

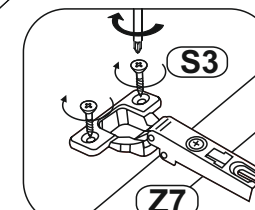
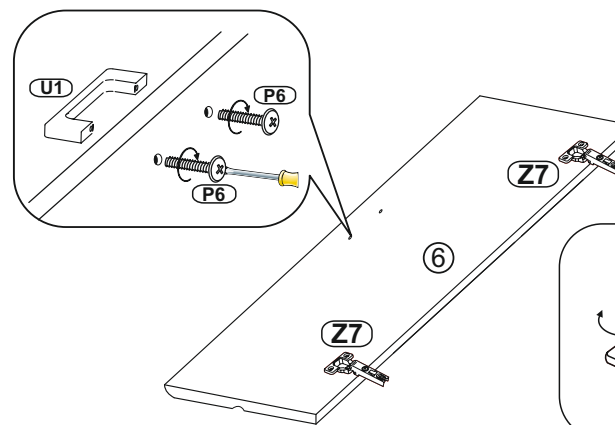
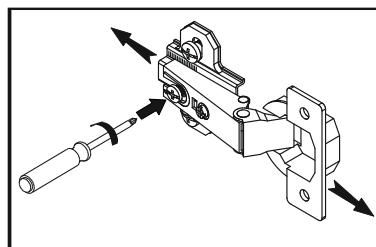
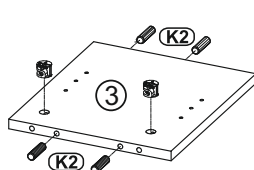
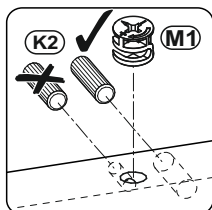
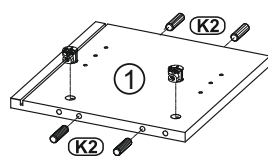
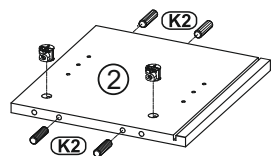

**2**

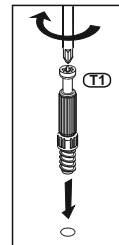
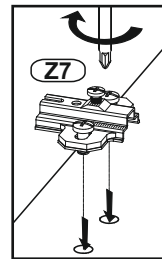
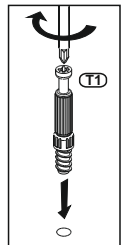
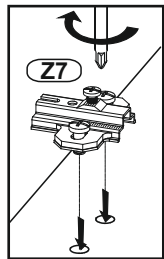
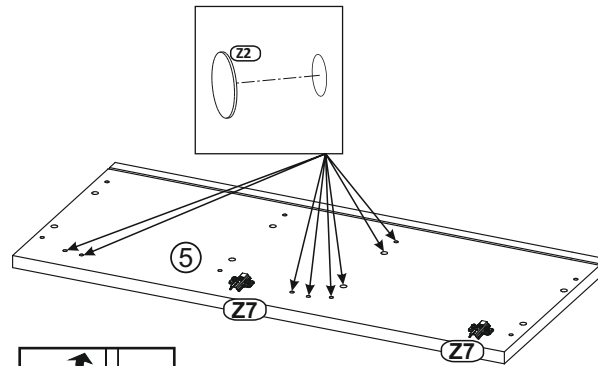
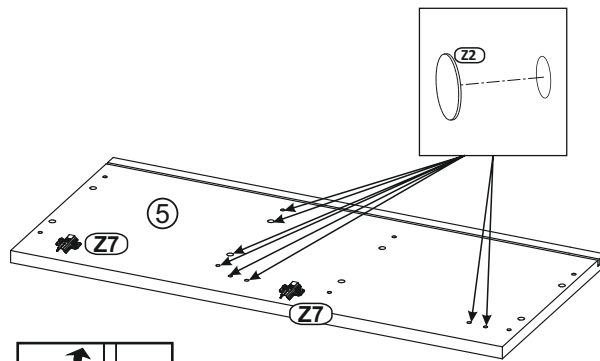
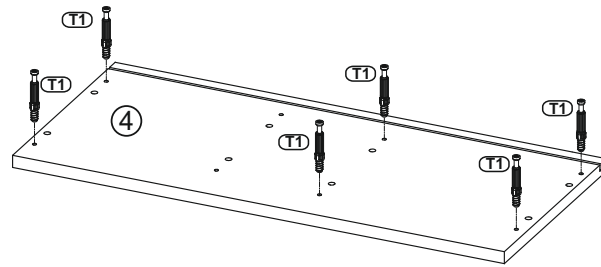
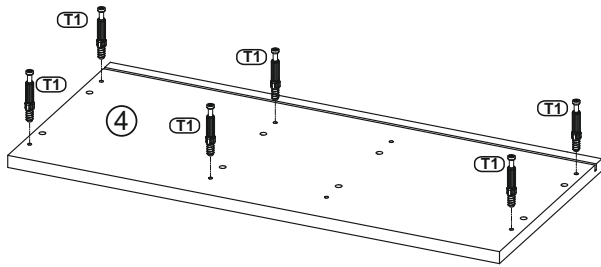
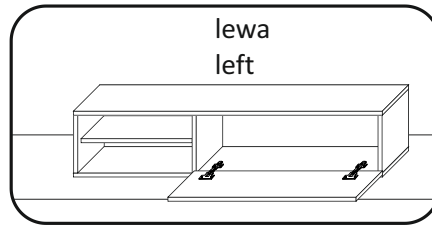
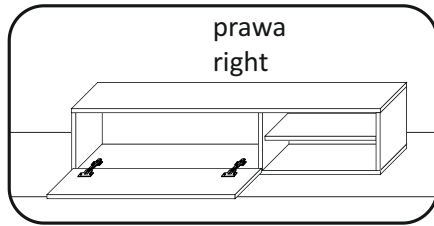

**3**

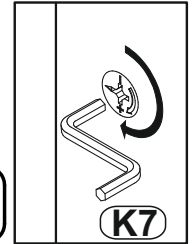
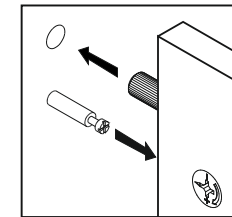
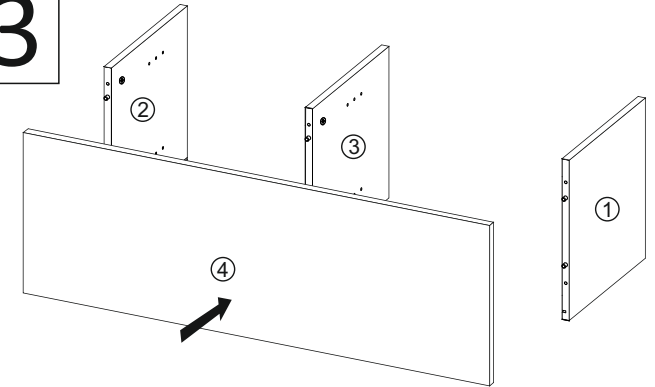

**4**

