

option "b"

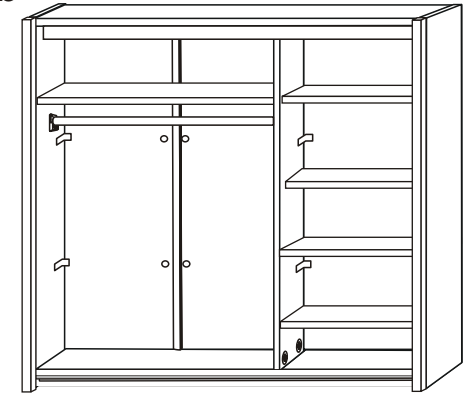

15

14

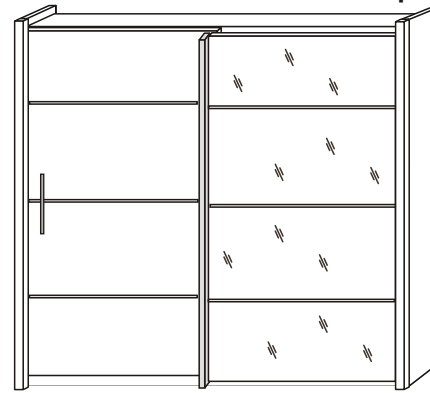
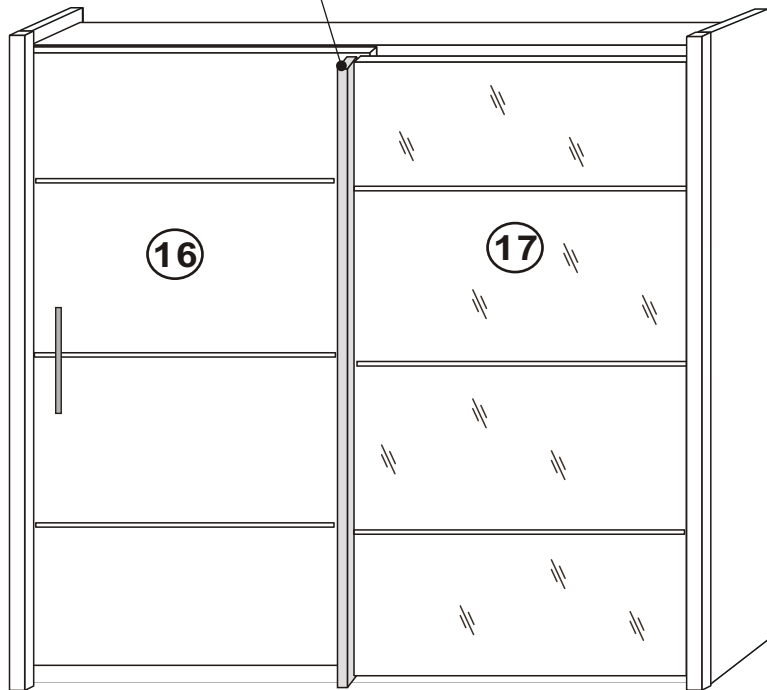









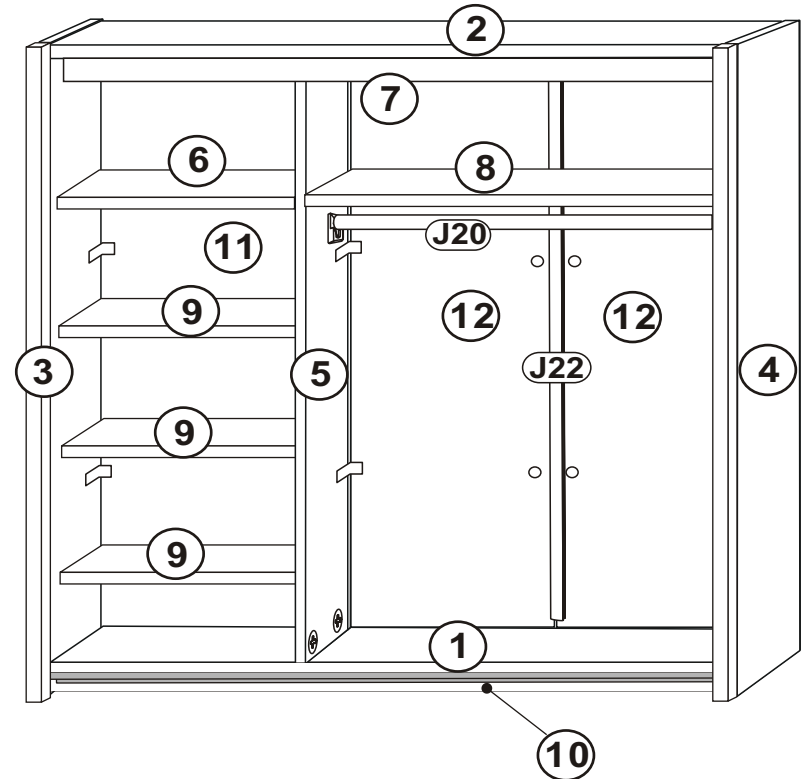



















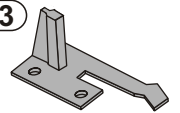
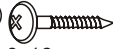
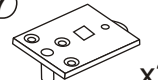

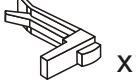
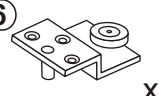

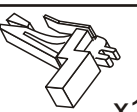
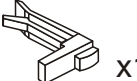
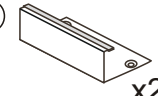

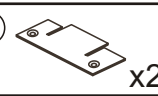
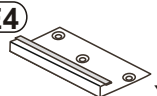

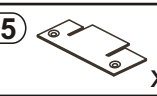
option "a"

13



15

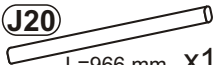

<p>1</p> <p>T6  x8</p> <p>M1  x16</p> <p>T1  x16</p> <p>B1  8x28 x14</p> <p>K1  7x50 x3</p> <p>C1  2 x2</p> <p>P16  4,2x12 x10</p> <p>M6  x10</p> <p>C2  Ø15 x12</p> <p>C3  Ø10 x6</p> <p>W1  x12</p> <p>L1  x1</p> <p>A1  M4x20 x6</p>	<p>2</p> <p>F7  x2</p> <p>S3  3,0x13 x2</p> <p>C11  2 x1</p> <p>C5  Ø5 x4</p> <p>C8  Ø8 x4</p> <p>R3  x2</p> <p>P3  4,0x16 mm x4</p>	<p>3</p> <p>E7  x2</p> <p>E2  4,0x13 x6</p> <p>R2  x1</p> <p>R1  x1</p>	<p>4</p> <p>E6  x2</p> <p>E2  4,0x13 x6</p> <p>R2  x1</p> <p>R1  x1</p>	<p>5</p> <p>E3  x2</p> <p>E1  6,3x11 x4</p> <p>E5  x2</p>	<p>6</p> <p>E4  x2</p> <p>E1  6,3x11 x4</p> <p>E5  x2</p>	<p>7</p> <p>U10  L=256 x1</p> <p>A5  M4x40 x2</p> <p>S3  3,0x13 x8</p> <p>S3  3,0x13 x18</p> <p>L4  x3</p> <p>L5  x1</p>	<p>8</p> <p>J11  x2</p> <p>P13  3,5x13 mm x4</p> <p>T13  x2</p> <p>S15  x2</p>
---	---	--	--	--	--	---	--

J20  L=966 mm x1

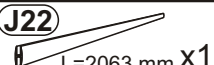
J22  L=2063 mm x1

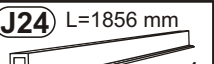
J24  L=1856 mm x1

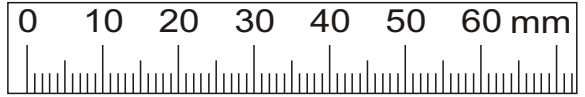

0 10 20 30 40 50 60 mm



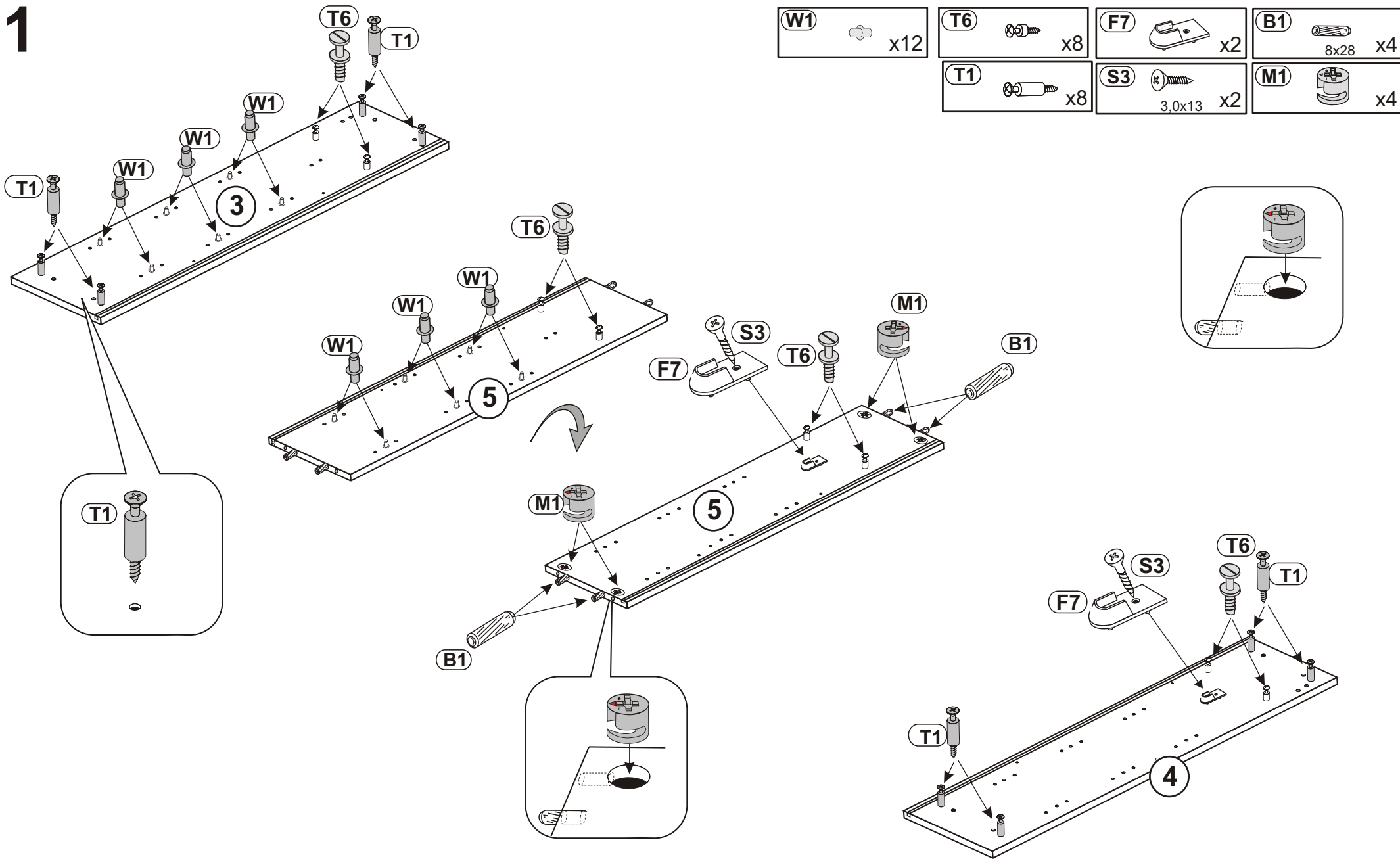

1

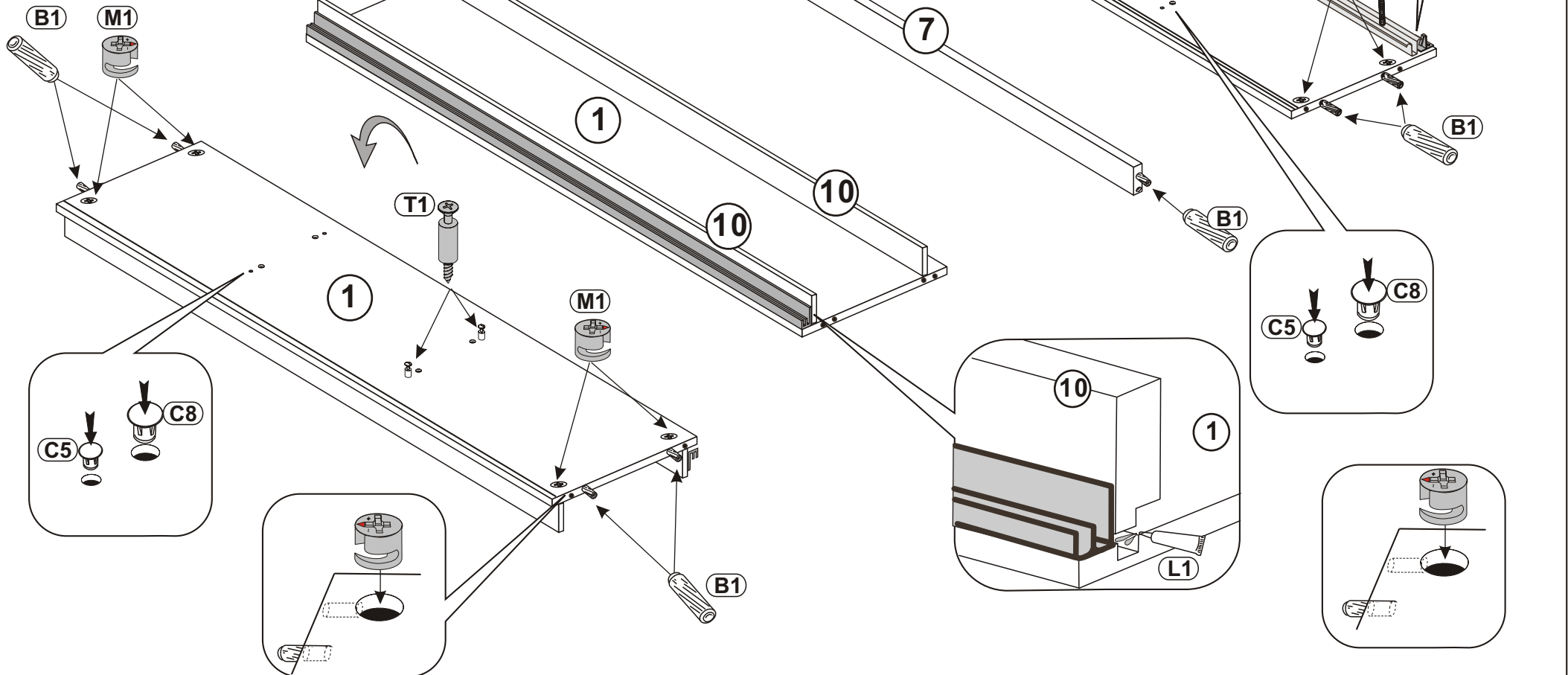
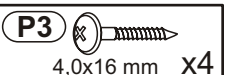
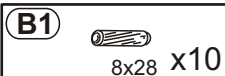
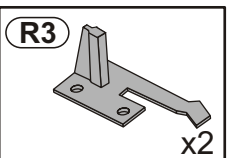
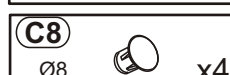
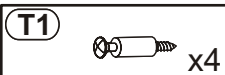
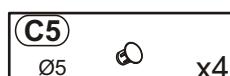
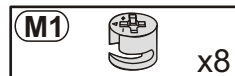

2



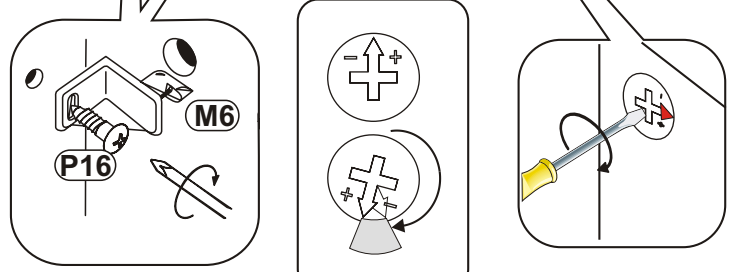
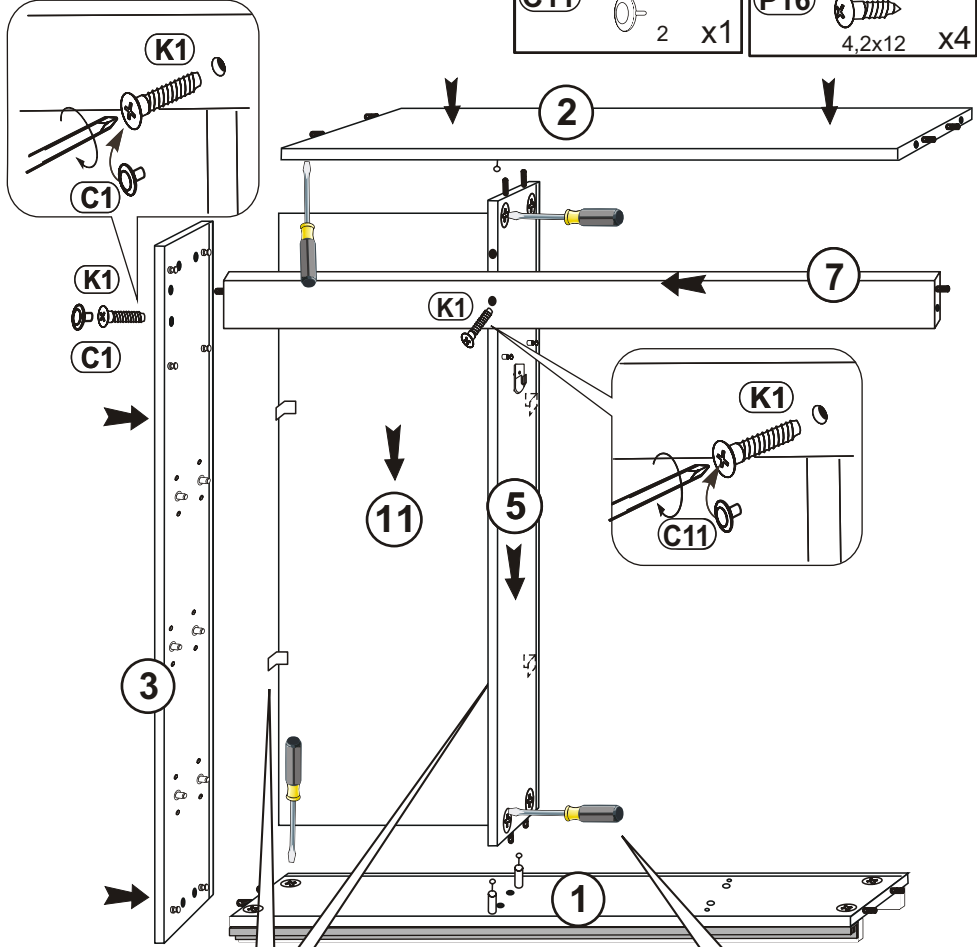

3

- K1**  x2
- C1**  2 x1
- M6**  x4
- C11**  2 x1
- P16**  x4

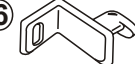
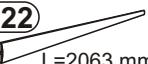

4

- K1**  x1
- P16**  x4
- C1**  2 x1
- M6**  x4
- J22**  L=2063 mm X1

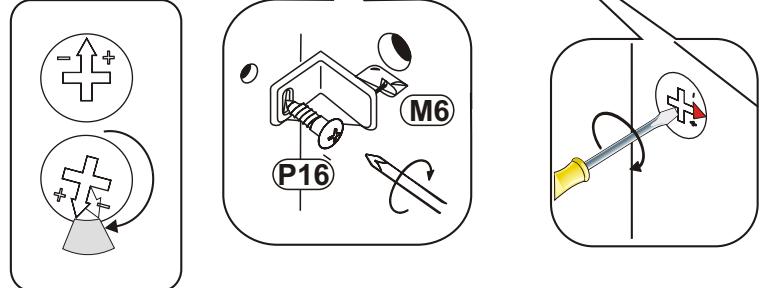
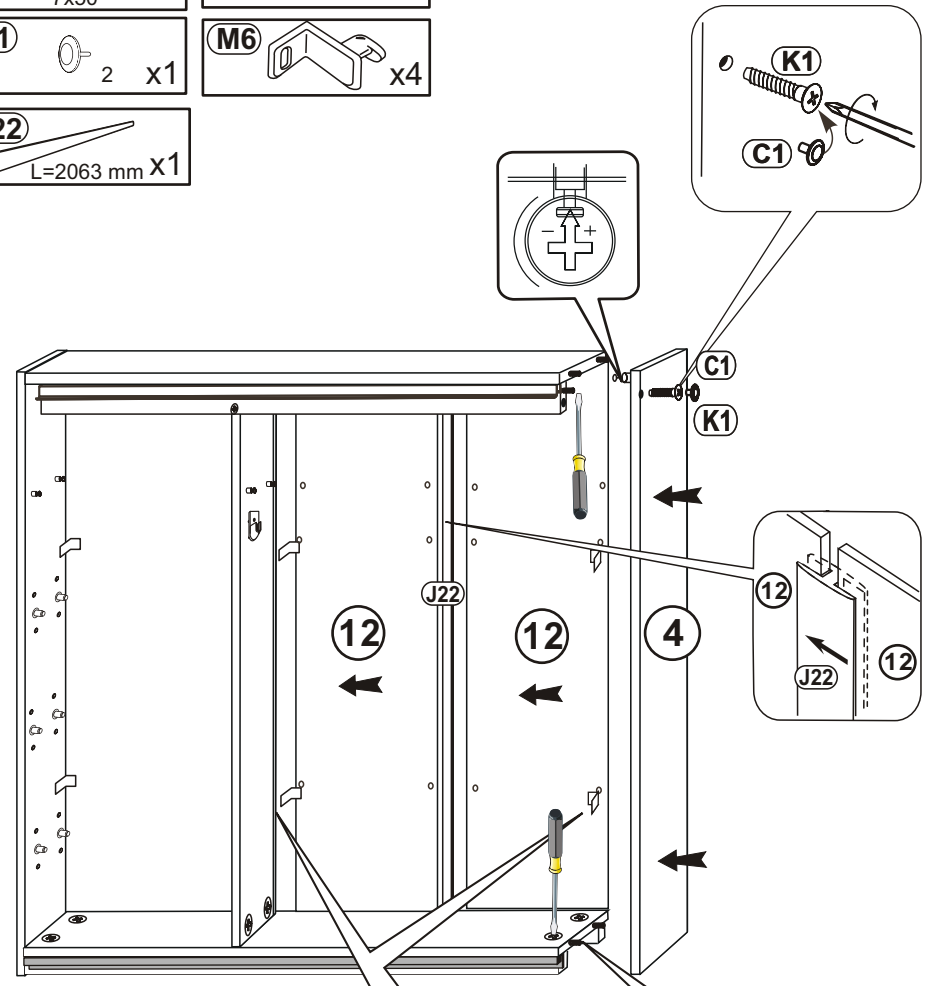

5

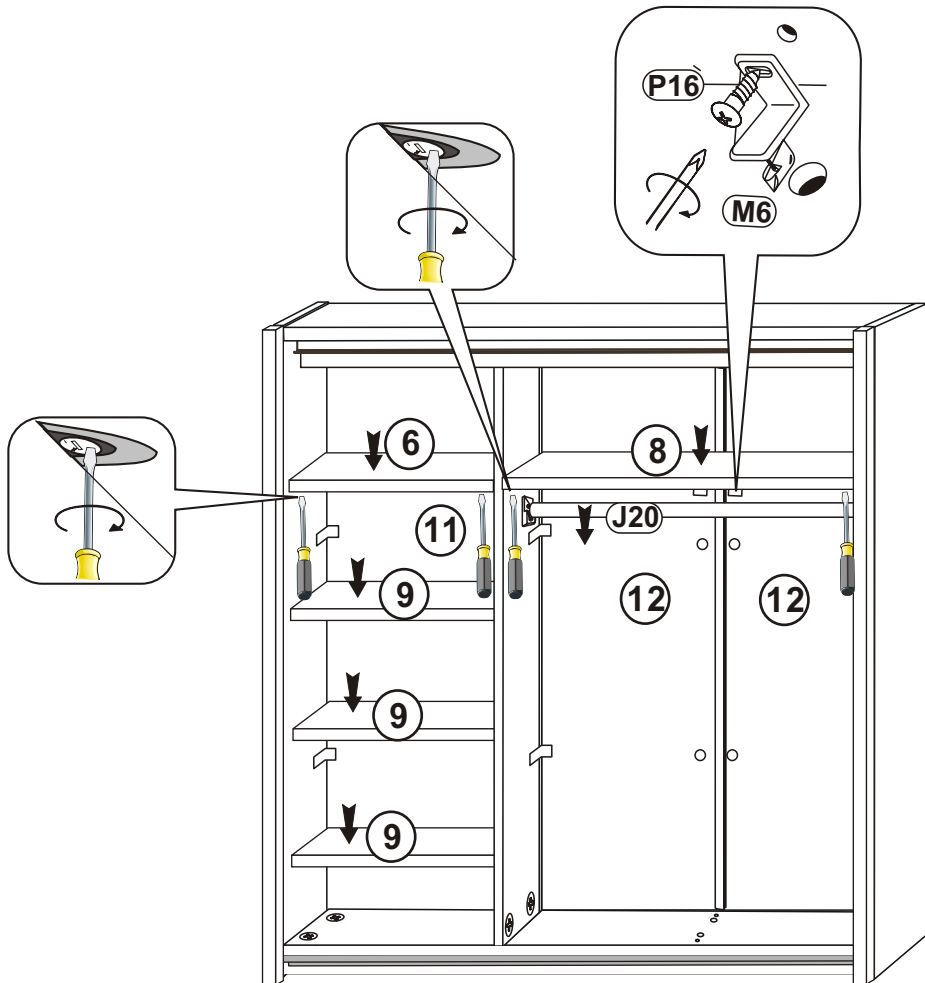
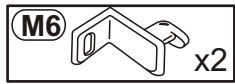
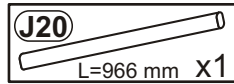

6

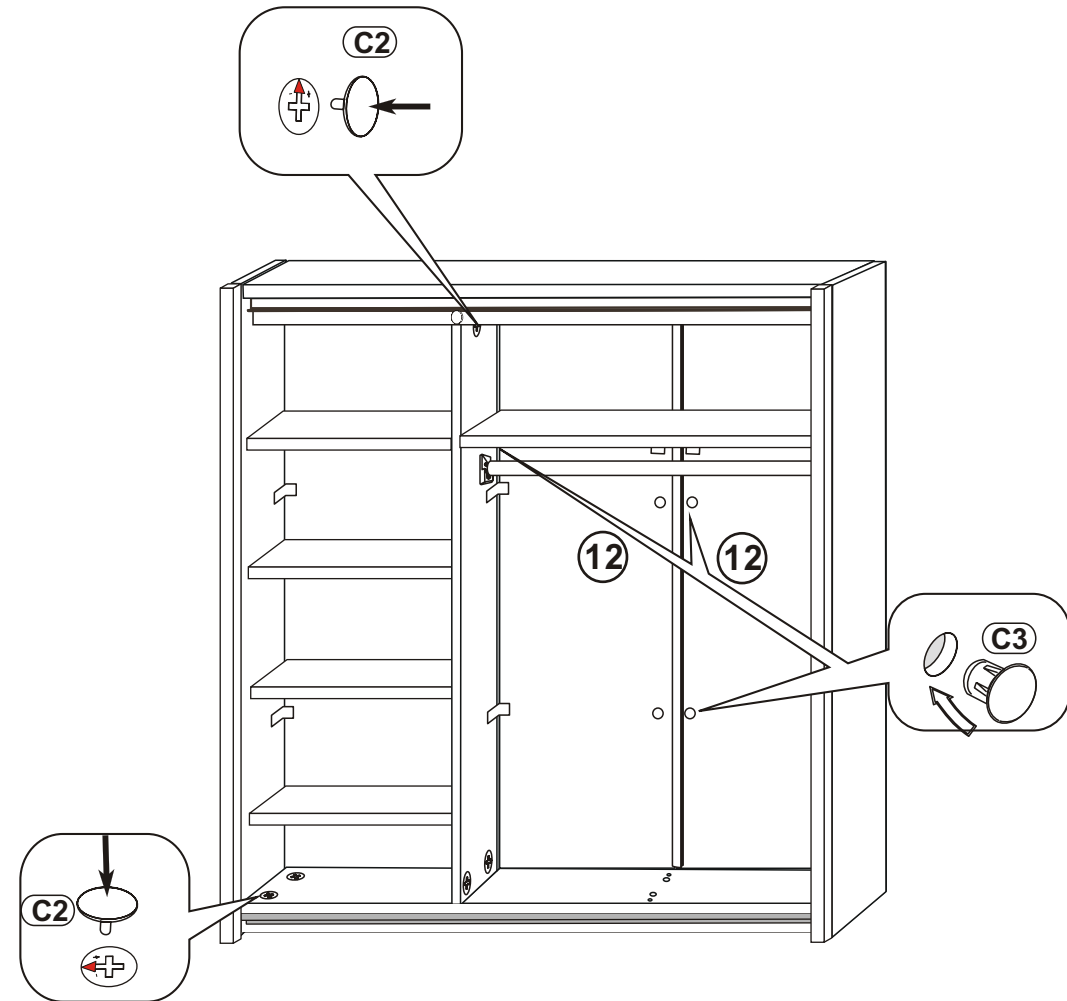
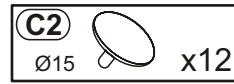

7

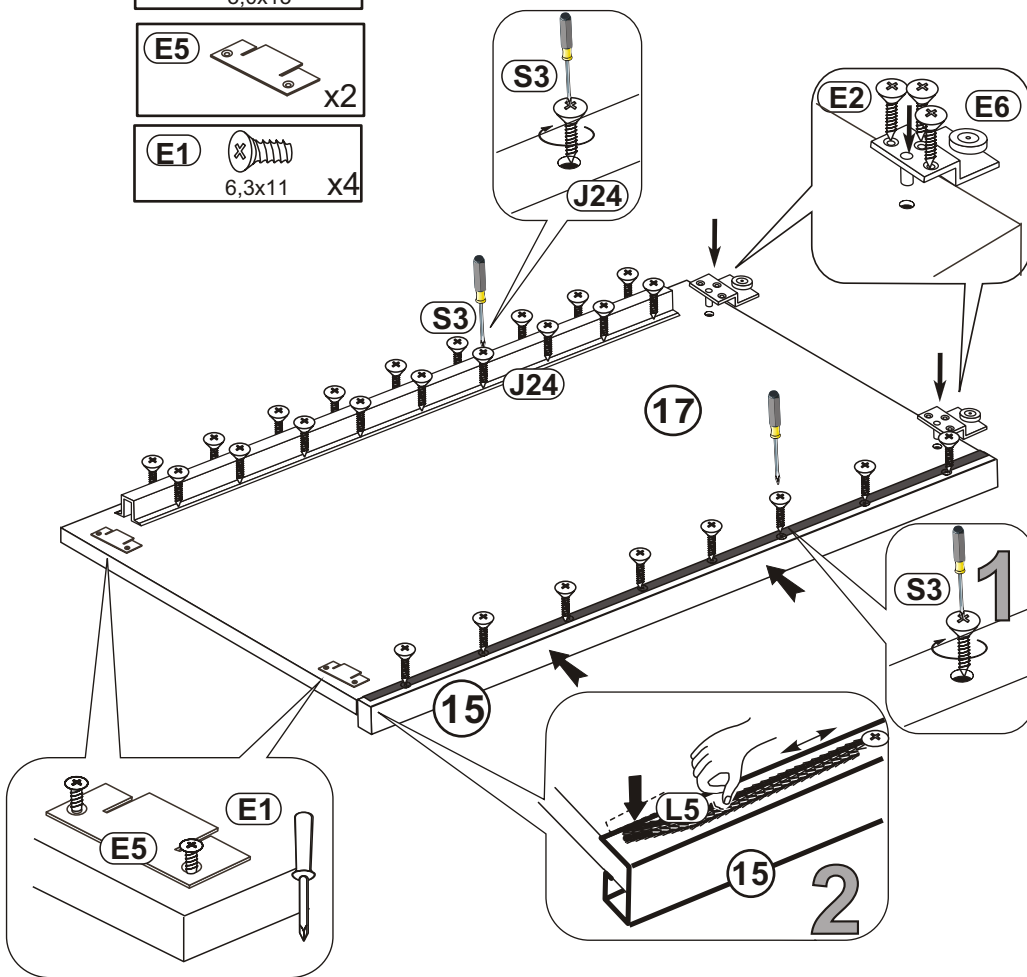
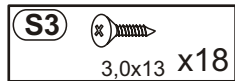
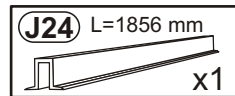
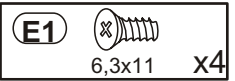
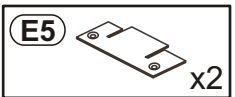
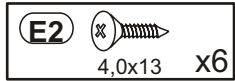
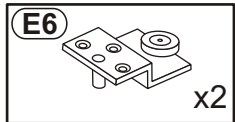

8

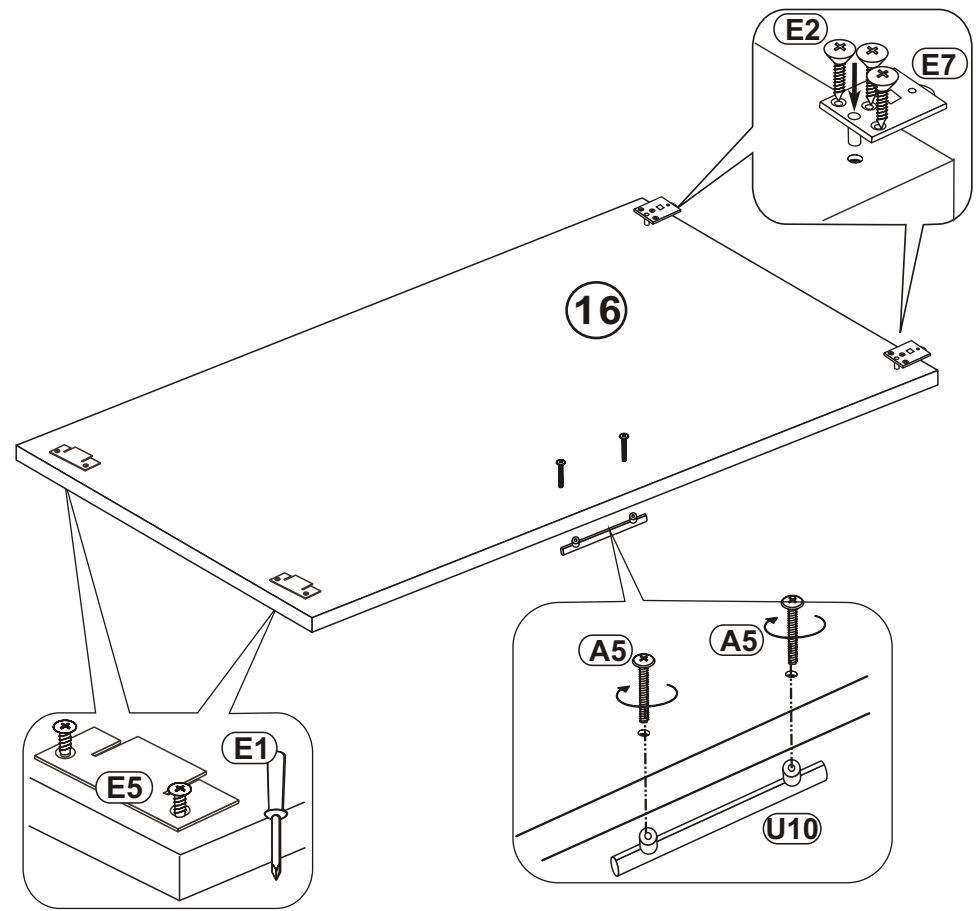
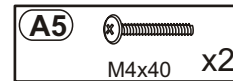
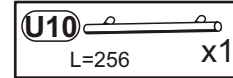
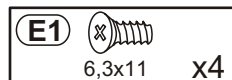
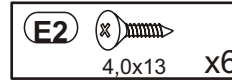
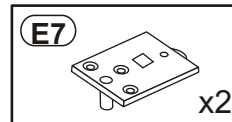

9

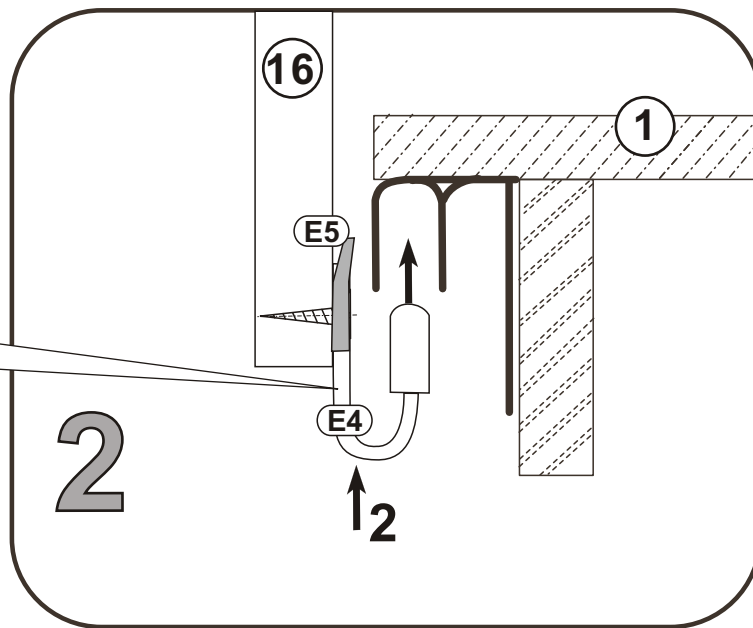
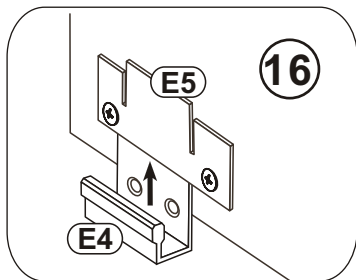
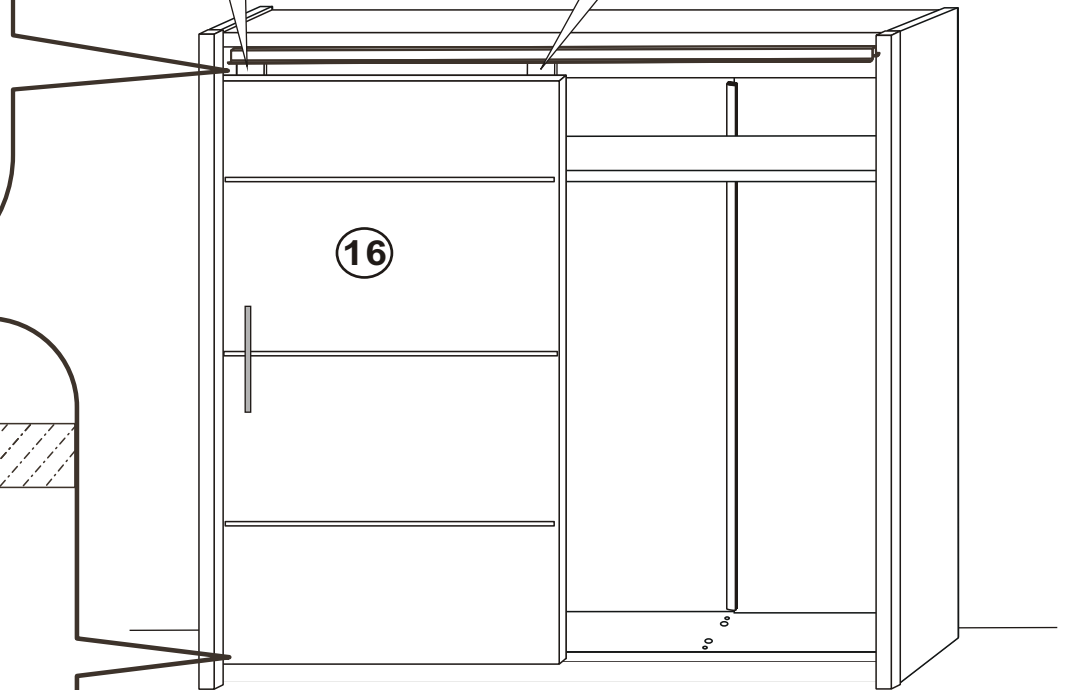
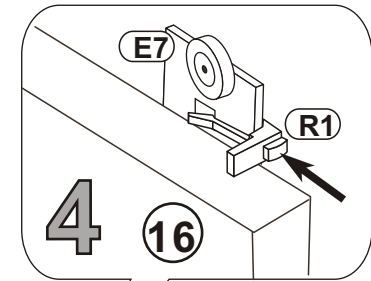
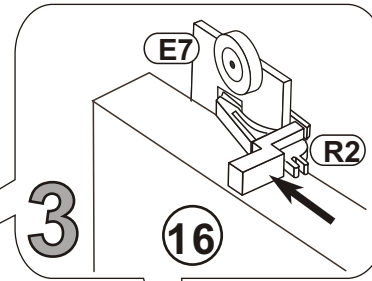
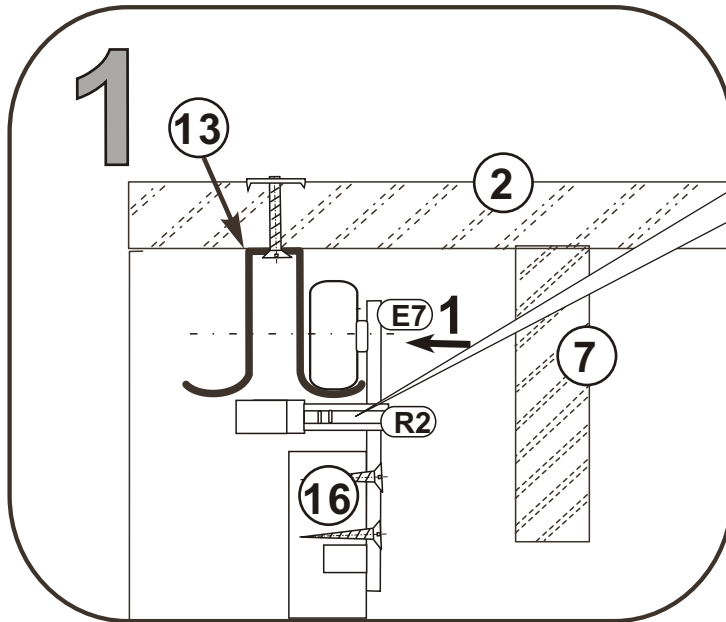
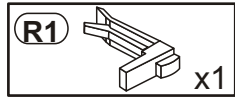
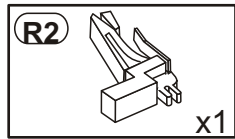
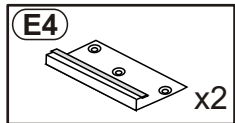

10

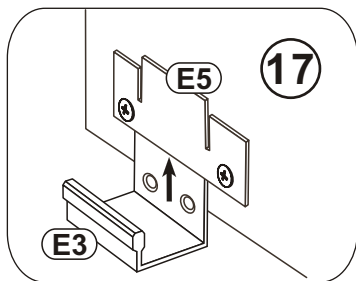
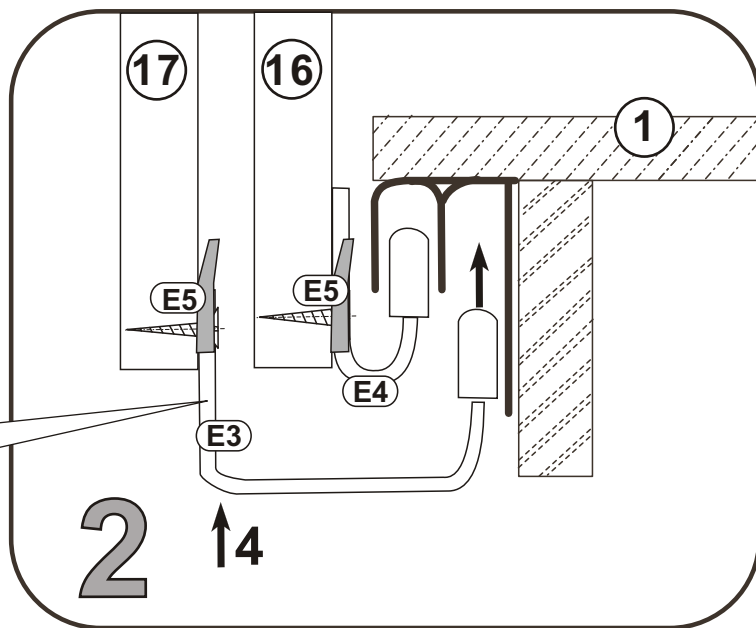
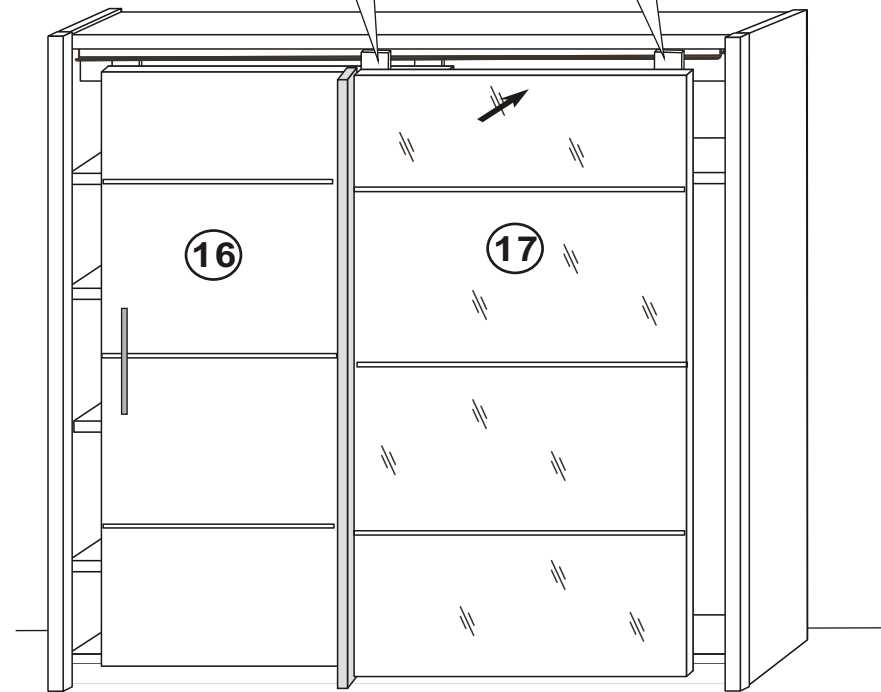
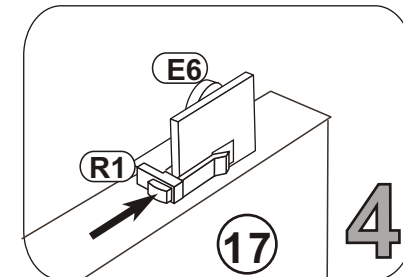
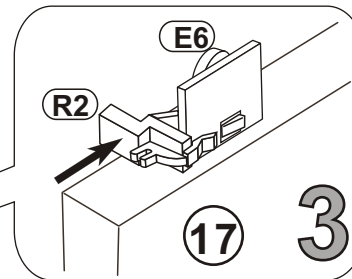
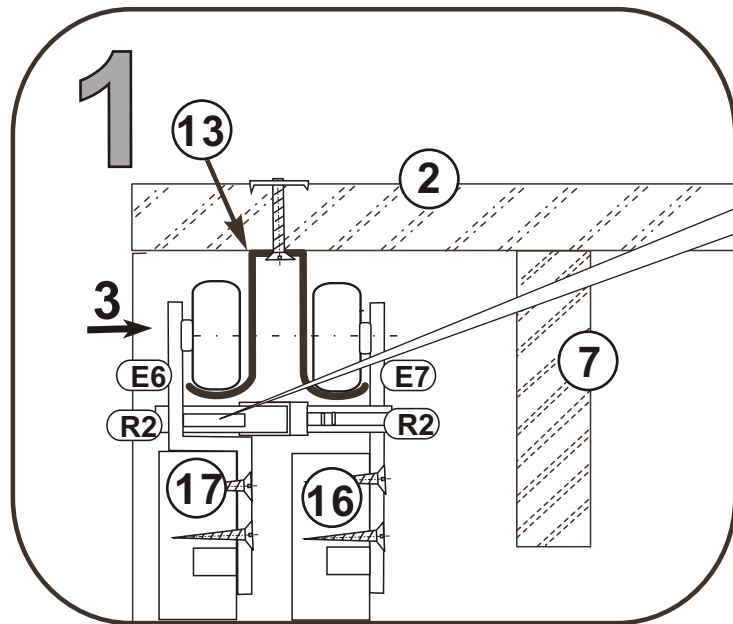
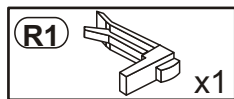
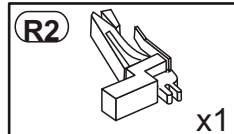
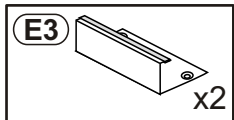

11

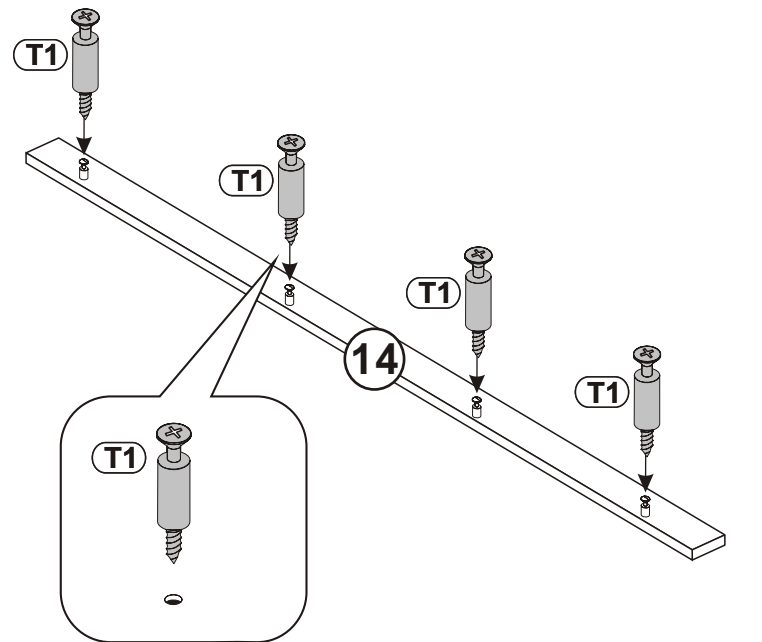

12

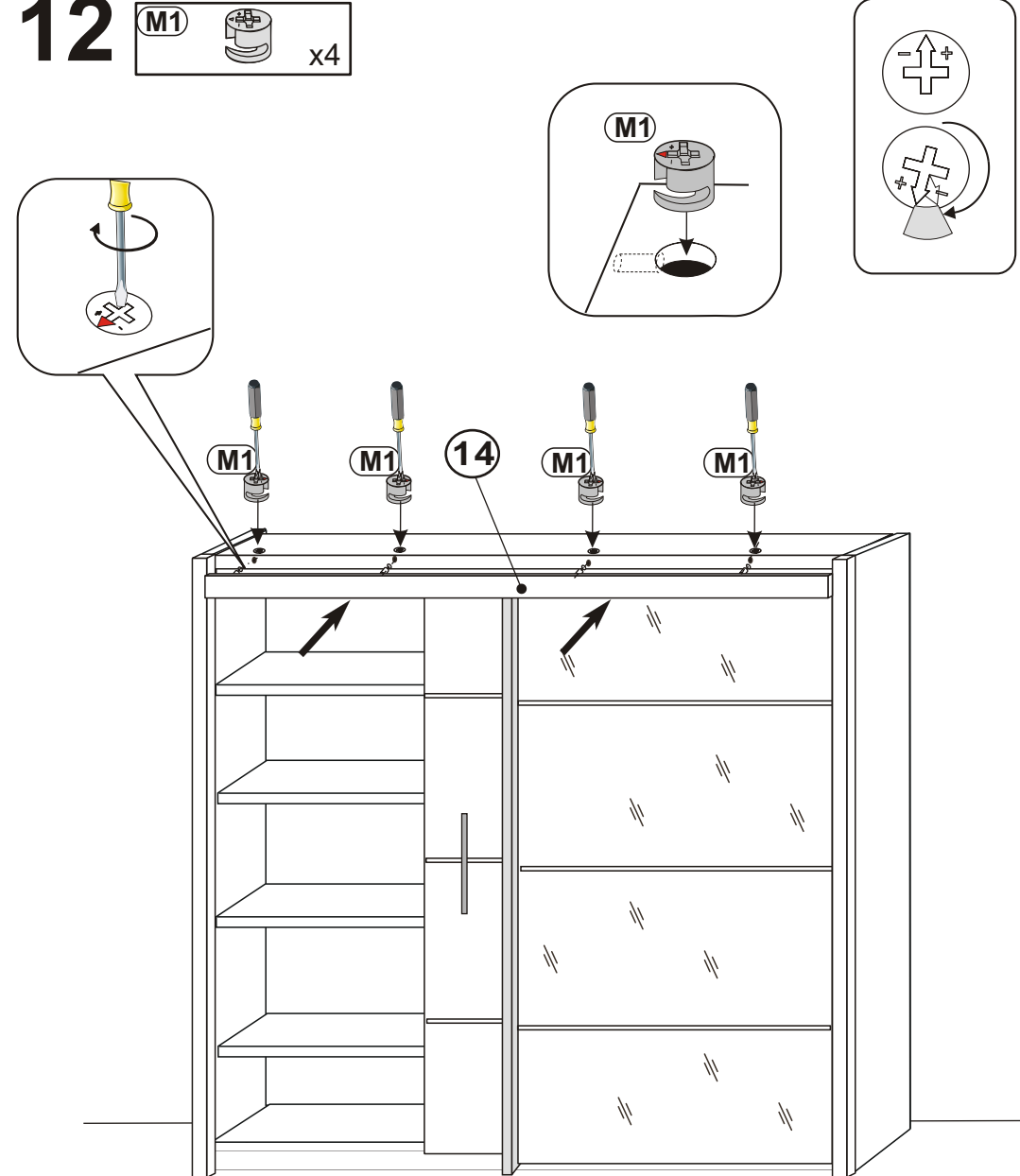

13

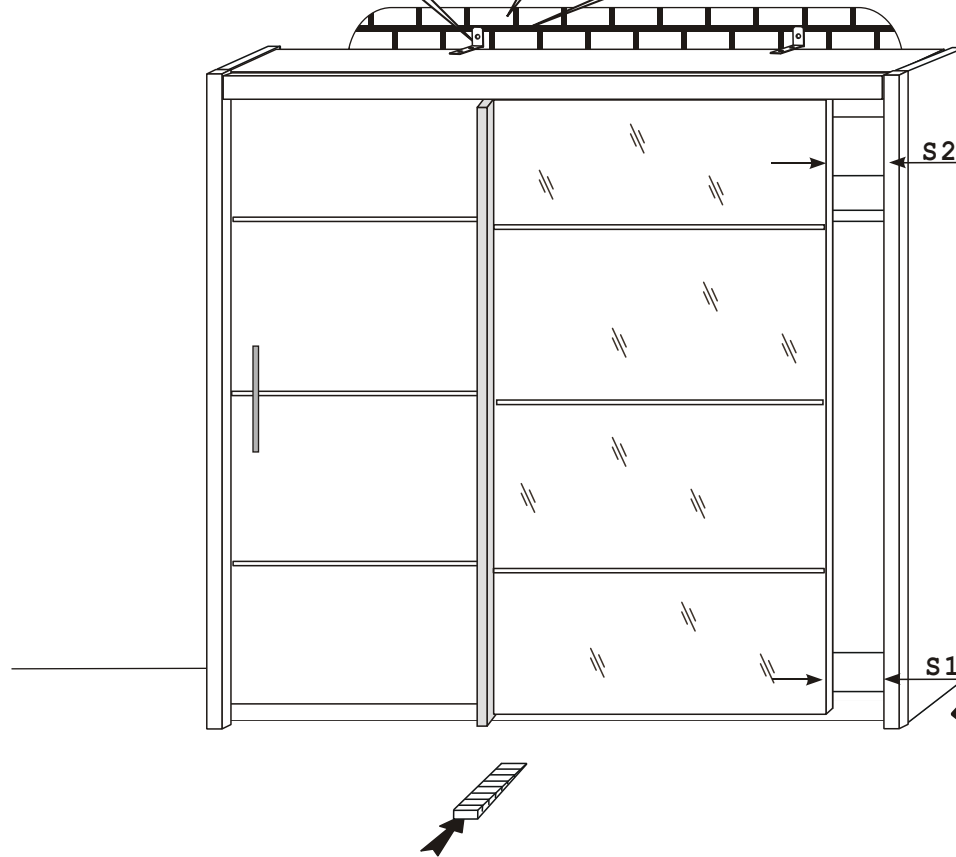
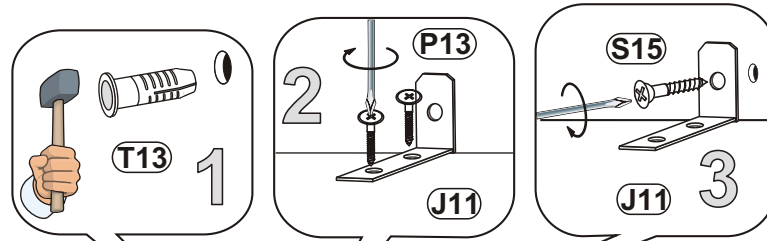

- (PL)** Załączone kołki do zawieszania bryty, do stosowania wyłącznie do ścian betonowych, do innych ścian należy odpowiednie dokupić.
- (GB)** Attached dowels to hang up unit are for concrete walls only. For other types of walls, appropriate dowels must be purchased
- (D)** Die beigelegten Dübel zum Aufhängen des Elements dürfen nur bei Betonwänden eingesetzt werden, bei anderen Wandarten müssen entsprechende Dübel zugekauft werden.
- (F)** Les chevilles jointes, pour pendre l'élément, sont pour les murs bétonnés exclusivement; pour autres murs il faut acheter chevilles adéquates

