

01

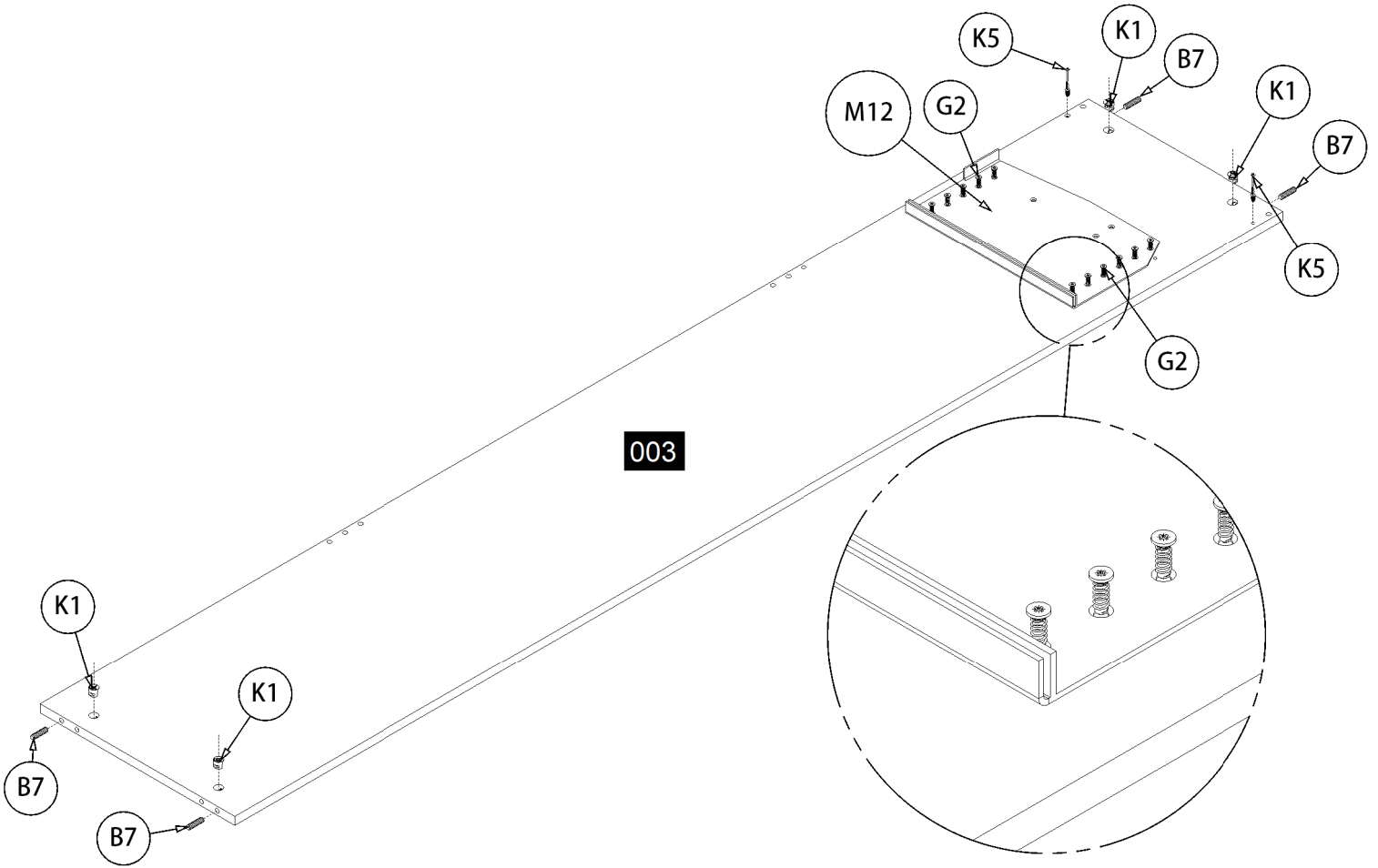

02

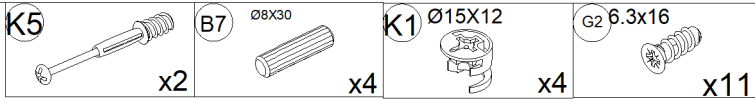
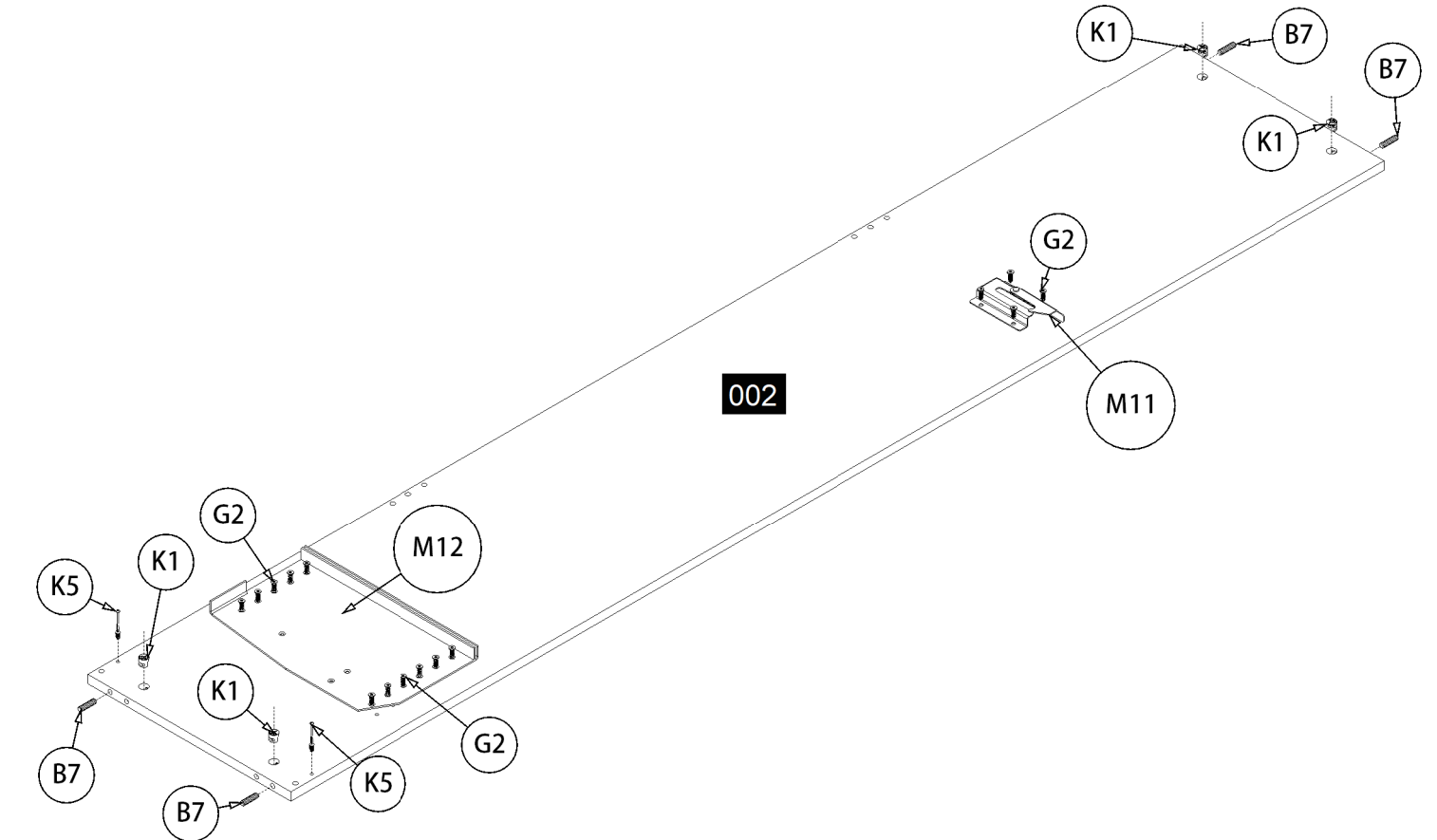
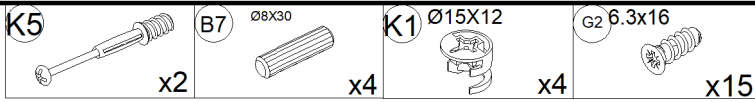

03

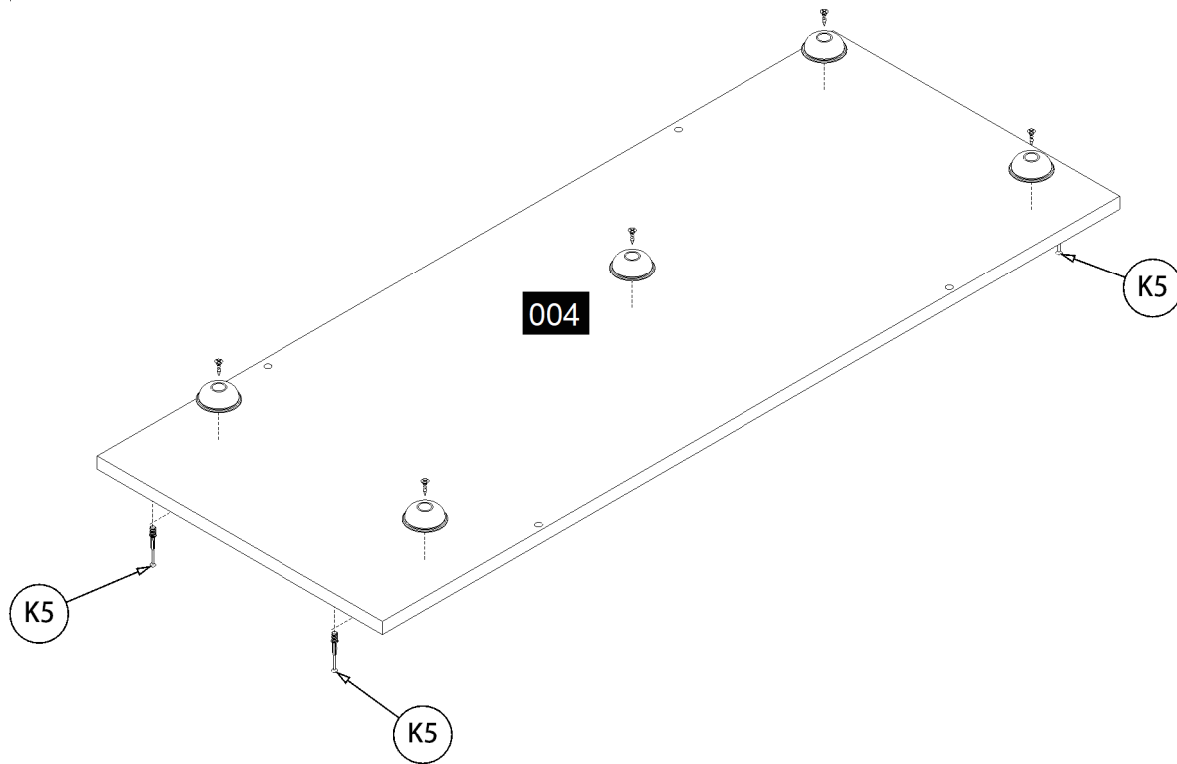
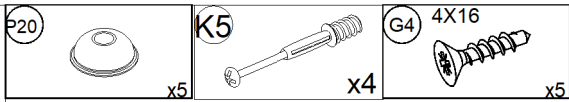

04

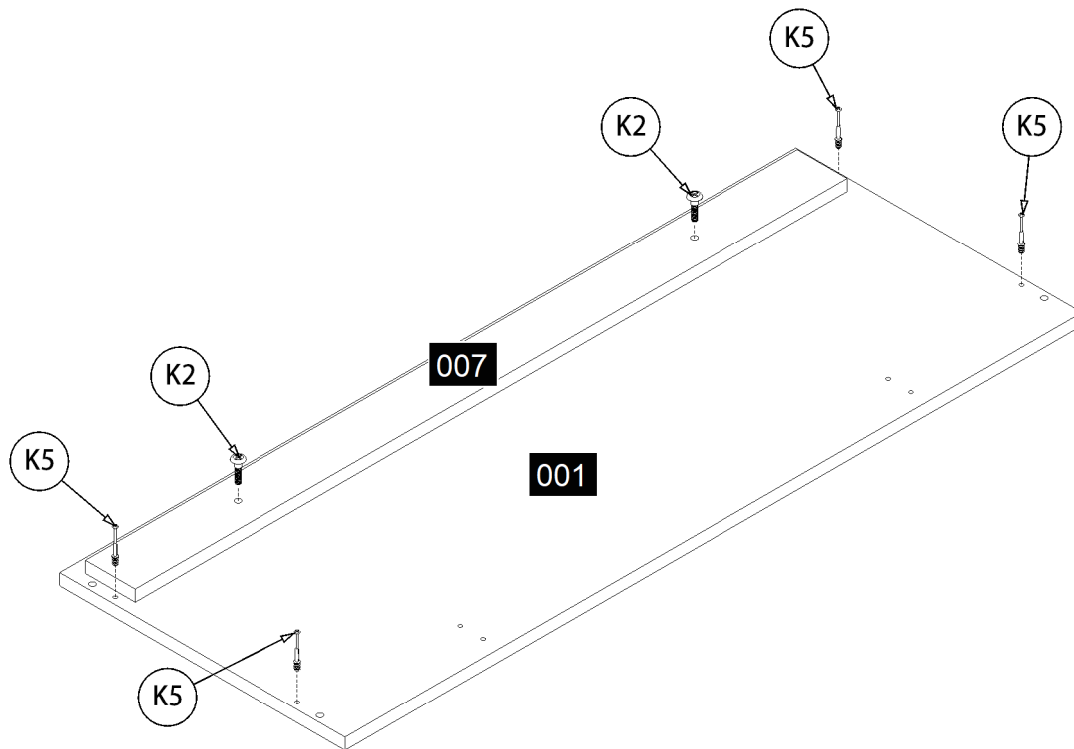
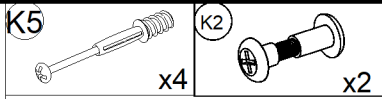

05

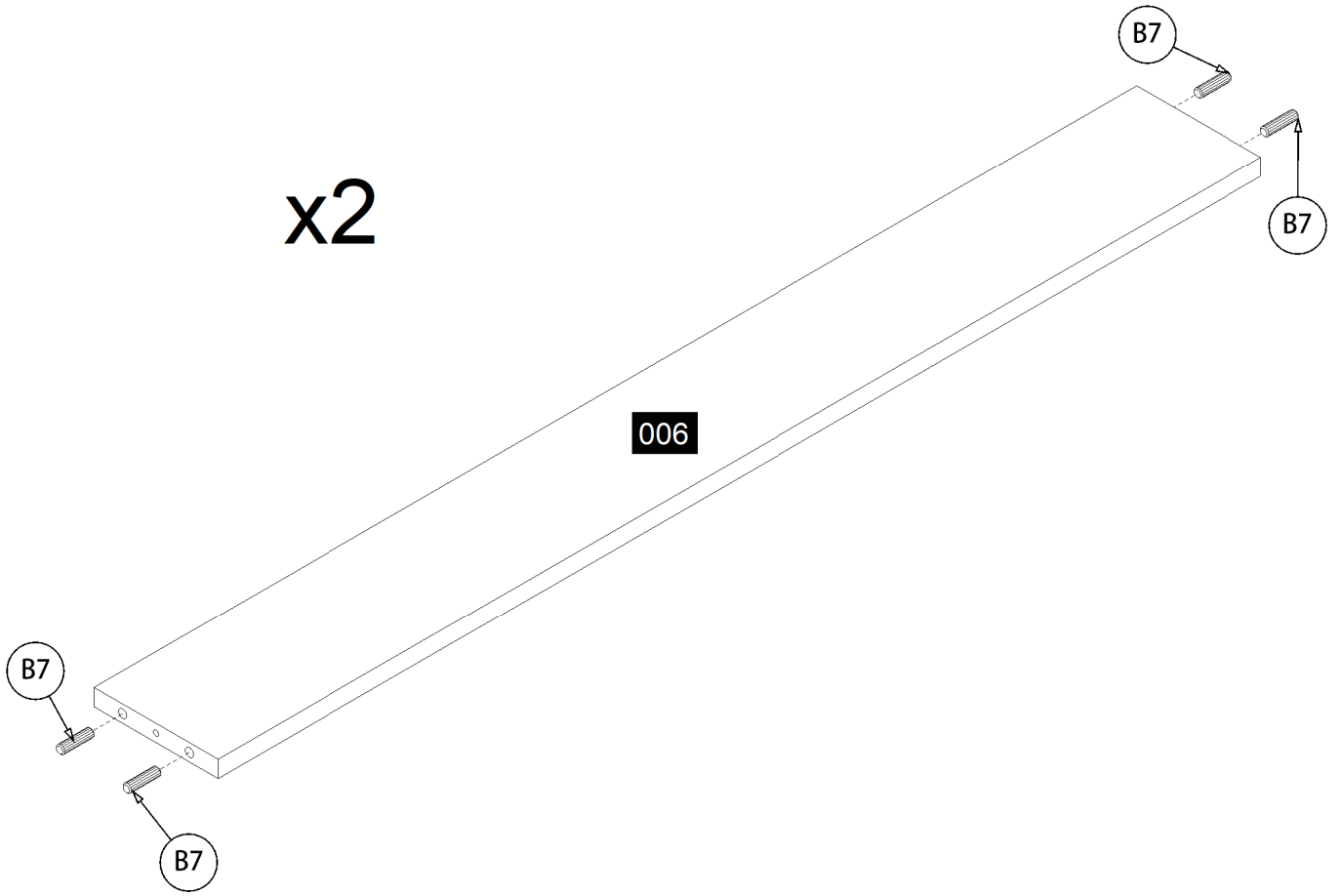
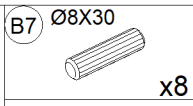

06

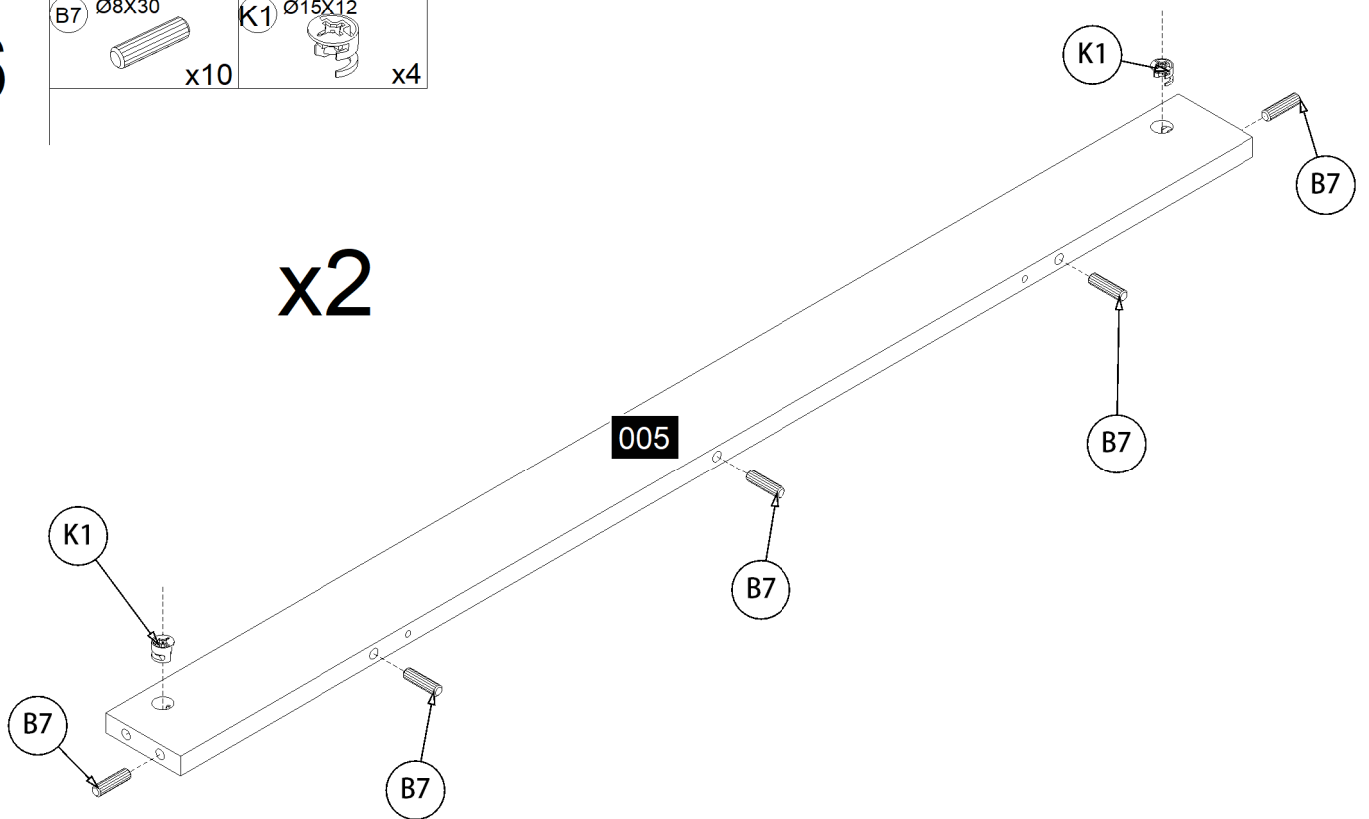
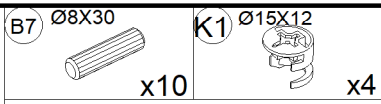

07

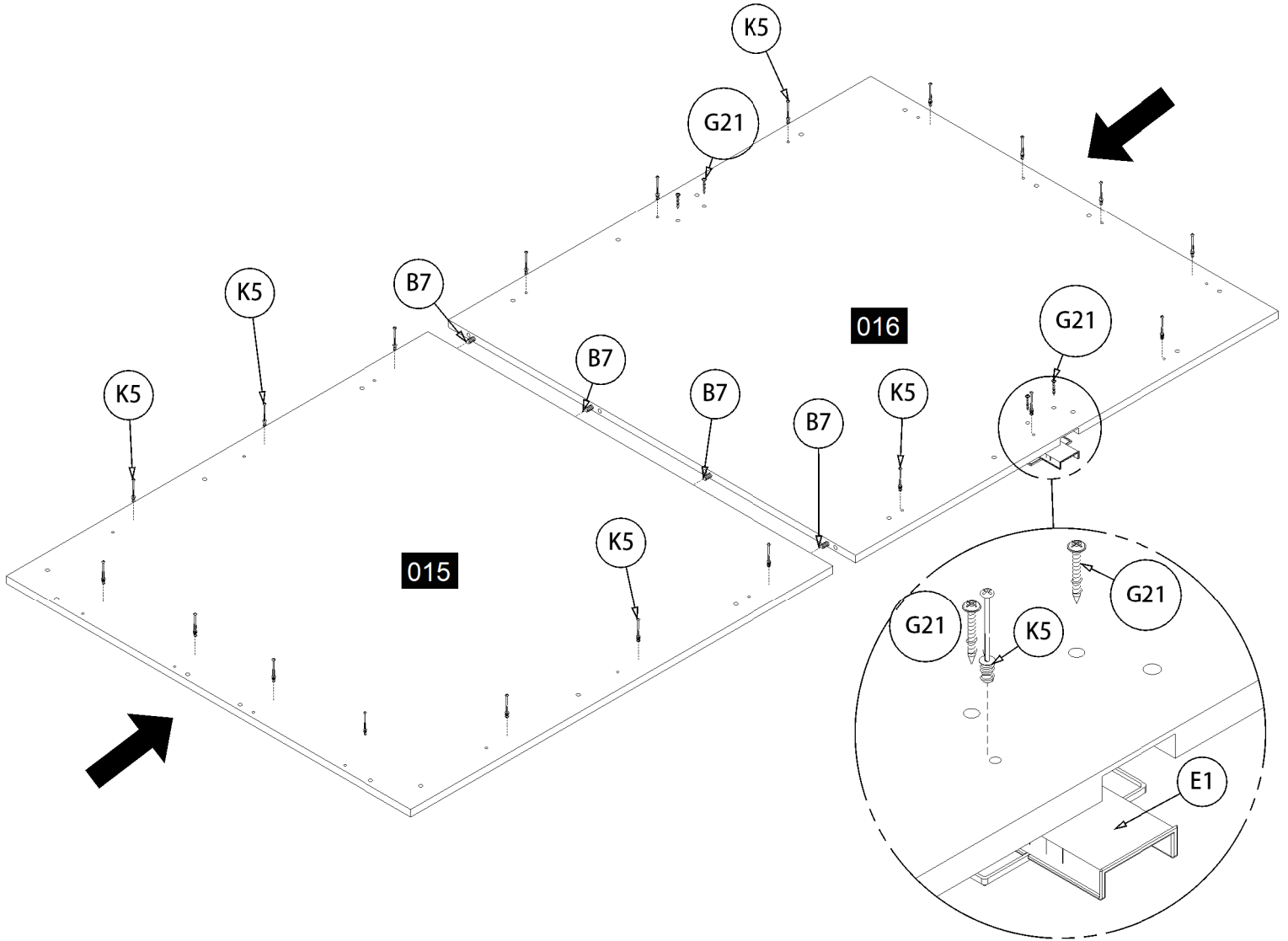
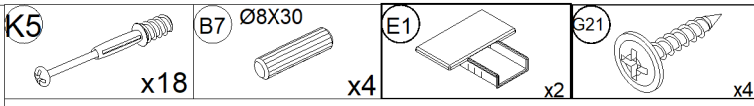

08

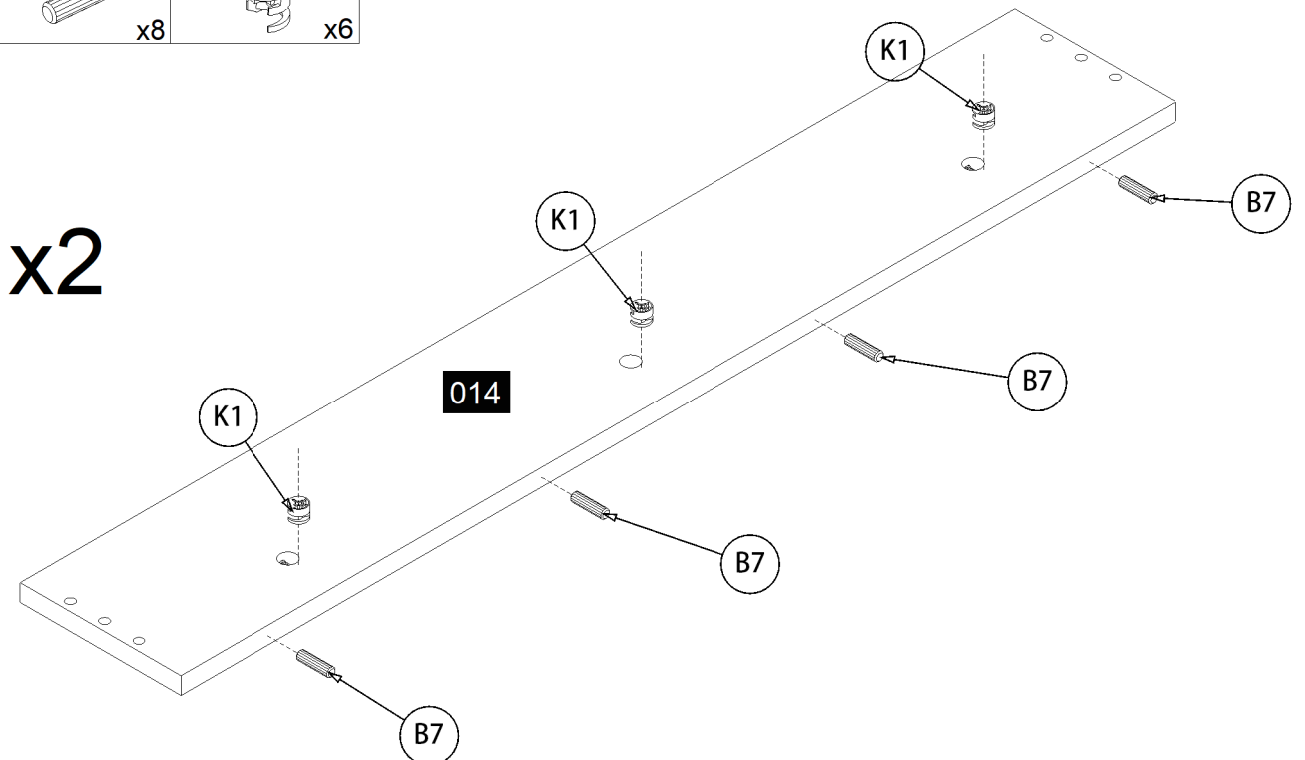
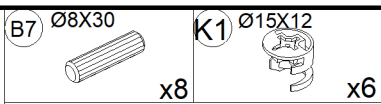

09

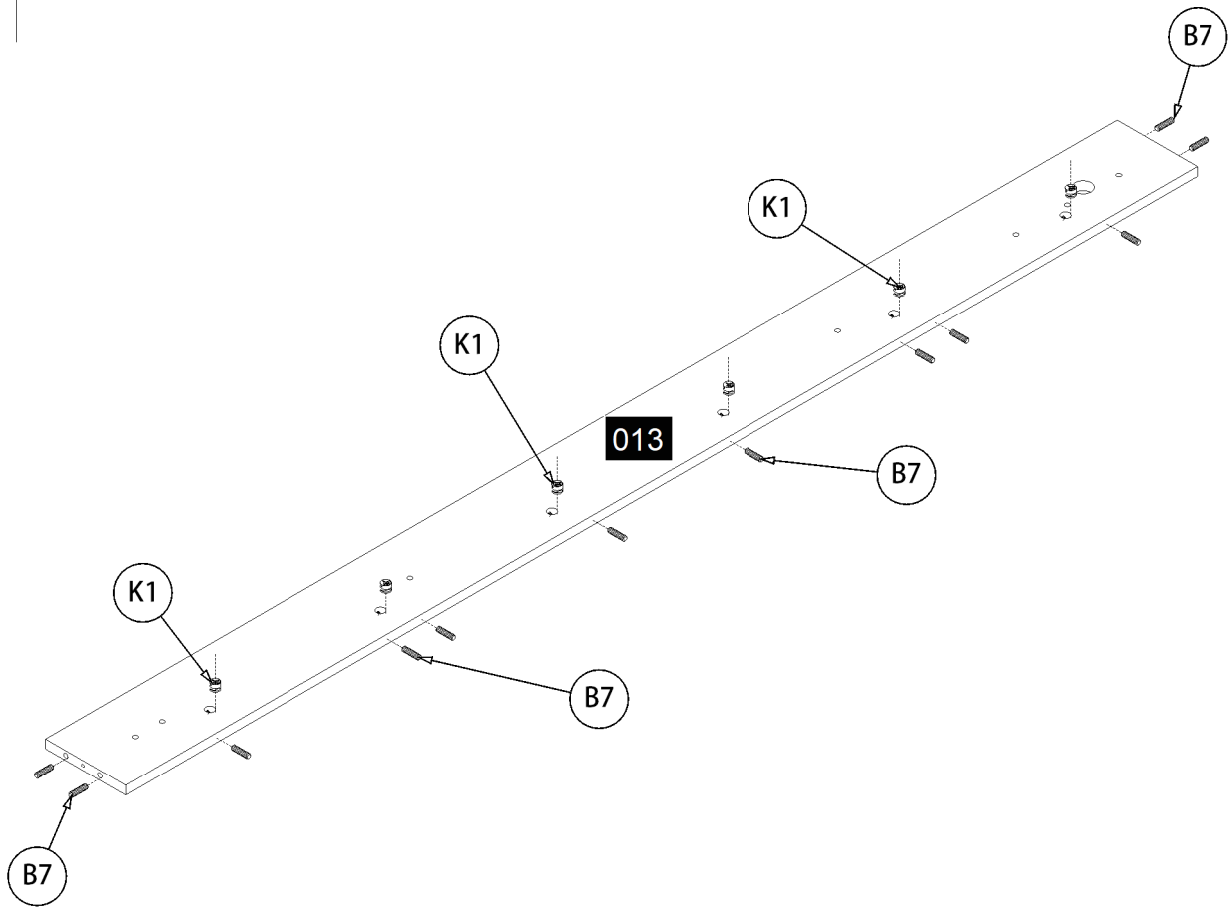
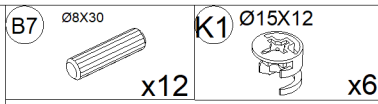

10

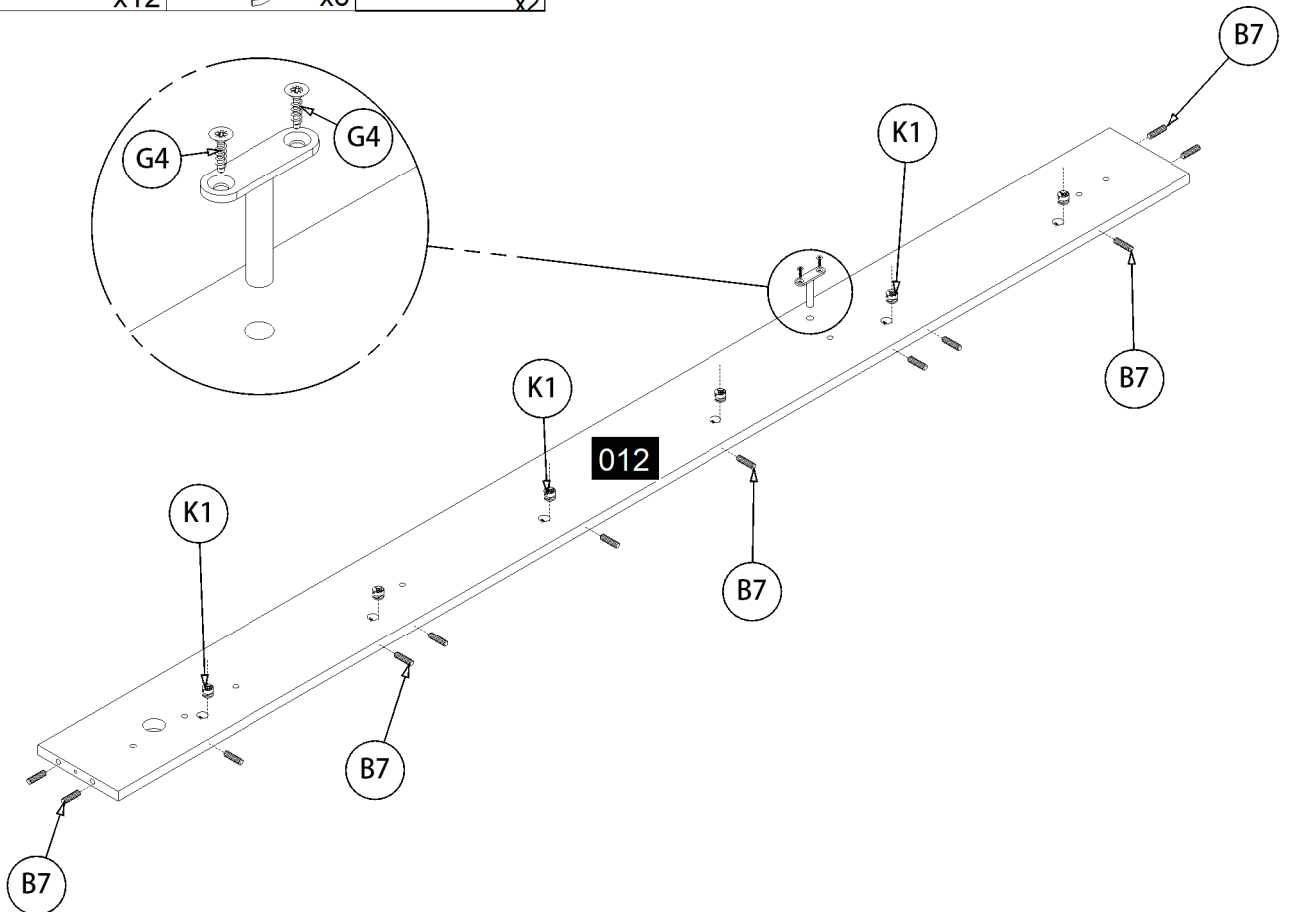
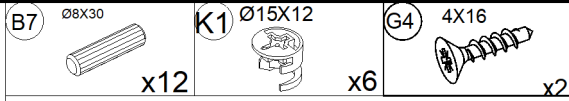

11

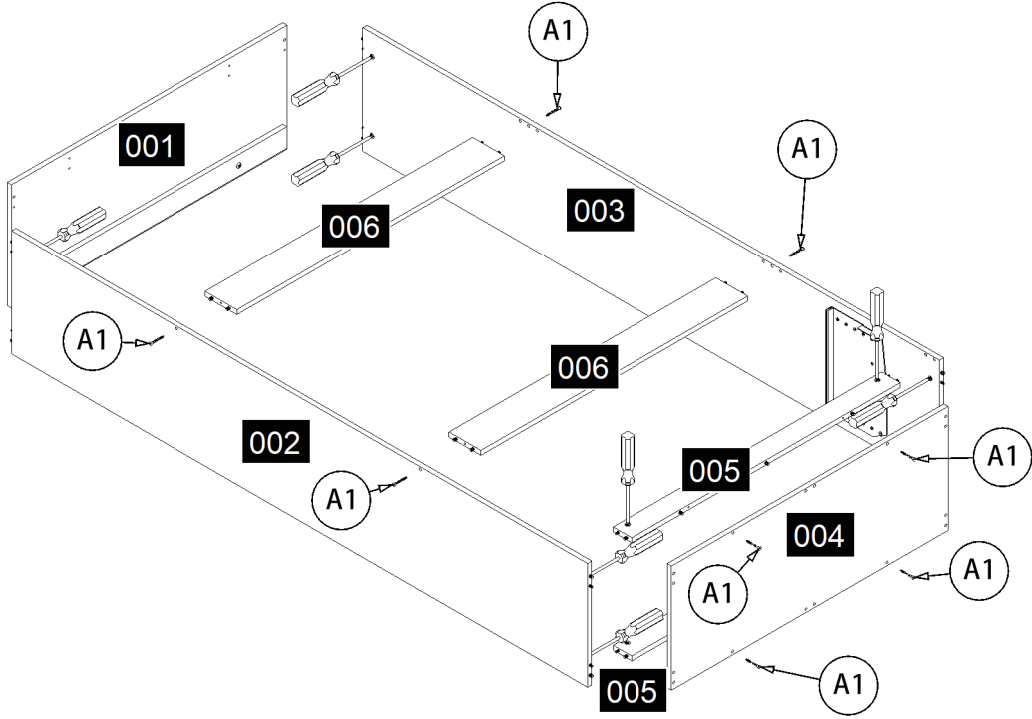
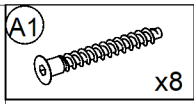

12

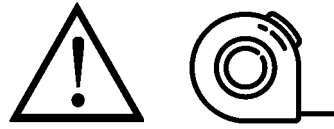
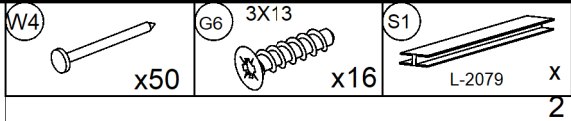

A=B

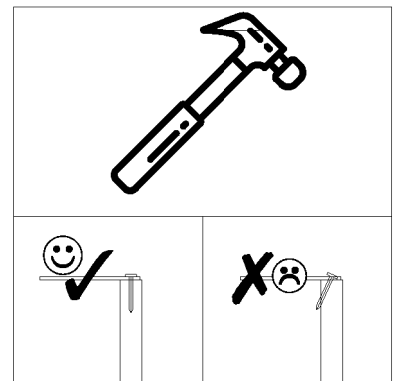
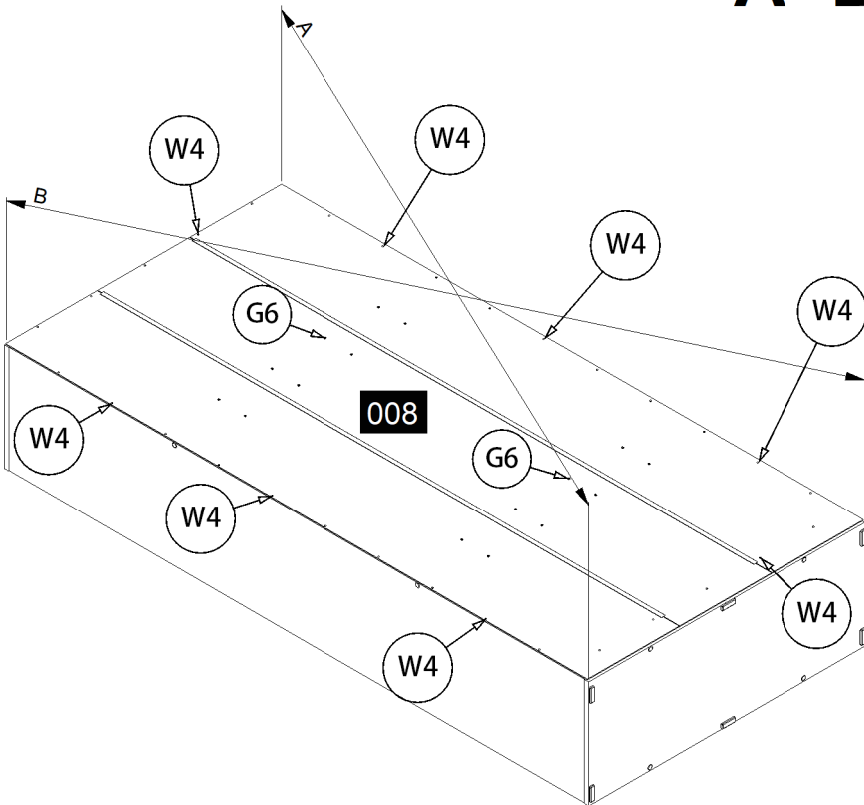
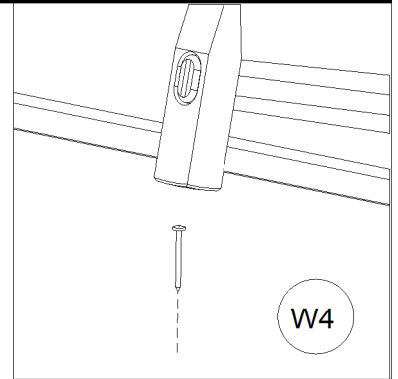

15

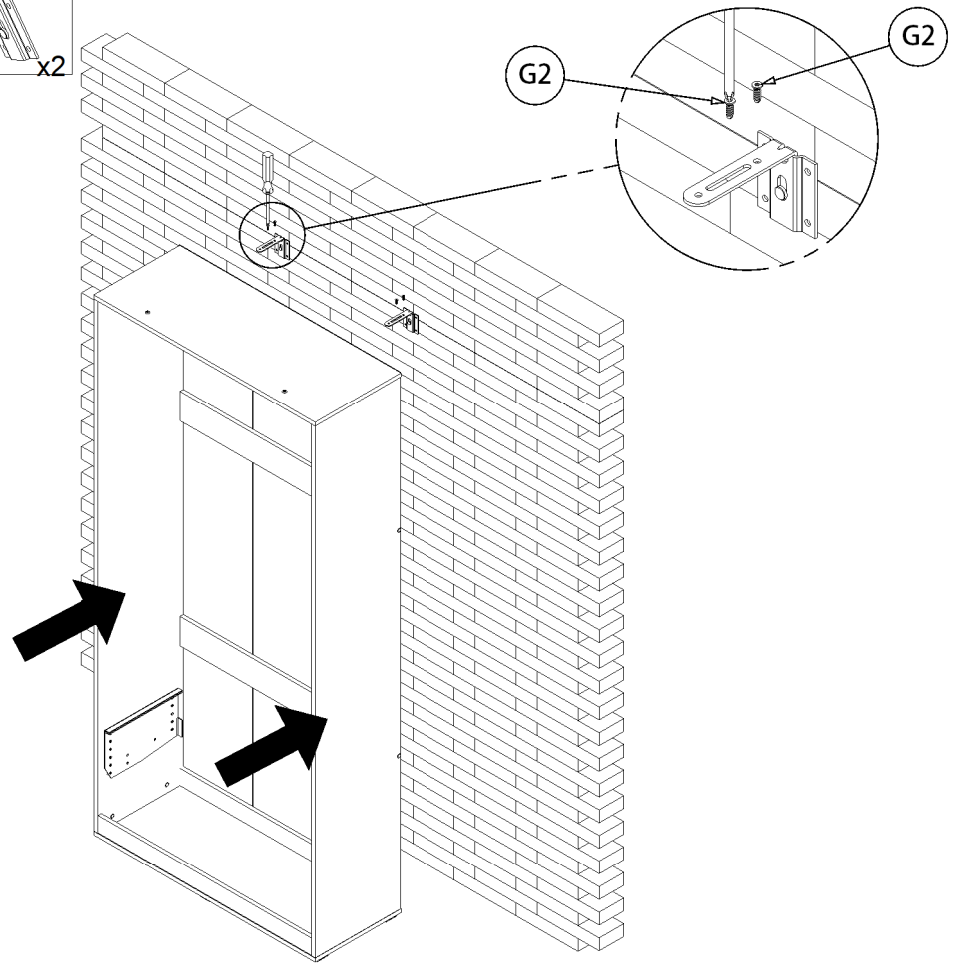
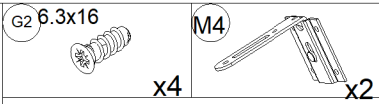

16

