

PRZED ROZPOCZĘCIEM MONTAŻU ZAPOZNAĆ SIĘ Z INSTRUKCJĄ

GRANT Szafa ubraniowa

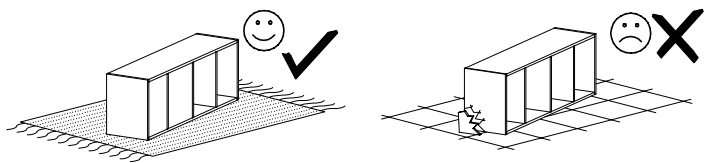

MONTOWAĆ NA MIEKKIM PODŁOŻU TYPU: KOC, DYWAN.

Narzędzia niezbędne do montażu (nie dostarczane przez producenta)

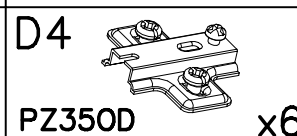
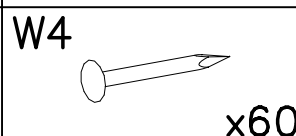
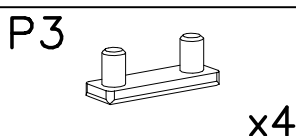
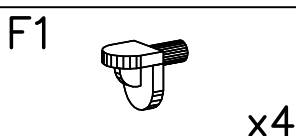
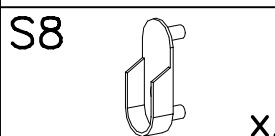
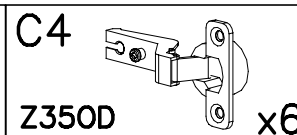
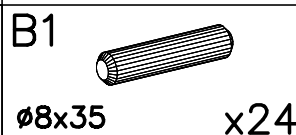
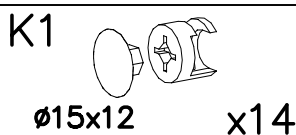
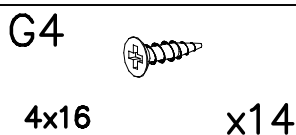
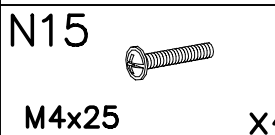
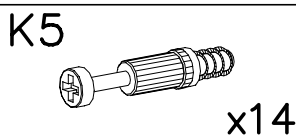
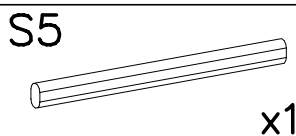
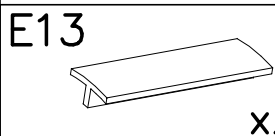
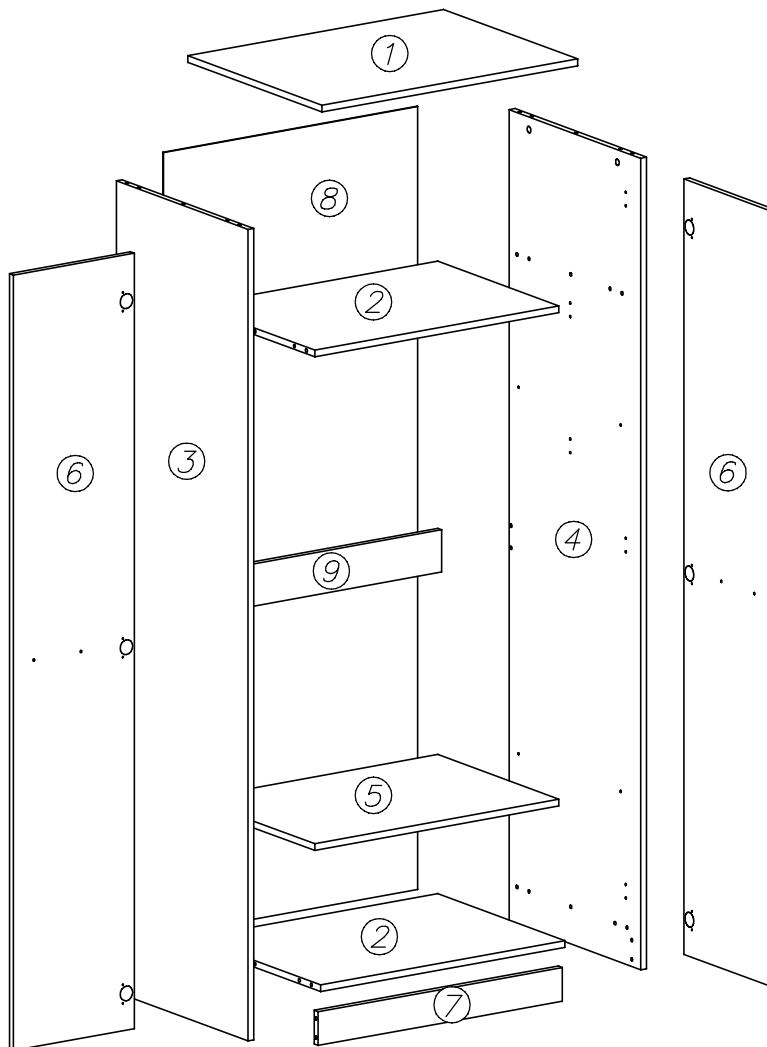
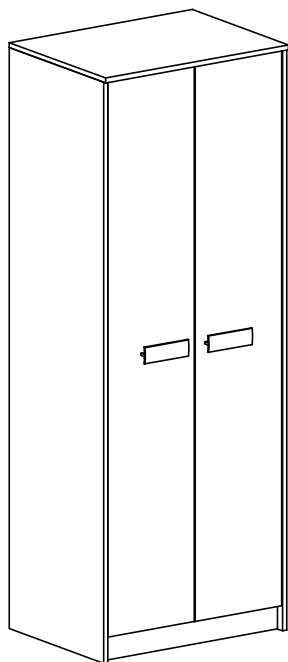
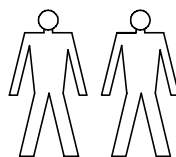
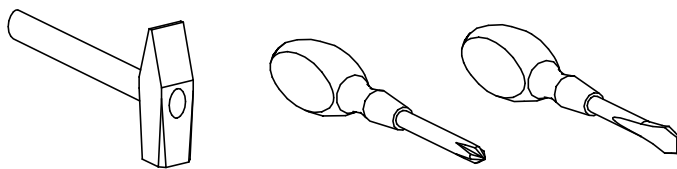

1

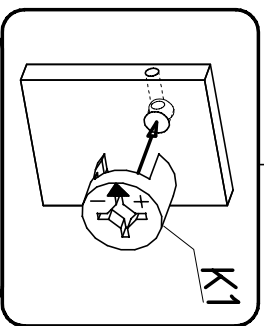
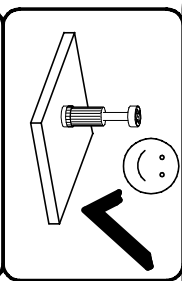
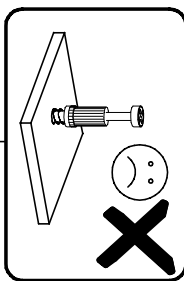
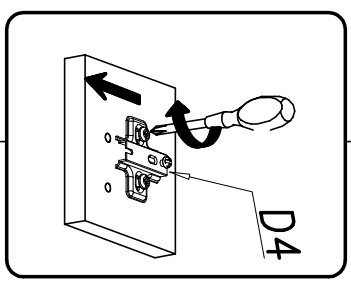
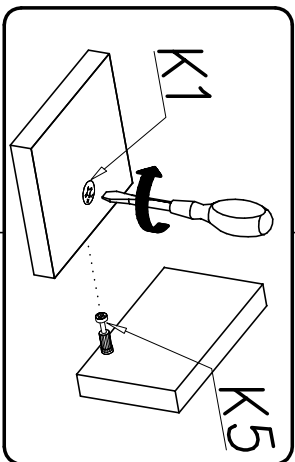
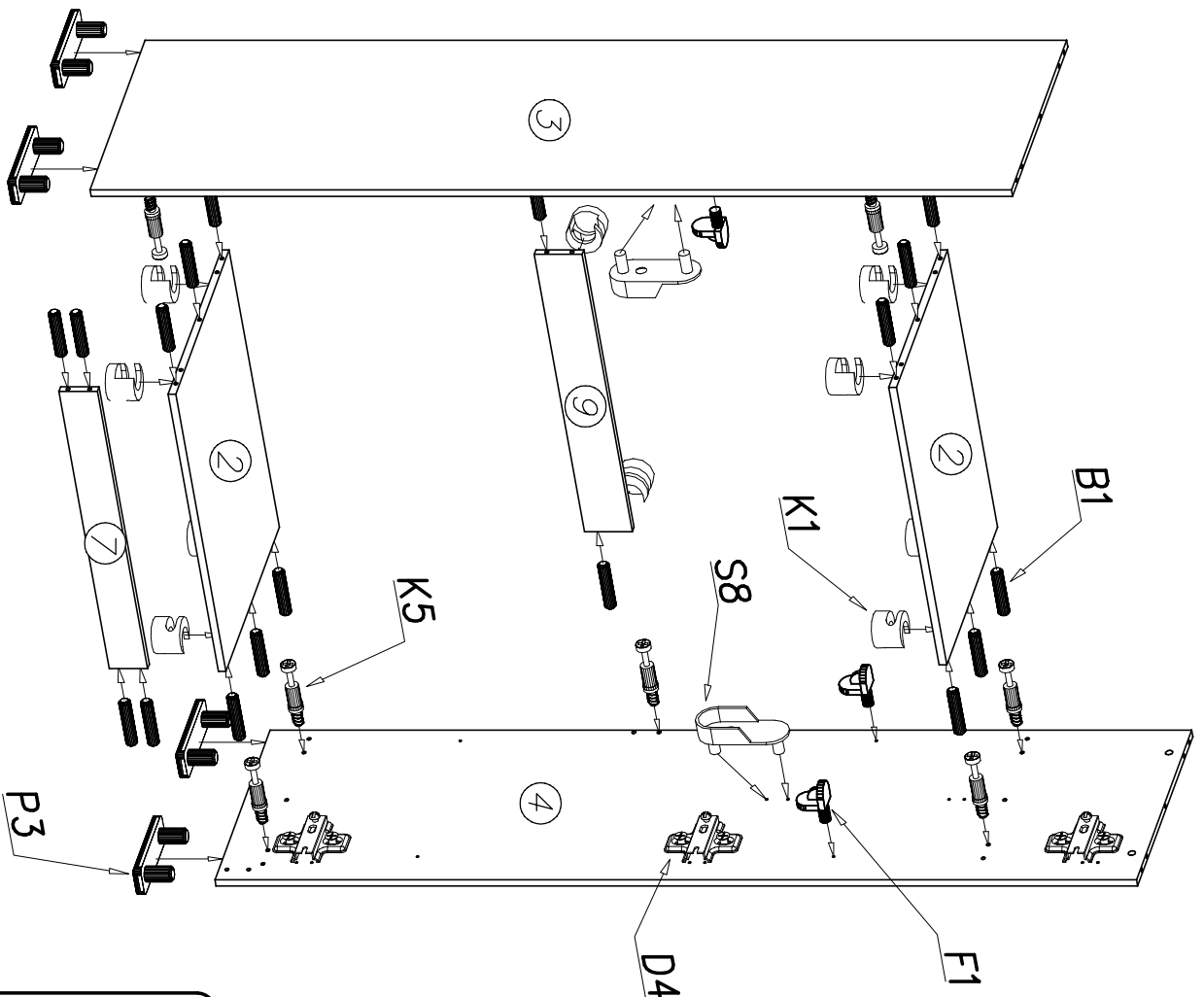

2

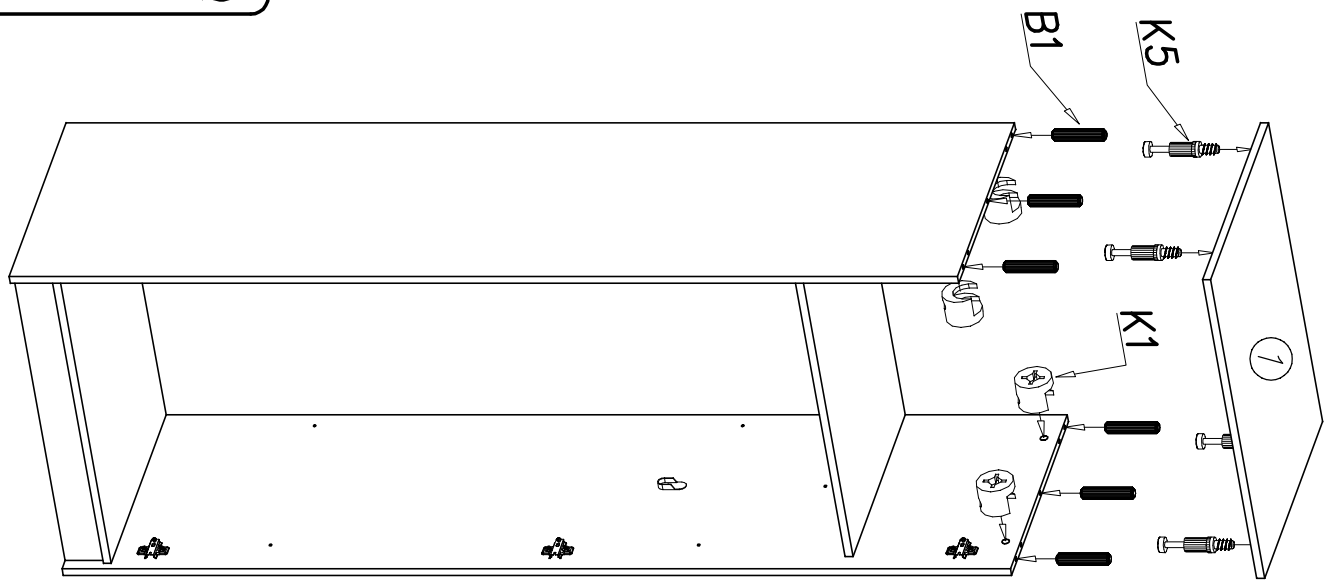

3

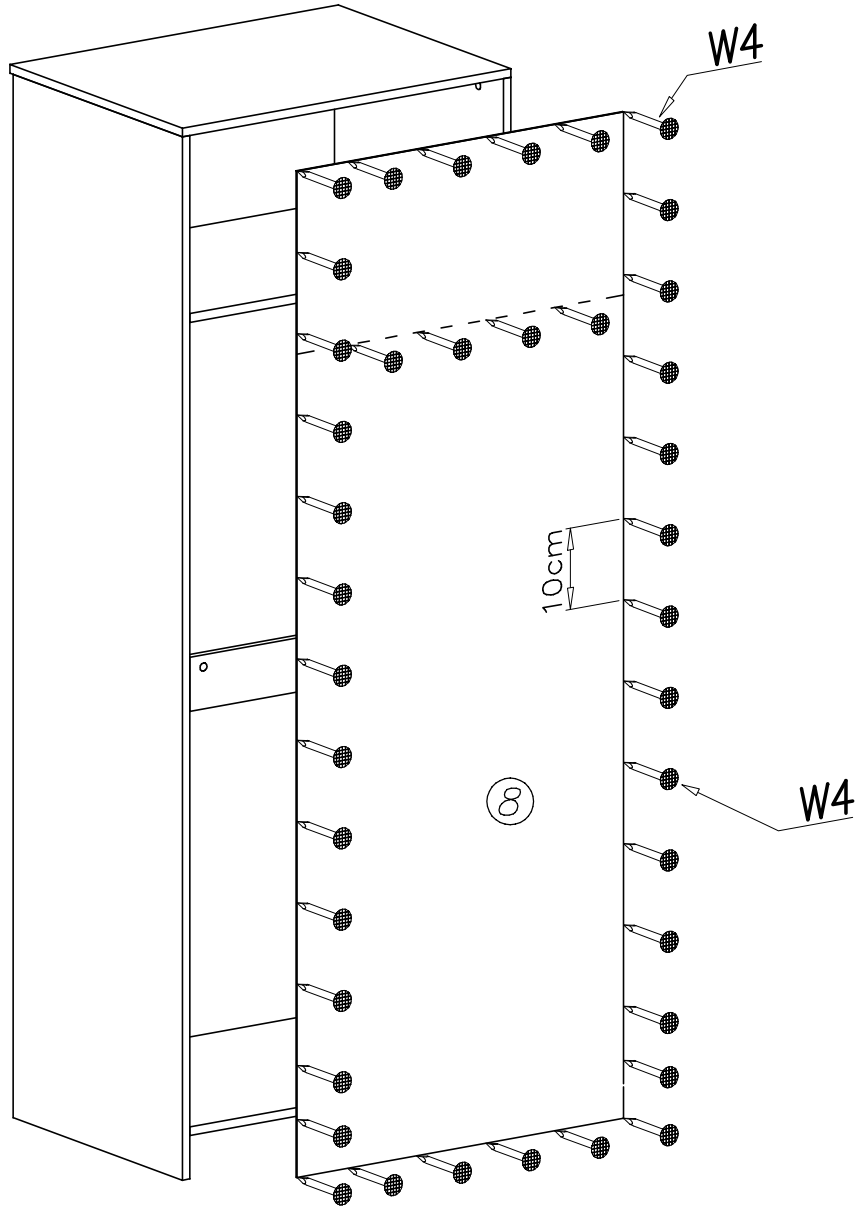

4

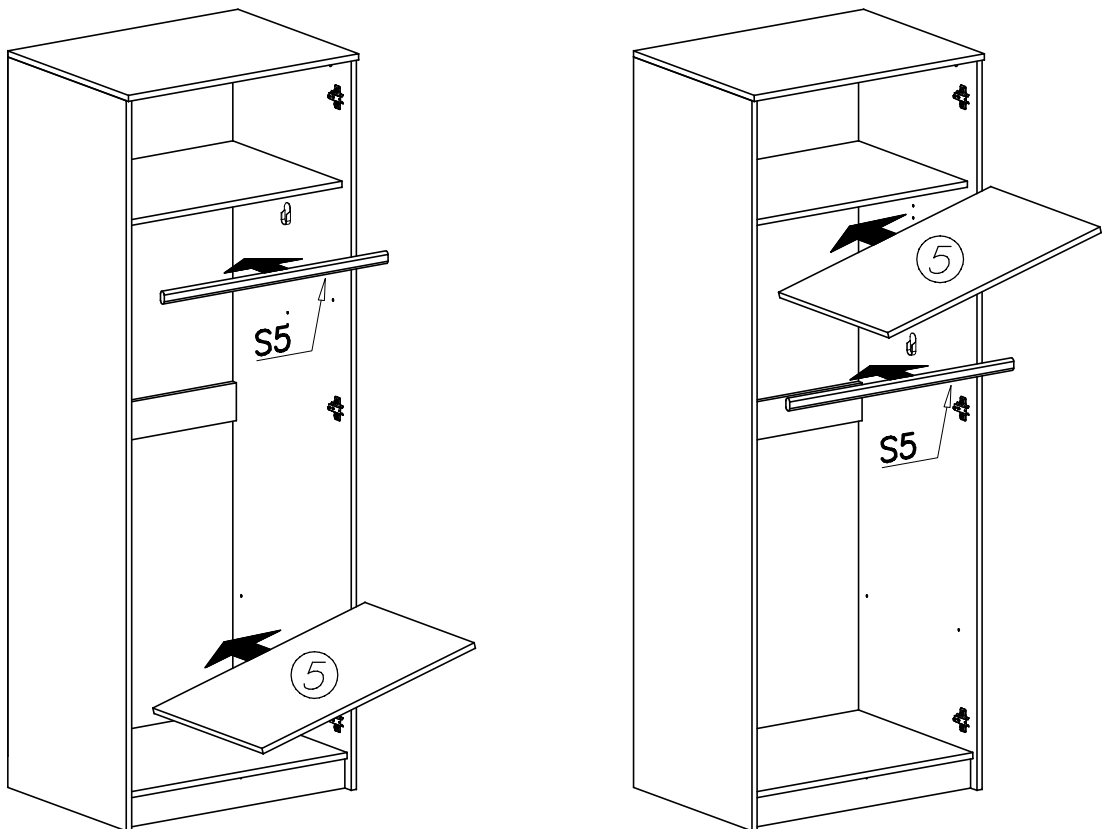

5

