

GRANT 18

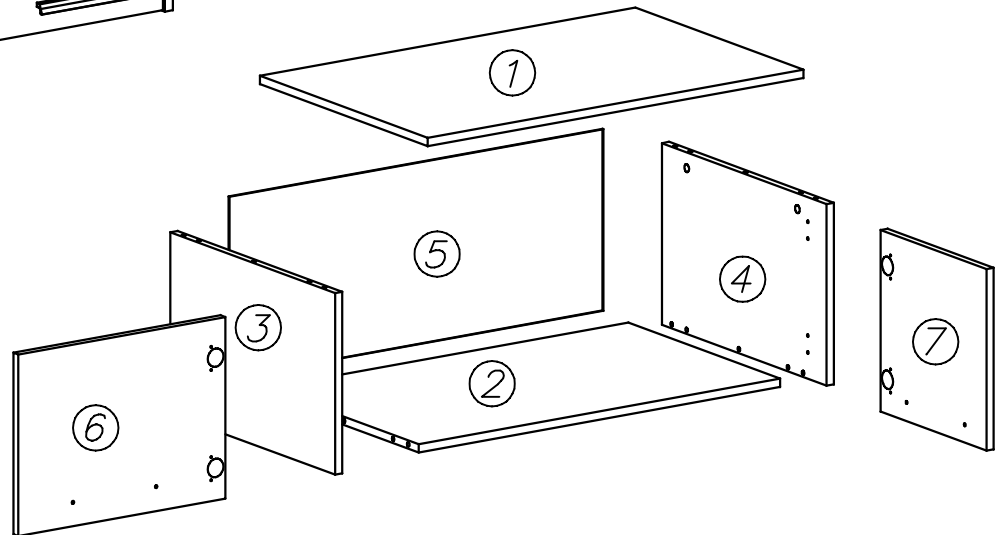

nr	L[mm]	B[mm]	T[mm]	Menge	Coll
1	880	536	16	1	1/1
2	847	504	16	1	1/1
3	384	526	16	1	1/1
4	384	526	16	1	1/1
5	872	393	2,5	1	1/1
6	501	355	16	1	1/1
7	339	355	16	1	1/1

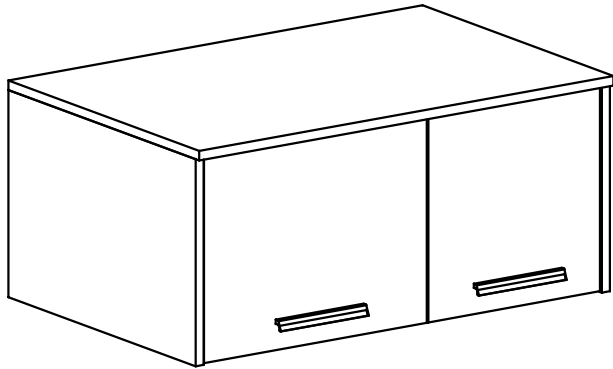
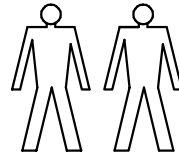
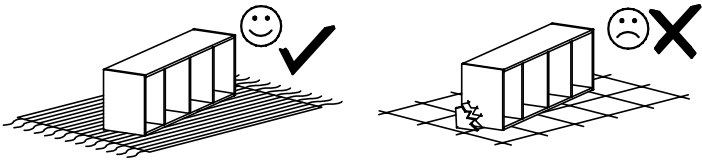
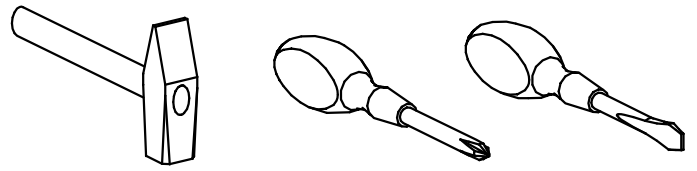
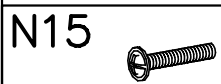

N15
M4x25 x4

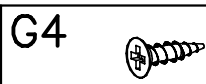

G4
4x16 x8



K1
ø15x12 x8

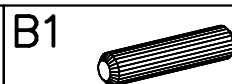

B1
ø8x35 x12

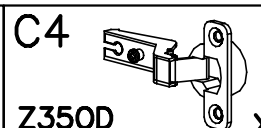

C4
Z350D x4

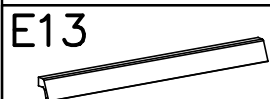

E13
x2

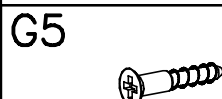

G5
3,5x30 x2

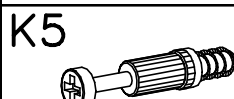

K5
x8

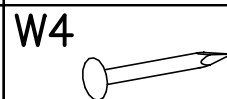

W4
x20

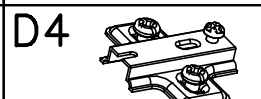

D4
PZ350D x4

1

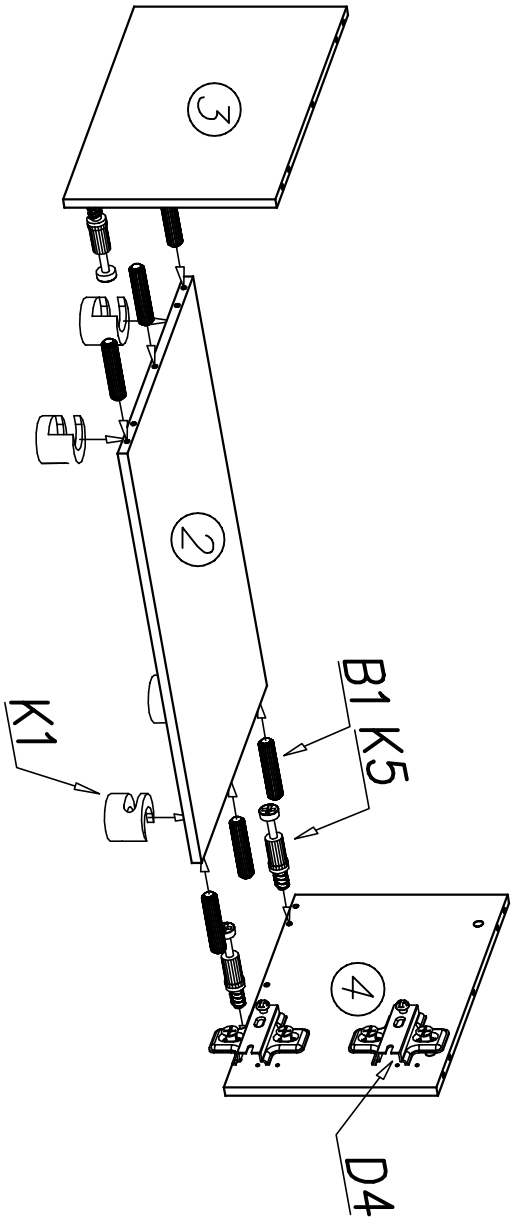

2

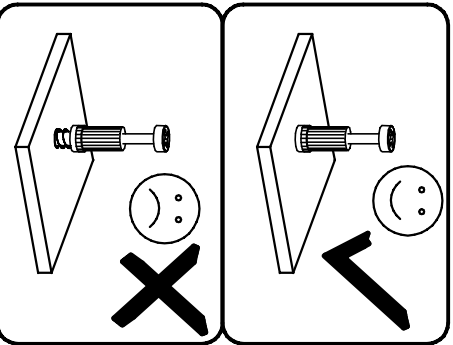
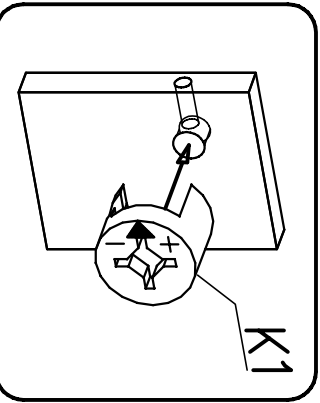
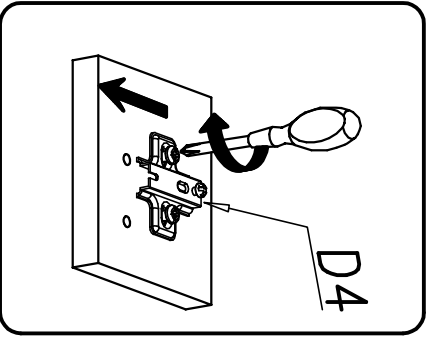
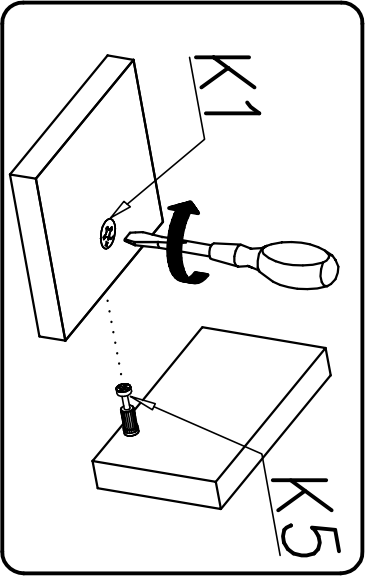
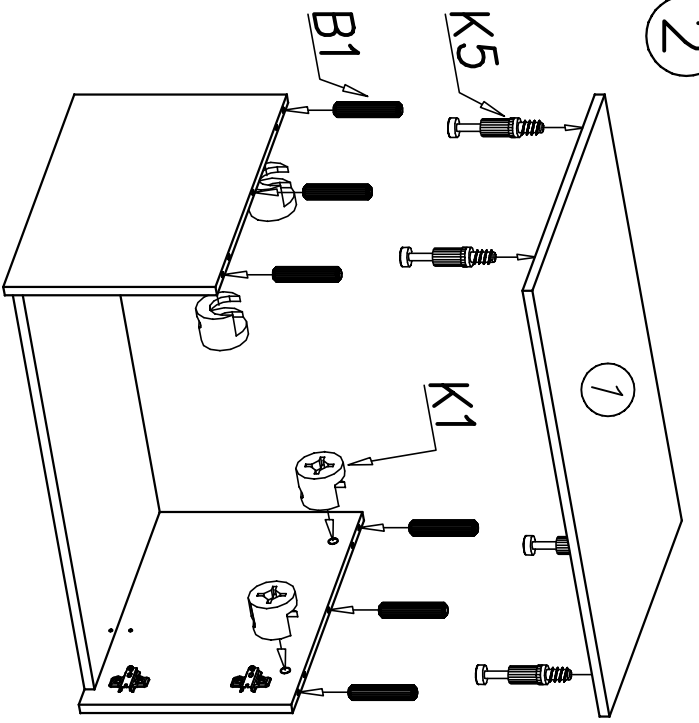

3

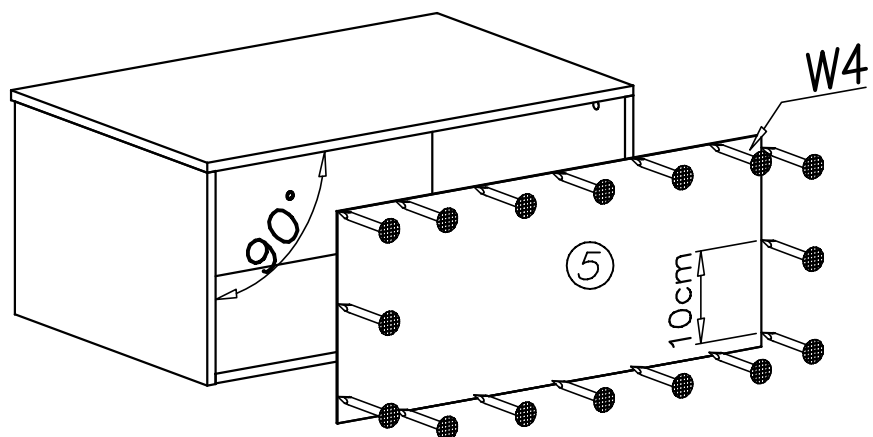

4

