









	 60 min	
Instrukcja montażu – szafa T12/G12		

				
K	KD	KL	W – Ø3,5x16	G
				
ZS		U	N	

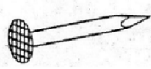
1

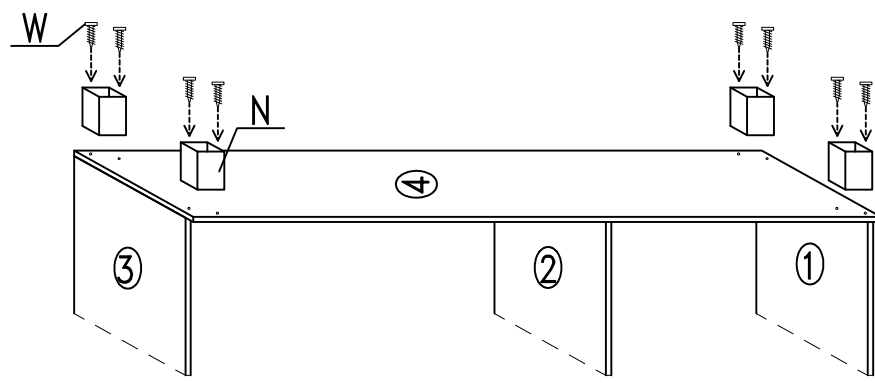

2

