

Modellname:  
Nazwa modelu:

**DOVER**

Modellreihe:  
Numer modelu:

**SL -- 08**

Type:  
Typ:

**12**

Blatt Nr  
Strona

von:  
z:

**MONTAGEANLEITUNG  
INSTRUKCJA MONTAŻOWA**

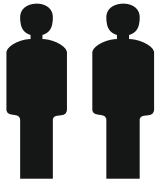

**2 Personen  
2 Osoby**

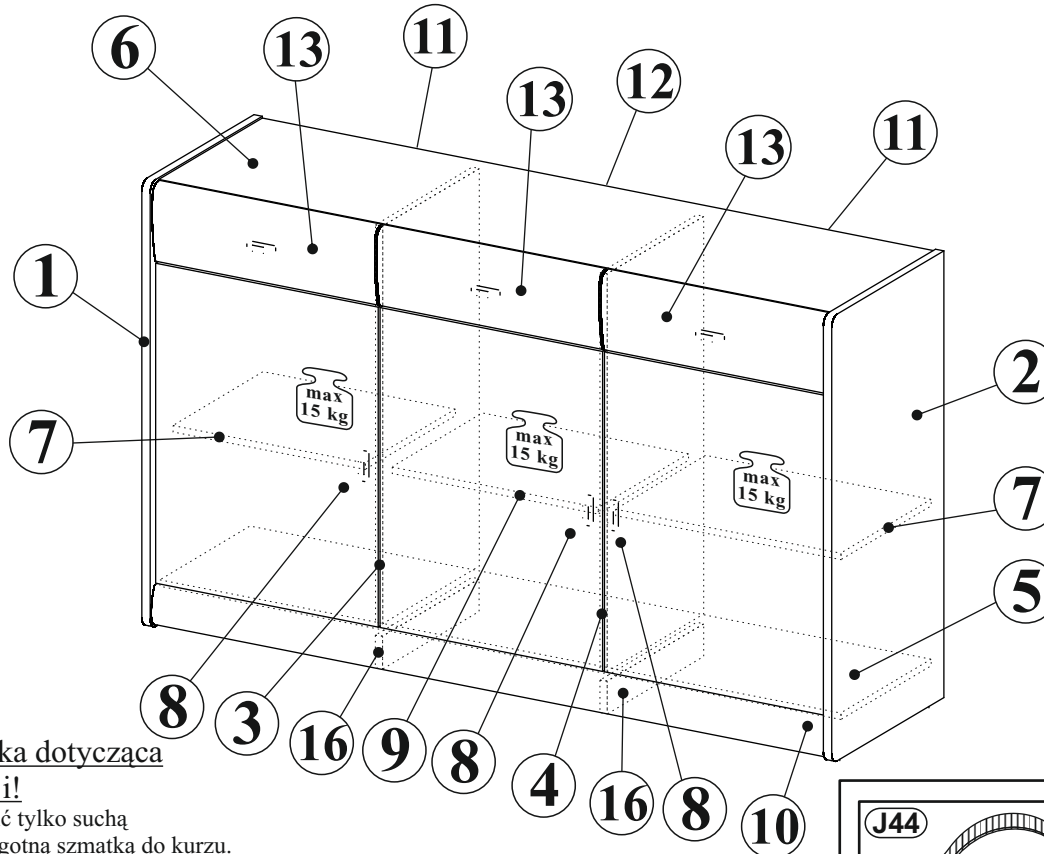
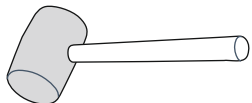
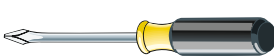
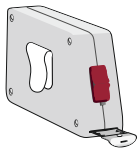

**Wskazówka dotycząca  
pielęgnacji!**





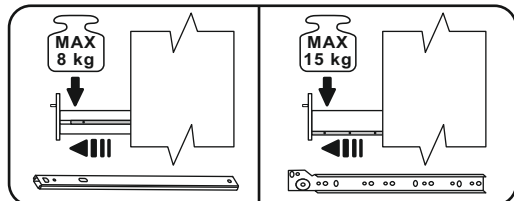



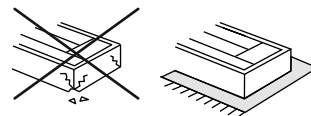



















Proszę czyścić tylko suchą  
lub lekko wilgotną szmatką do kurzu.  
Nie używać żadnych środków szorstkich!  
Maksymalne obciążenie półek w kg:

Stärke/Gr.	Spanplatte/Płyta		
Länge/Dł. mm	15	18	22
0<400			
401<600	40	40	40
601<800	24		
801<1000	15	30	



**MONTOWAĆ  
NA ROZŁOŻONYM KARTONIE!**



<b>F15</b>  x8	<b>B1</b>  x26 φ 8x28
<b>L10</b>  x2	<b>M1</b>  x24
<b>F6</b>  x2	<b>T1</b>  x24
<b>P13</b>  3,5x13 mm x4	<b>C2</b>  x24
<b>U16</b>  x6	<b>W1</b>  x12
<b>A2</b>  M4x22 x6	<b>F1</b>  x16
<b>A15</b>  M4x35 x6	<b>P33</b>  x62
<b>L1</b>  Klej x1	<b>Y1</b>  φ26 KR15 x4
<b>J44</b>  x2	<b>Y2</b>  φ26 KR8Z x2
<b>P13</b>  3,5x13 x2	<b>Y5</b>  H2 x6
<b>G22</b>  φ18 x4	<b>E4</b>  6,0x8,0 x12
<b>T13</b>  φ8 x2	<b>A1</b>  M4x9 mm x6
<b>S15</b>  4x45 x2	<b>J23</b>  x12
	<b>E1</b>  6,3x13 x12
	<b>S8</b>  4x13 x12

**1**

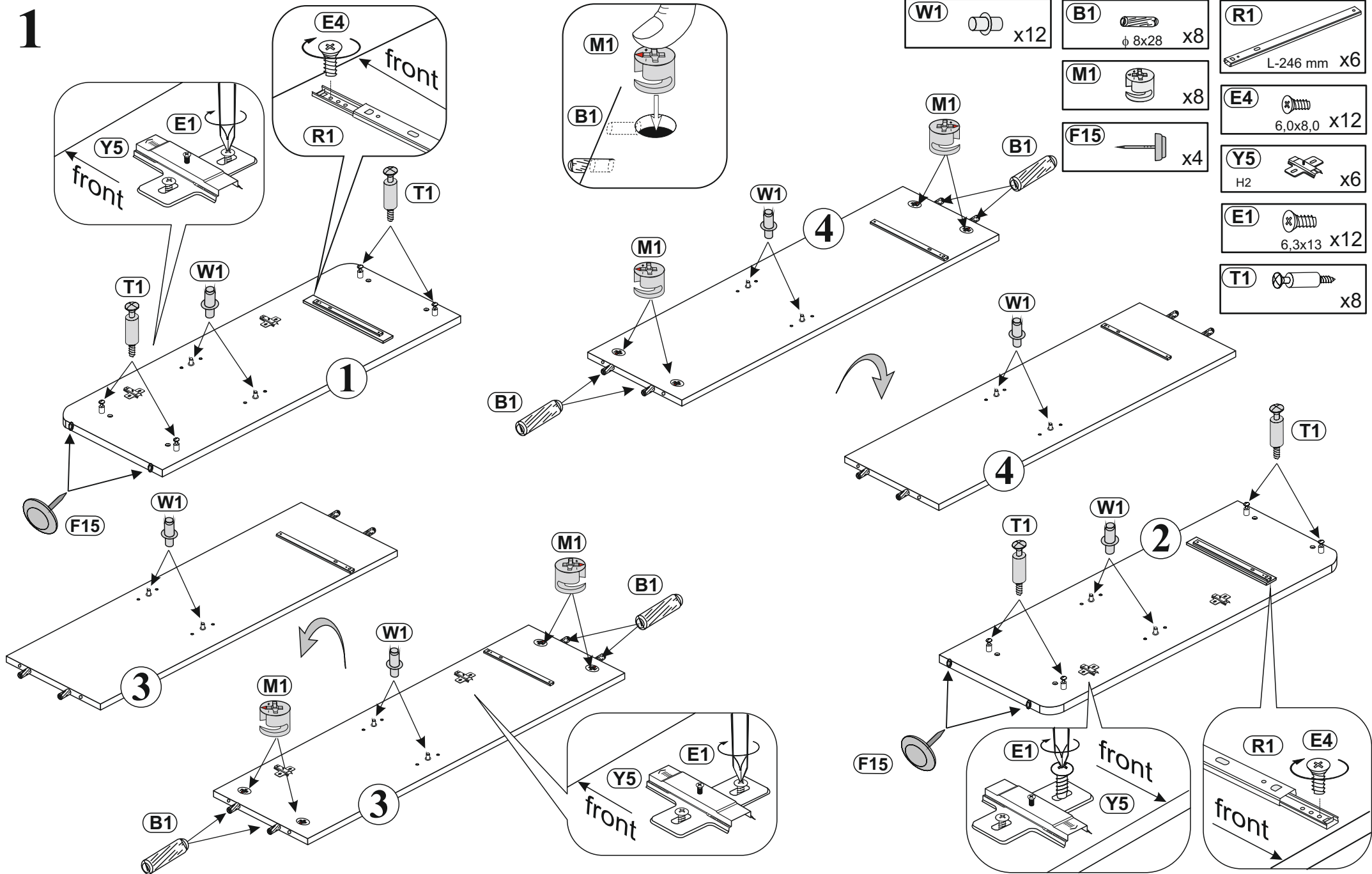

**2**

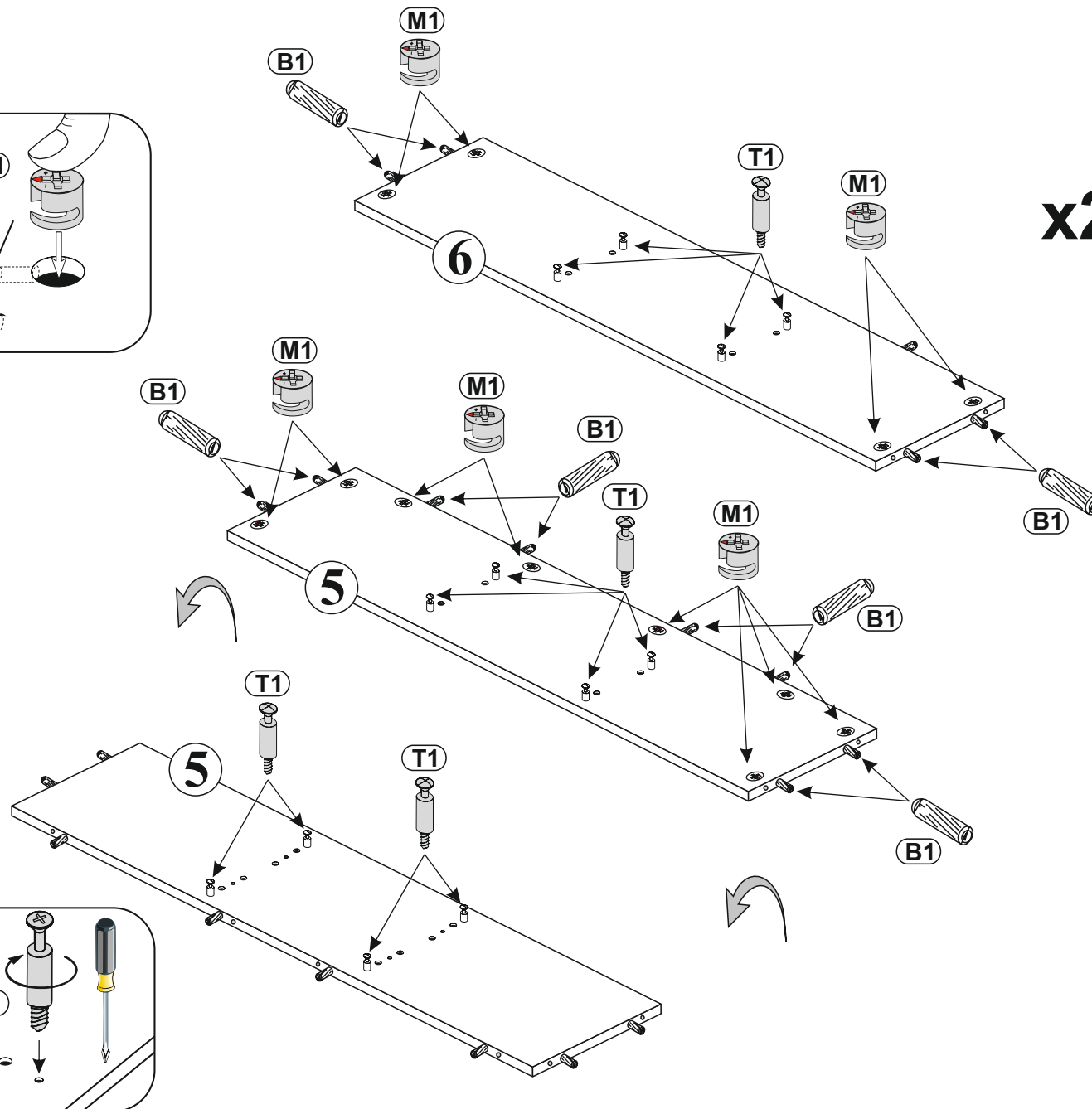
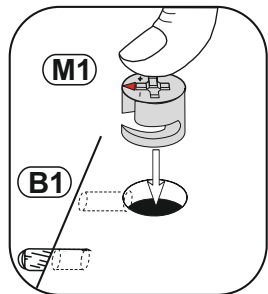

**x2**

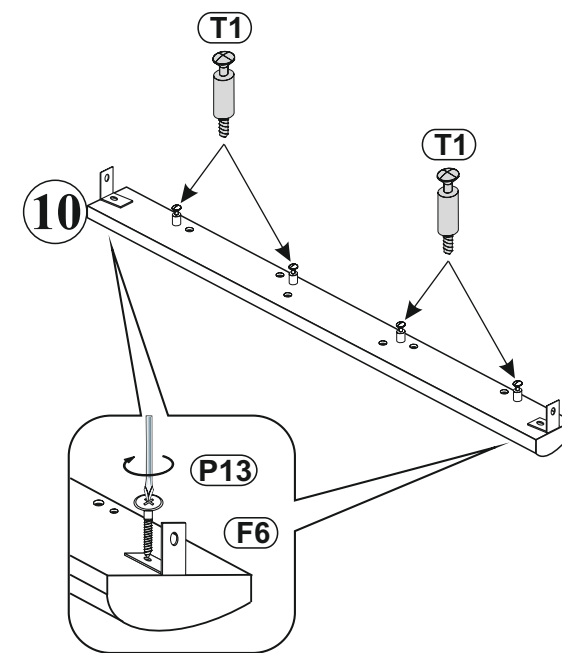
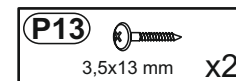
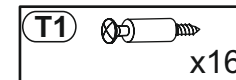
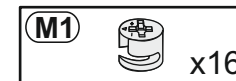
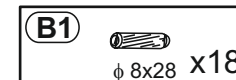
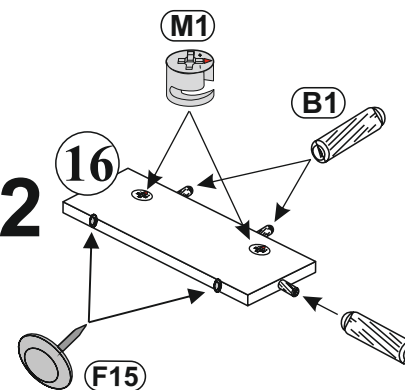

**3**

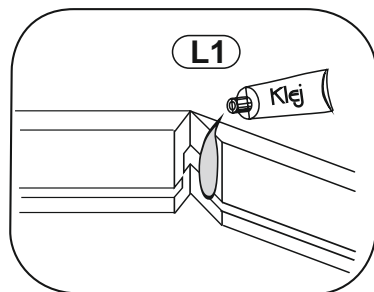

**A**

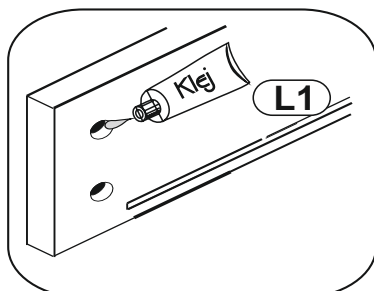

**B**

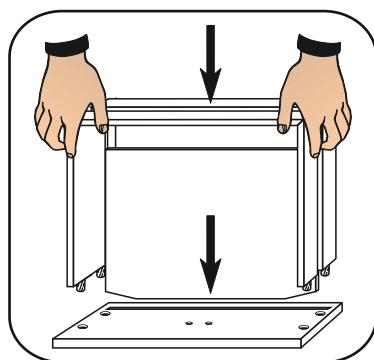

**C**

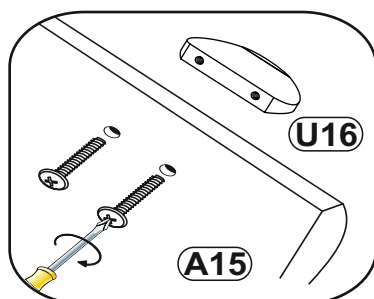

**D**

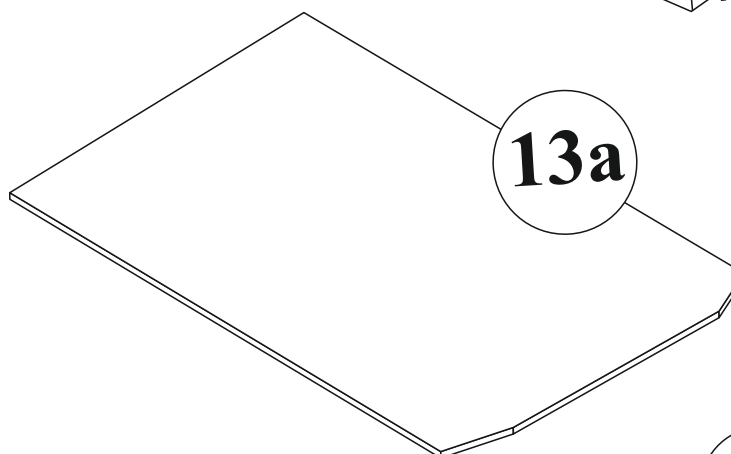
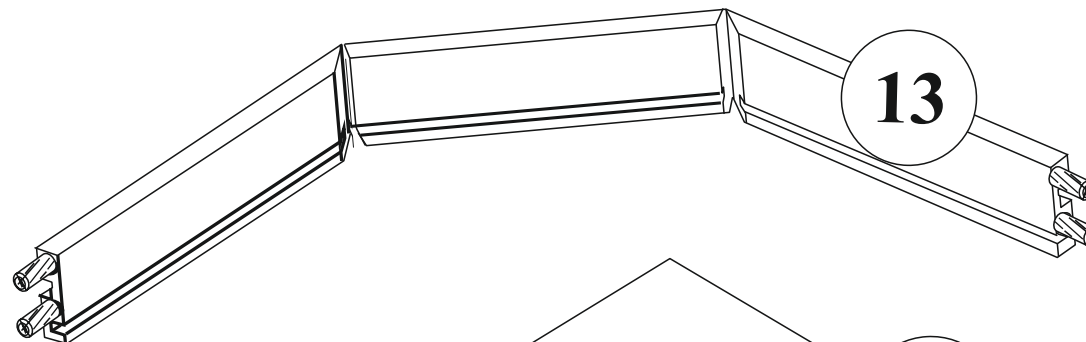

**x3**

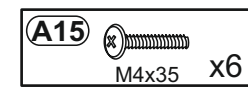
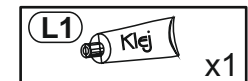
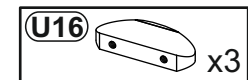
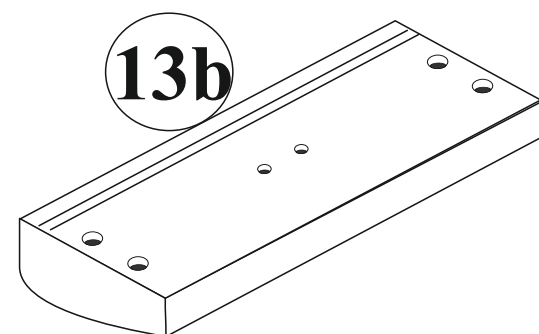

**4**

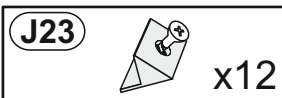

**3x**

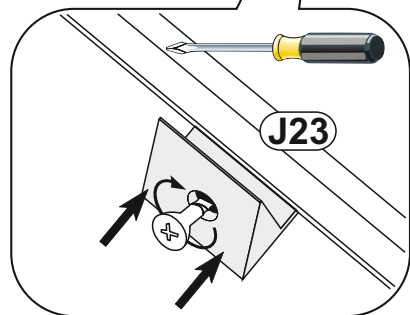
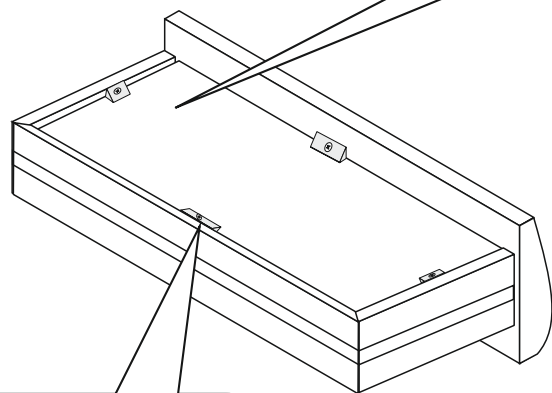
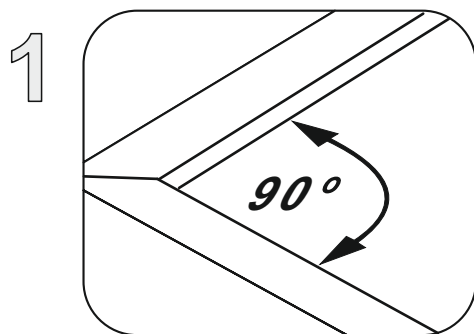

**5**

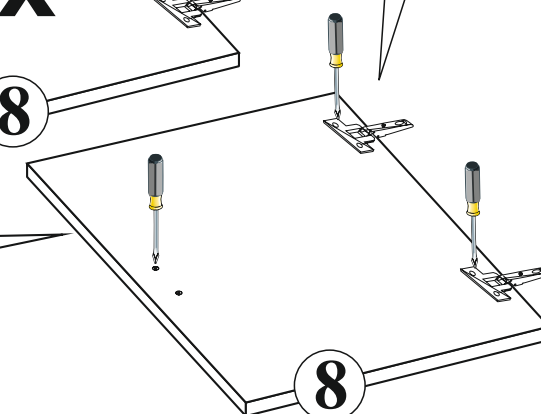
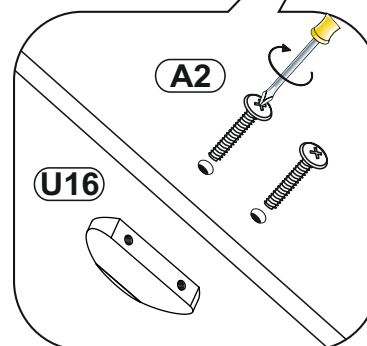
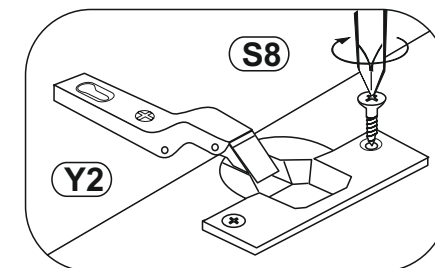
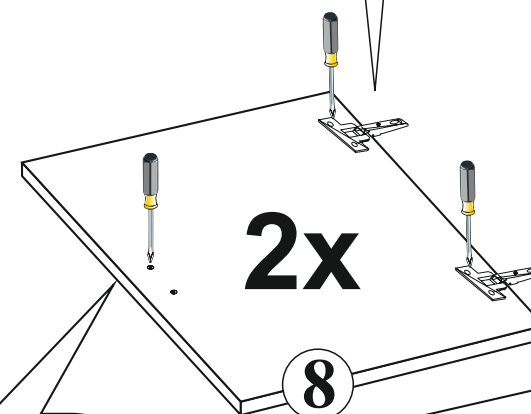
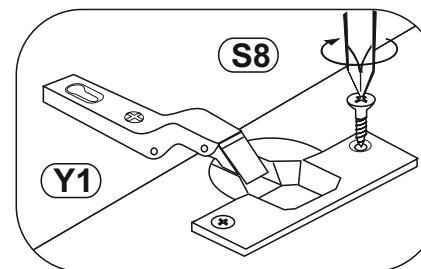
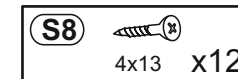
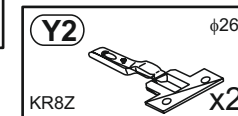
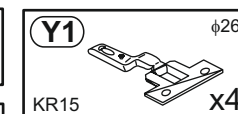
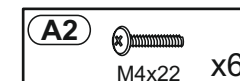
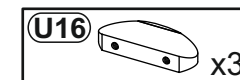

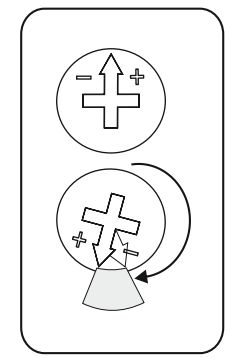
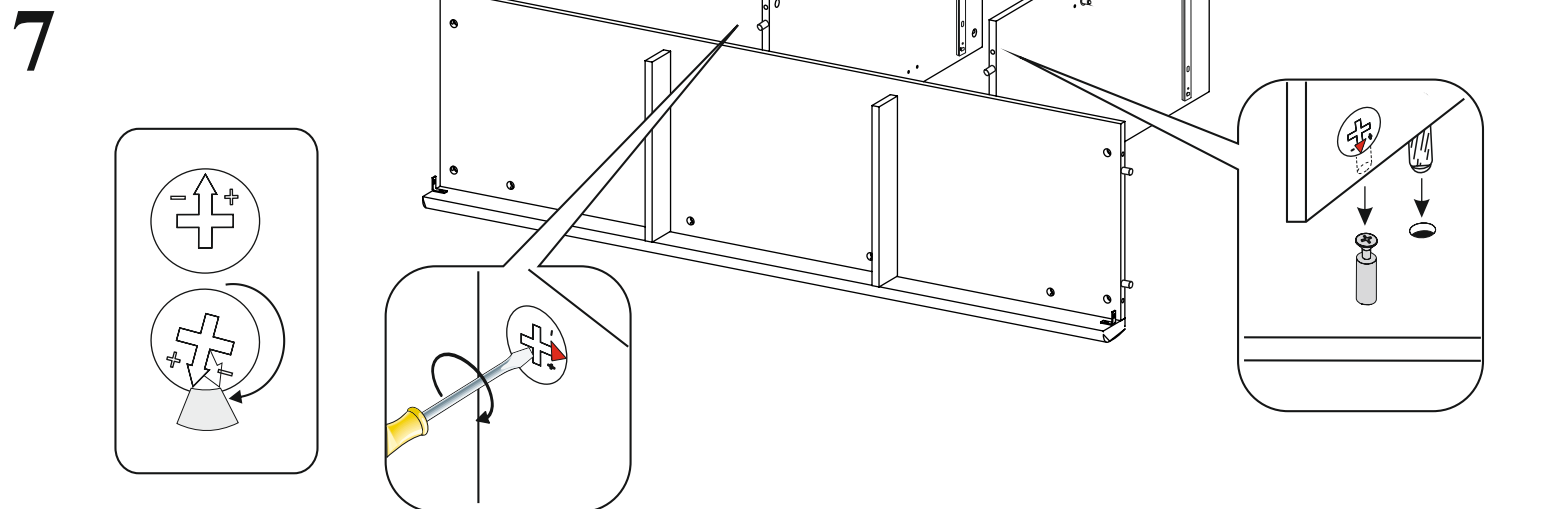
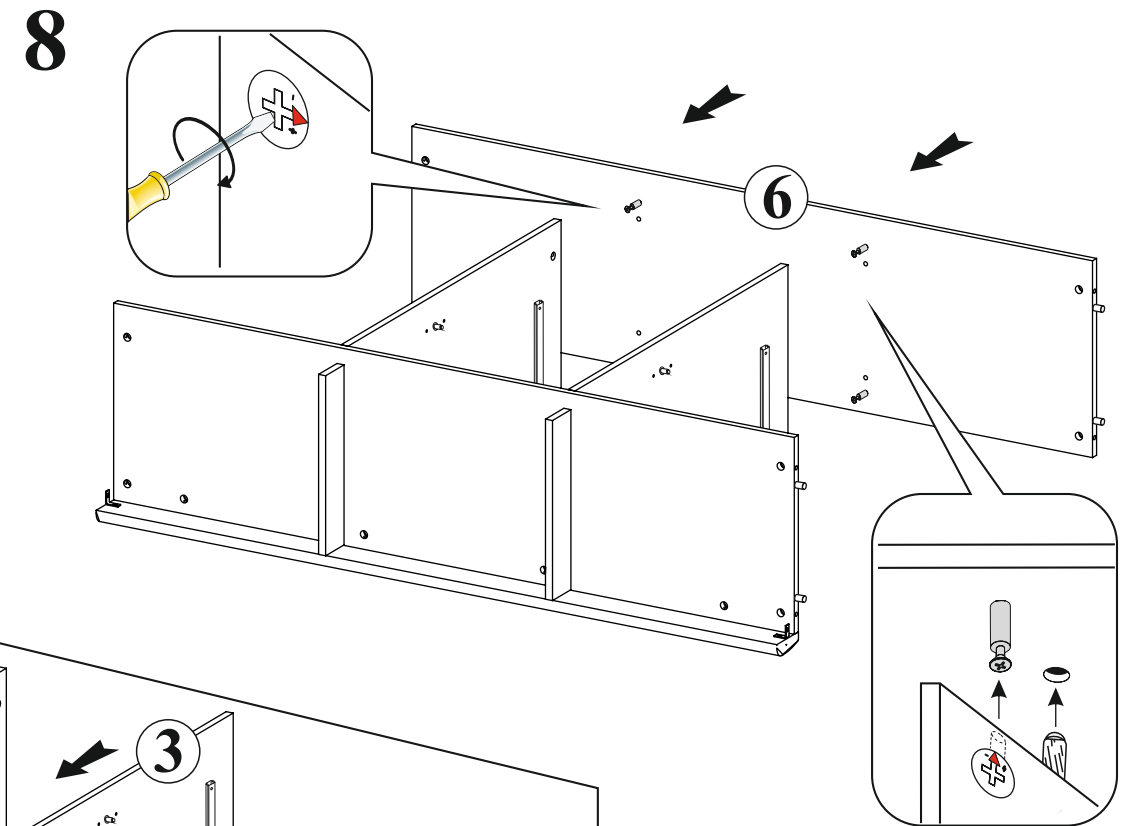
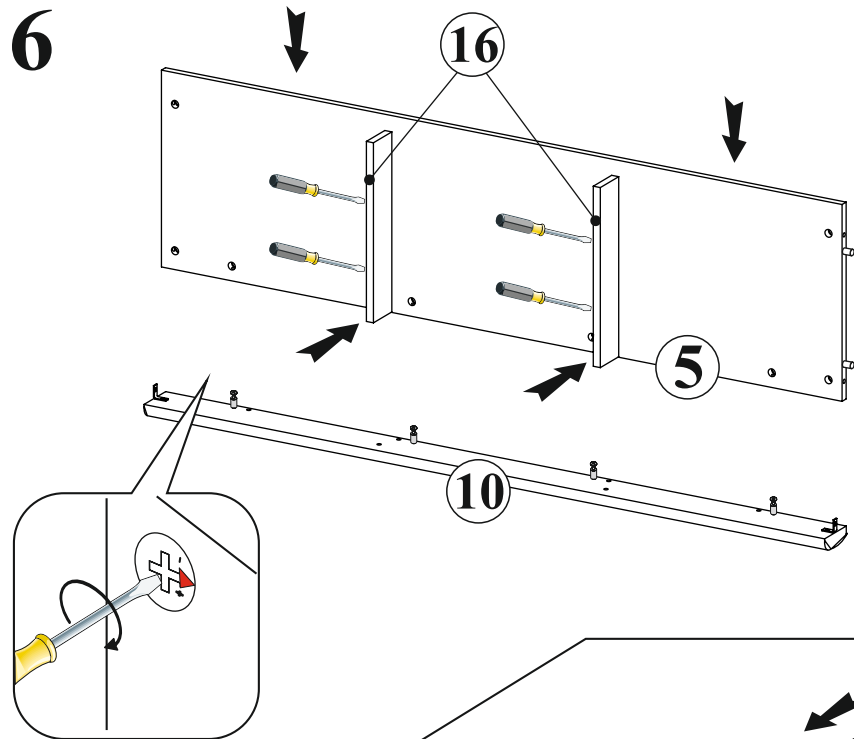

**9**

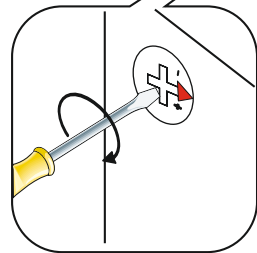
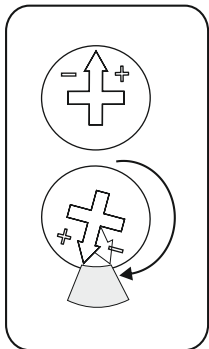
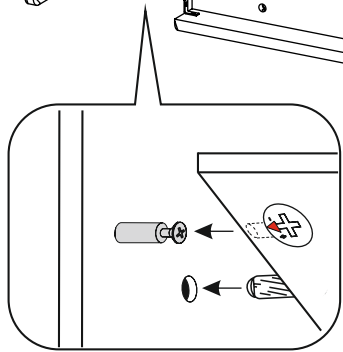
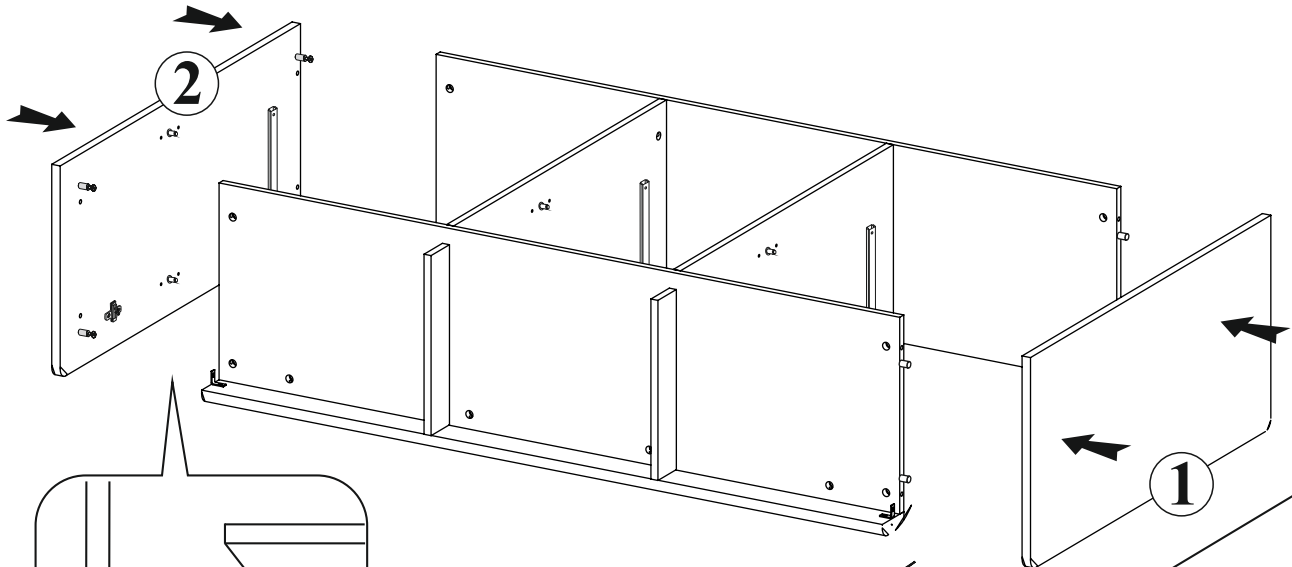

**10**

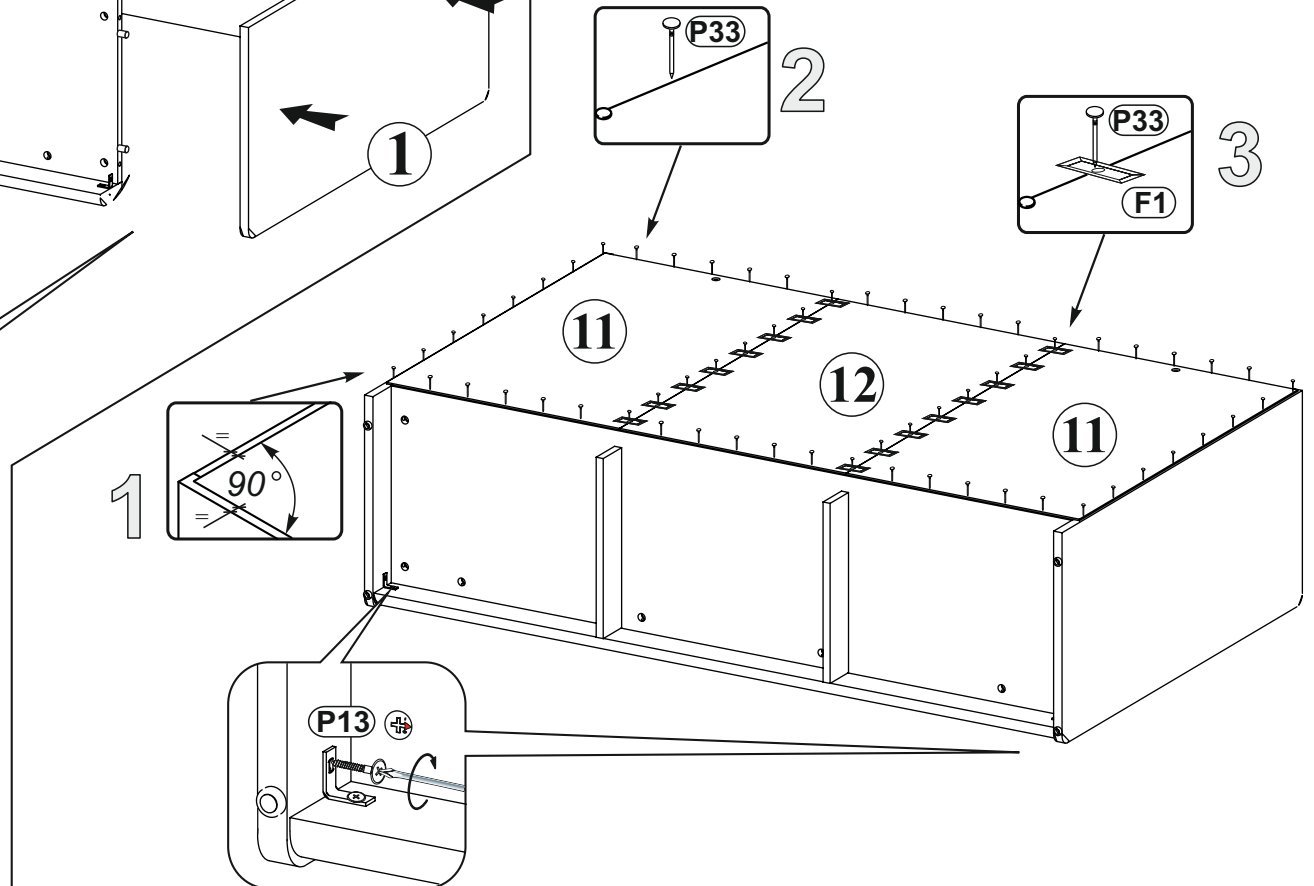
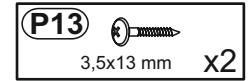
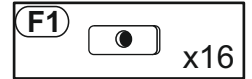
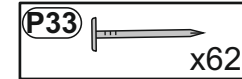

**1**

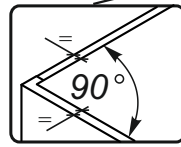

**11**

**12**

**11**

**P13**



Modellname: **DOVER**  
Nazwa modelu:

Modellreihe: **SL -- 08**  
Numer modelu:

Type: **12**  
Typ:

Blatt Nr **8** von: **8**  
Strona **8** z: **8**

**11**

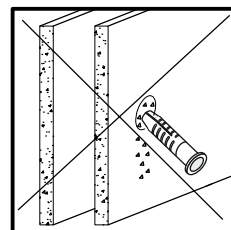
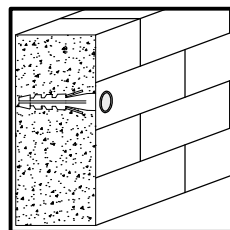
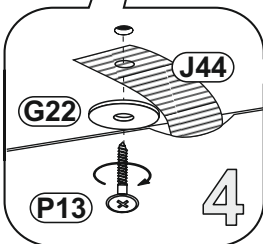
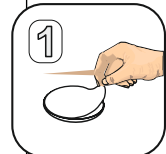
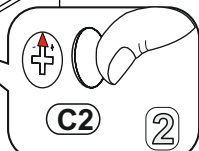
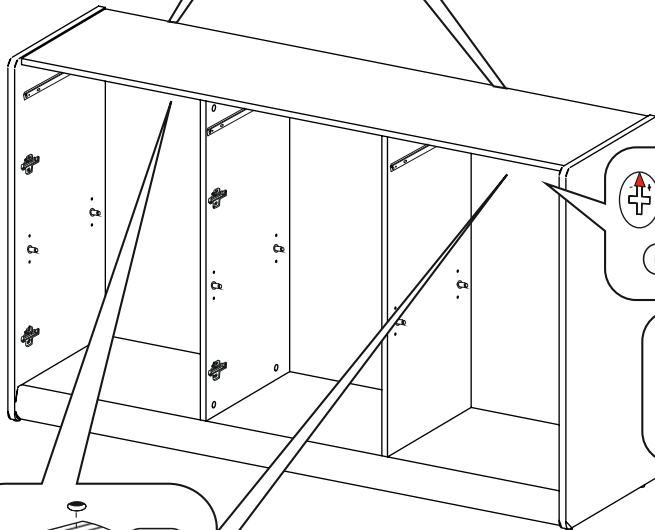
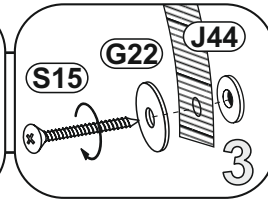
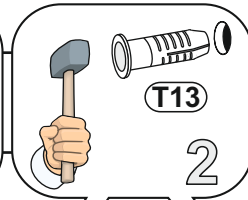
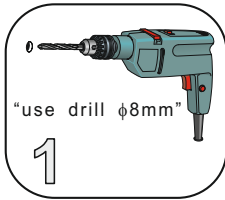
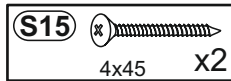
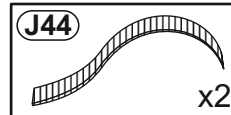
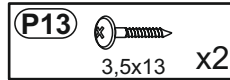
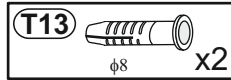

**12**

