

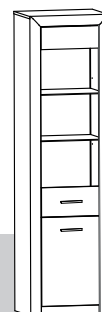

www.MLMEBLE.pl

GB D CZ SK RUS LT  
assembly instructions / montageanleitung / montážní návod / montážny návod / инструкции по монтажу / surinkimo instrukcija



# INSTRUKCJA MONTAŻU

**CASTEL 04/S**  
 201 55 43



akcesoria / accessories / zubehör / příslušenství / príslušenstvo / аксессуары / furnitūra :



x 18  KK 8/32	x 4  WT 4x30	x 26  BMD	x 22  ZAM	x 14  ZAN	x 2  MD2 L68	x 22  ZMD	x 4  PA Ø5	x 1  klej / glue / kleber / lepidlo / lepidlo / клей / klīja	x 8  WE 6,3x13 B	x 16  WT 3,5x16
x 8  SP	x 4  SG 8/8	x 6  WE 6,3x16ES	x 6  TD 01	x 8  PO Ø5	x 4  ZPR	x 4  PK H-2	x 2  UT 1.181	x 8  GZ 1,4/25	x 2  KT 50	x 1  PKZ

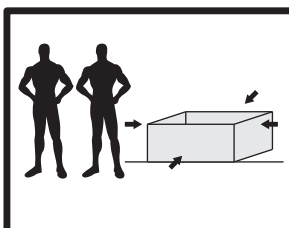
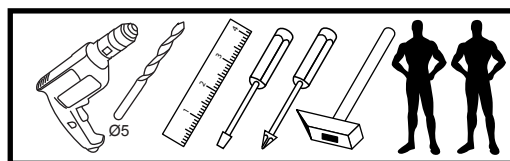

do montażu potrzebne są:  
 are needed for assembly:  
 sind erforderlich für die montage:  
 jsou potřebné pro montáž:  
 sú potrebné pre montáž:  
 которые необходимы для сборки:  
 Surinkimui reikės

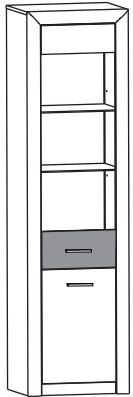

**UWAGA !** - mebel należy składać w pozycji poziomej  
**WARNING!** - furniture should be submitted in a horizontal position  
**WARNUNG!** - Möbel sollten in einer horizontalen Position vorzulegen  
**POZOR!** - Nábytek by měl být předložen ve vodorovné poloze  
**POZOR!** - Nábytek by mal byť predložený vo vodorovnej polohe  
**ВНИМАНИЕ!** - Мебель должна быть представлена в горизонтальном положении  
**DĚMESIO!** - Baldą surenkame horizontalioje padėtyje



	CODE		
1	CASTEL04S_01	543	400
2	CASTEL04S_02	508	384
3	CASTEL04S_03	1986	400
4	CASTEL04S_04	1986	400
5	CASTEL04S_05	508	384
6	CASTEL04S_06	507	372
7	CASTEL04S_07	398	594
8	CASTEL04S_08	398	150
9	CASTEL04S_09	508	60
10	CASTEL04S_10	196	398
11	CASTEL04S_11	70	2003
12	CASTEL04S_12	70	2003

	CODE		
13	CASTEL04S_13	70	543
14	CASTEL04SHDF_01	1929	259
15	4SZKL-4NR6	396	984
16	4SZKL-5NR20	355	507
17			
18			
19			
20			
21			
22			
23			
24			

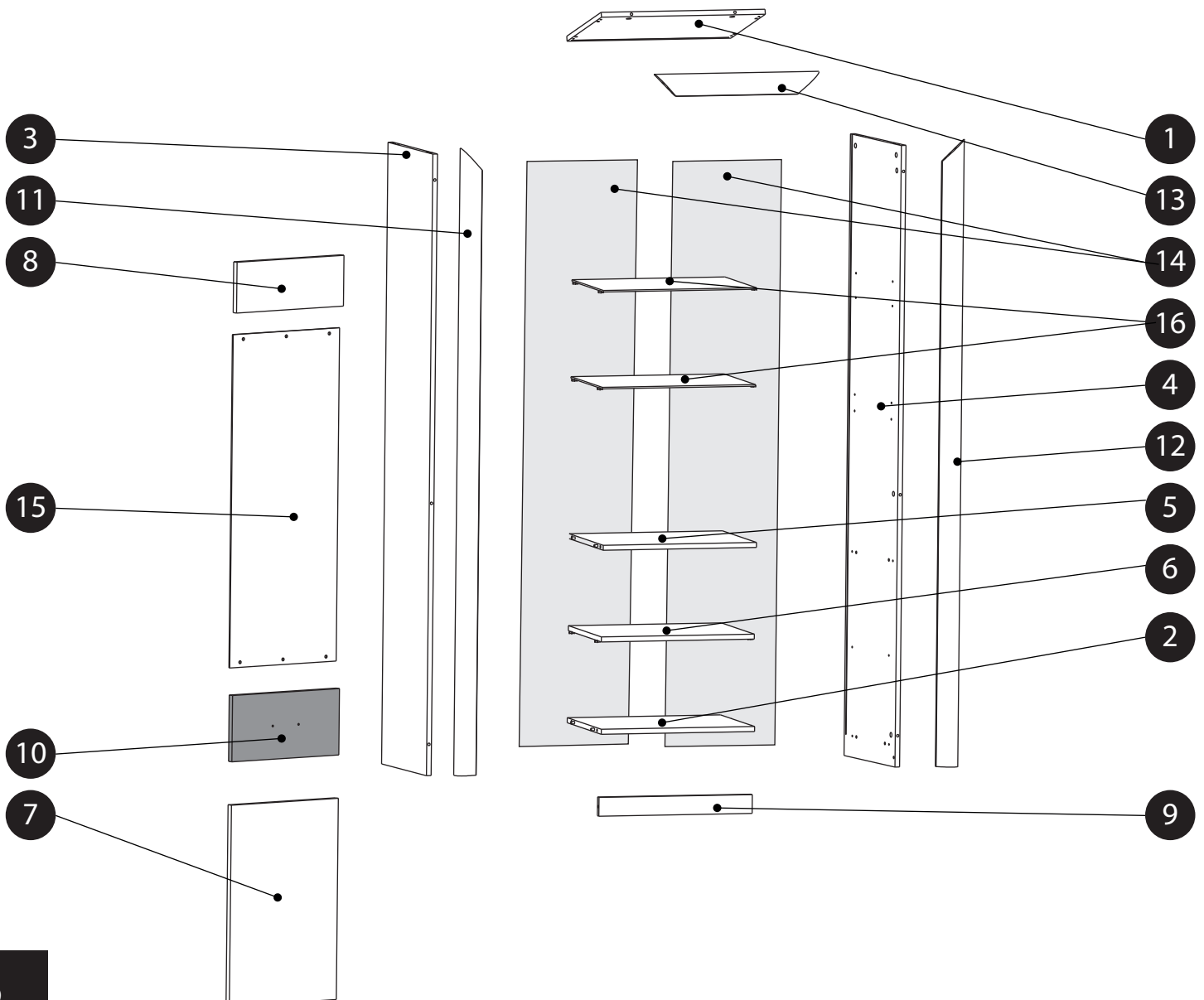

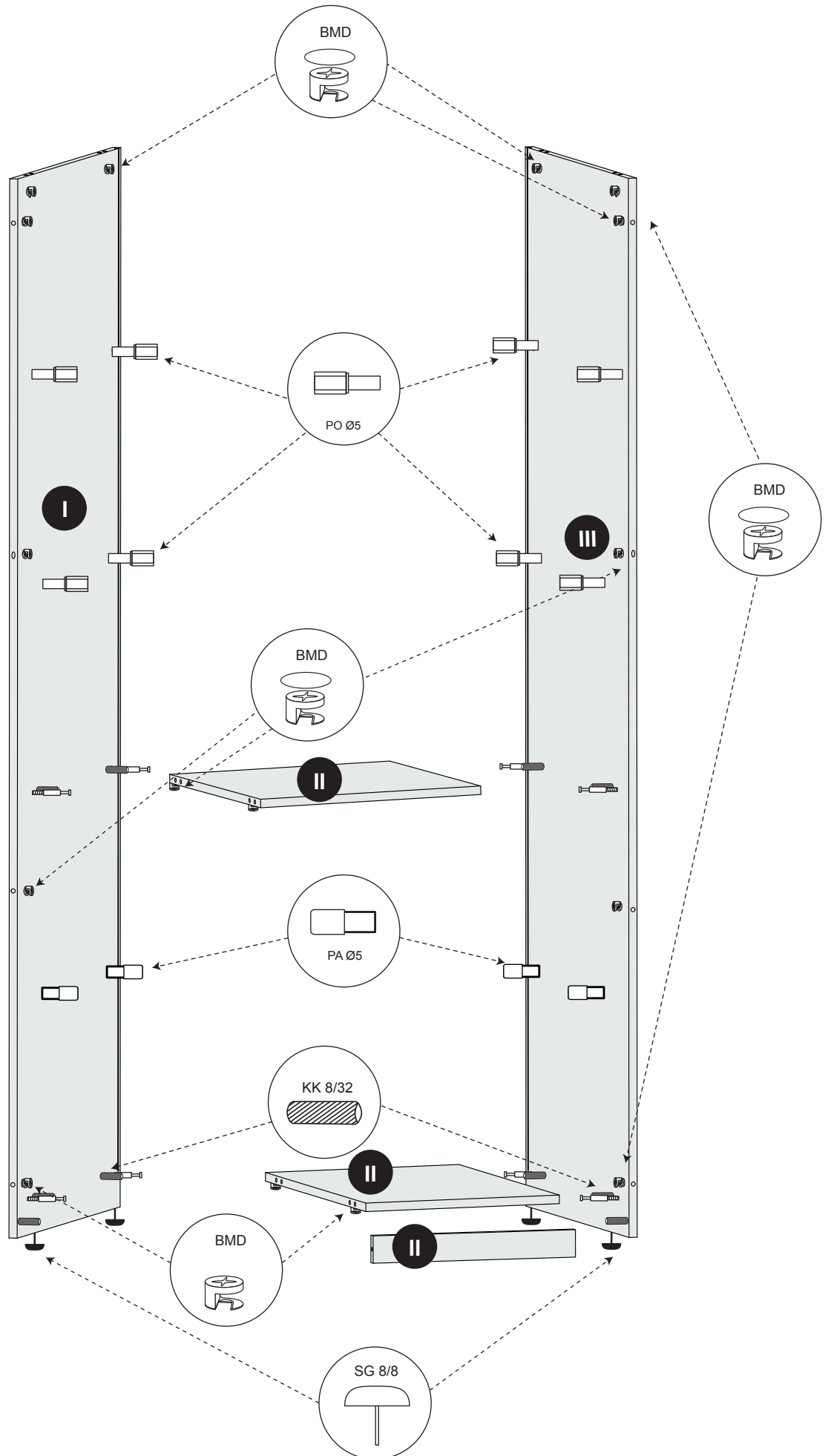
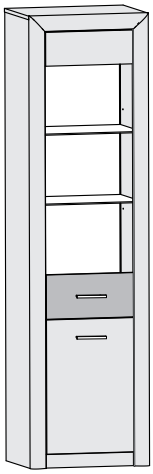

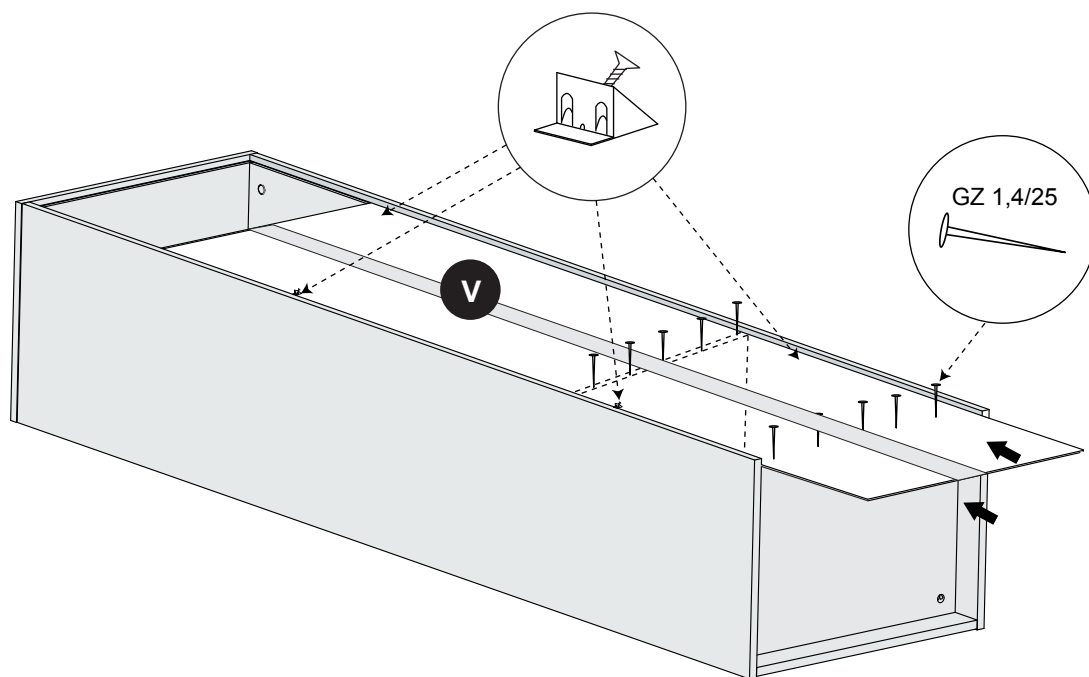
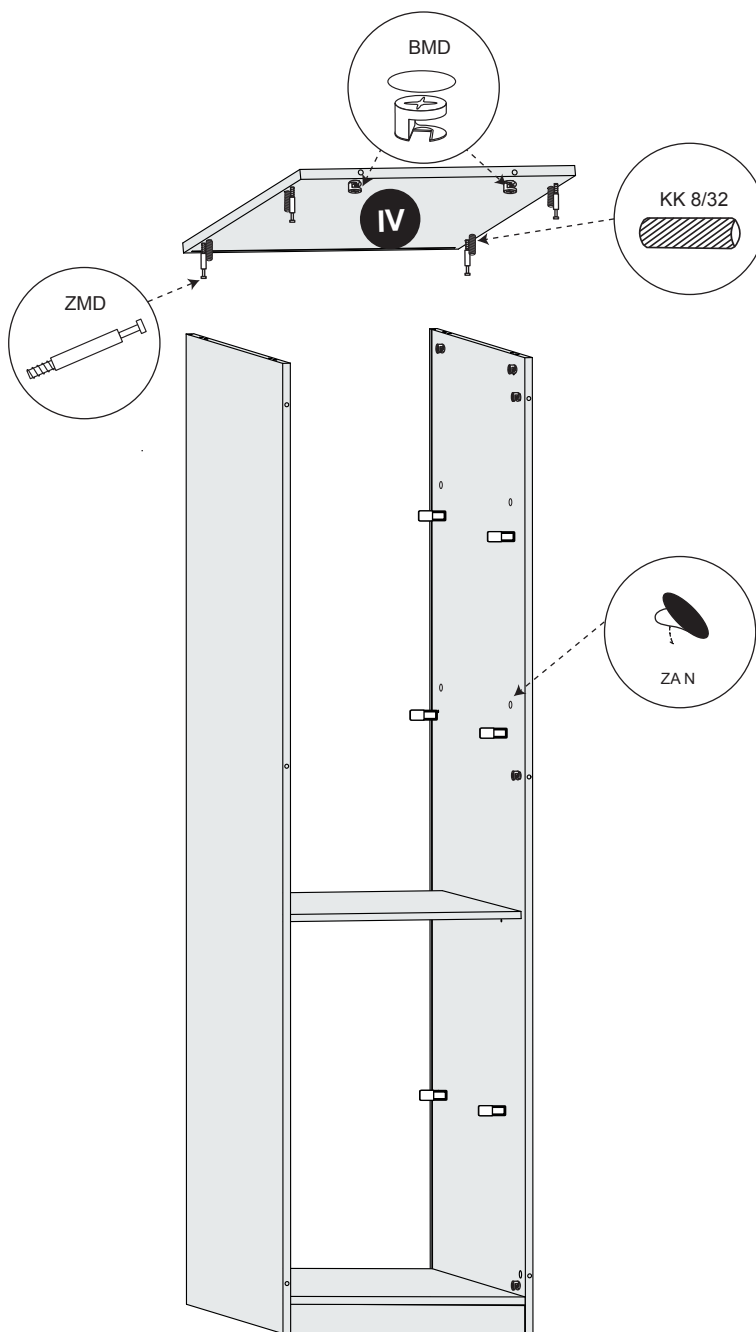
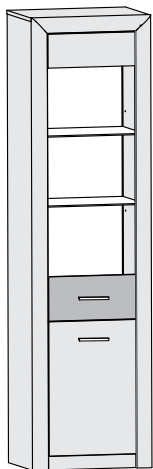

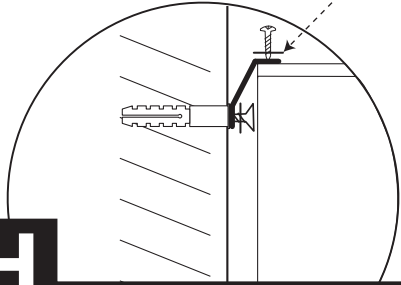
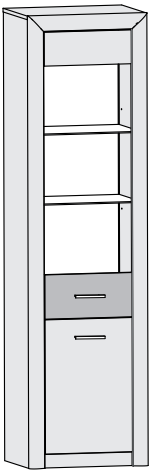

**H!**  
**UWAGA!** - Mocowanie do ściany.  
**WARNING!** - Attaching to the wall.  
**WARNUNG!** - Anbringen an der Wand.  
**POZOR!** - Připevnění na stěnu.  
**POZOR!** - Pripevnenie na stenu.  
**ВНИМАНИЕ!** - Крепление к стене  
**DĒMESIO!** - Tvirtinimas prie sienos.

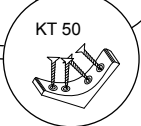
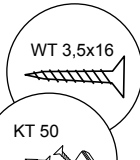
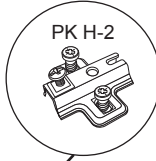
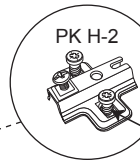
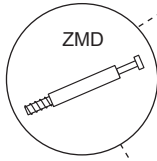
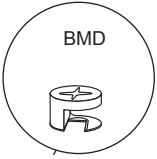
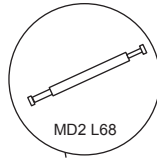
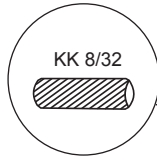
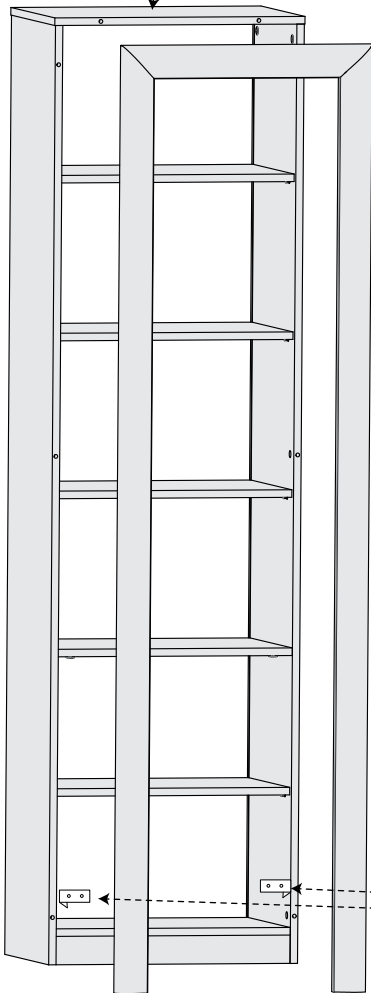

Possibility of assembling the right-left.  
 Möglichkeit der Montage der rechts-links.  
 Možnost montáže vpravo-vlevo.  
 Возможность монтажа вправо-влево  
 Galima padaryti pusę kairę arba dešinę.  
 Surinkimo eiliškumas



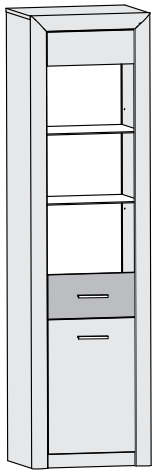

Possibility of assembling the right-left.  
Möglichkeit der Montage der rechts-links.  
Možnost montáže vpravo-vlevo.  
Возможность монтажа вправо-влево  
Galima padaryti pusę kairę arba dešinę.  
Surinkimo eiliškumas

