

PRZED ROZPOCZĘCIEM MONTAŻU ZAPOZNAĆ SIĘ Z INSTRUKCJĄ

Narzędzia niezbędne do montażu (nie dostarczane przez producenta)

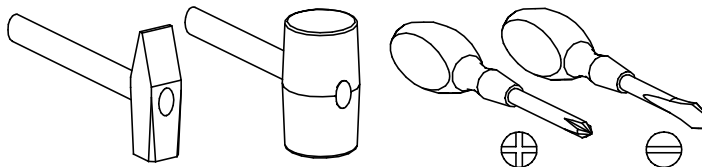

# CARMELO

## 03

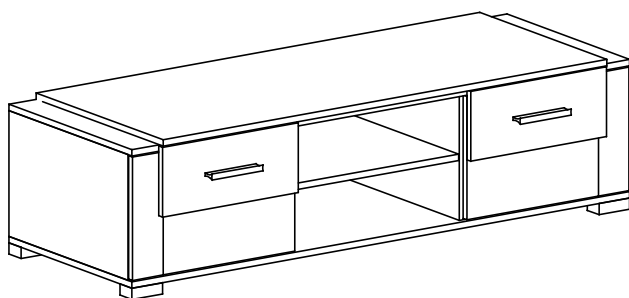

Nr	Nazwa elementu	Dł [mm]	Szer [mm]	Gr [mm]	Ilość	Kod	Paczka
1	półka ruchoma	485	497	16	1		
2	przegroda lewa	311	497	16	1		
3	przegroda prawa	311	497	16	1		
4	bok lewy	311	500	16	1		
5	bok prawy	311	500	16	1		
6	blat dolny	1465	516	16	1		
7	blat górny	1465	516	16	1		
8	nakładka blatu górnego	1305	534	16	1		
9	HDF ściana tylna	1453	331	2,5	1		
10	drzwi lewe	387	305	16	1		
11	listwa drzwi	305	90	16	2		
12	drzwi prawe	387	305	16	1		
13	nakładka drzwi lewych	174	400	16	1		
14	nakładka drzwi prawych	174	400	16	1		

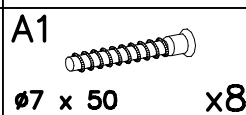
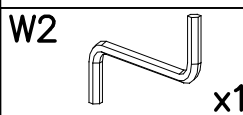
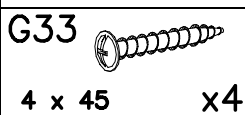
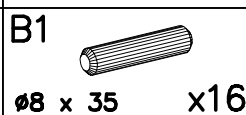
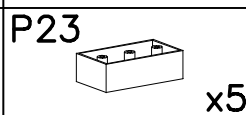
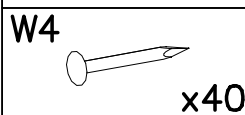
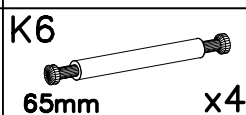
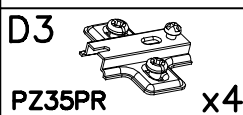
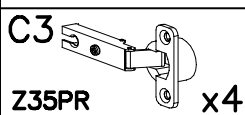
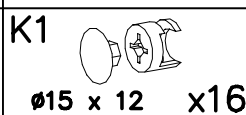
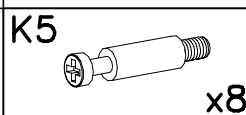
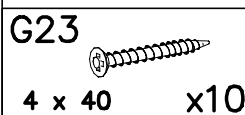
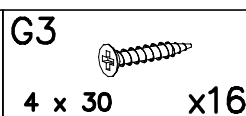
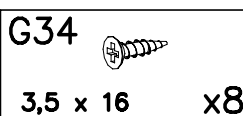
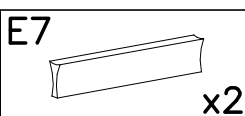
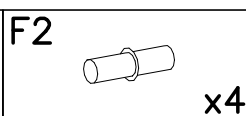
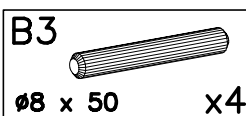
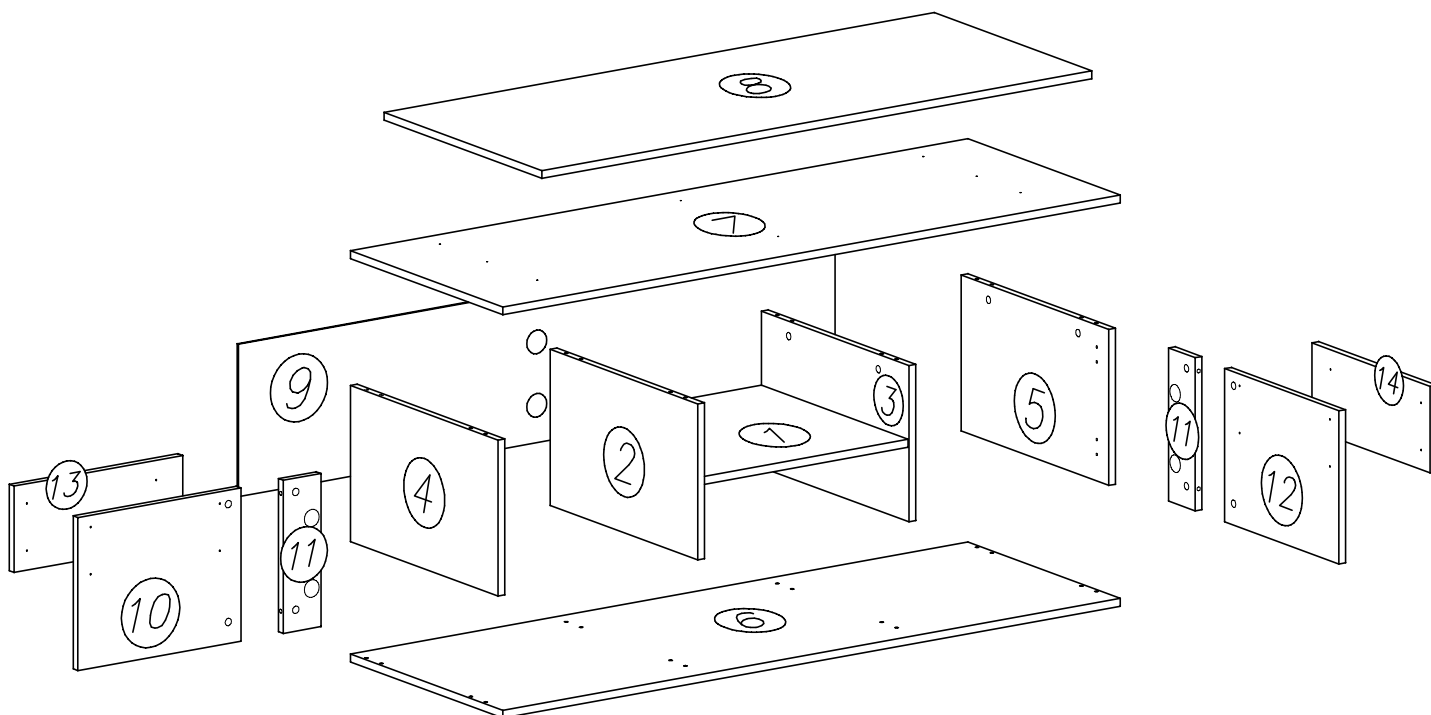

I

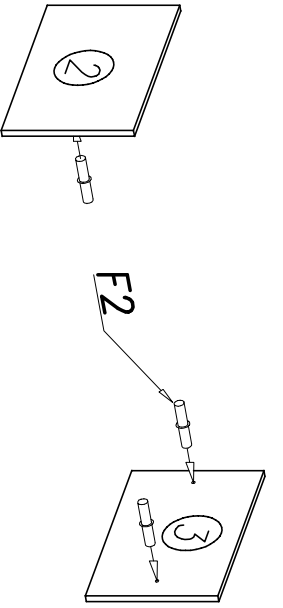

II

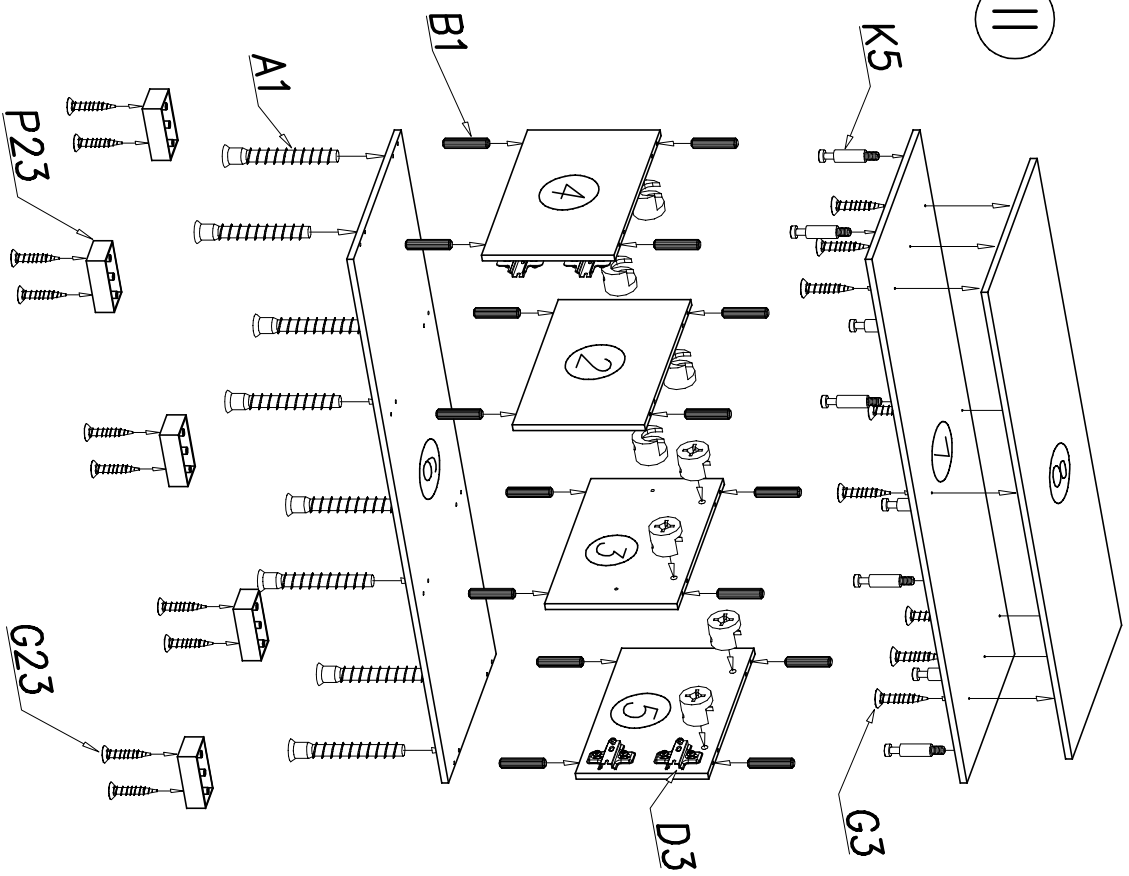

III

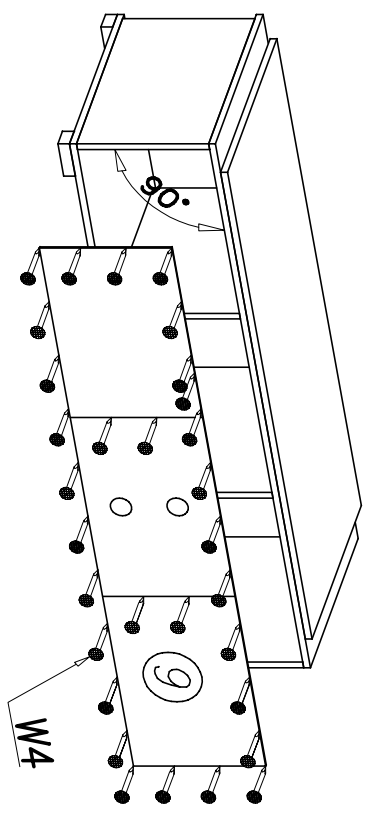

IV

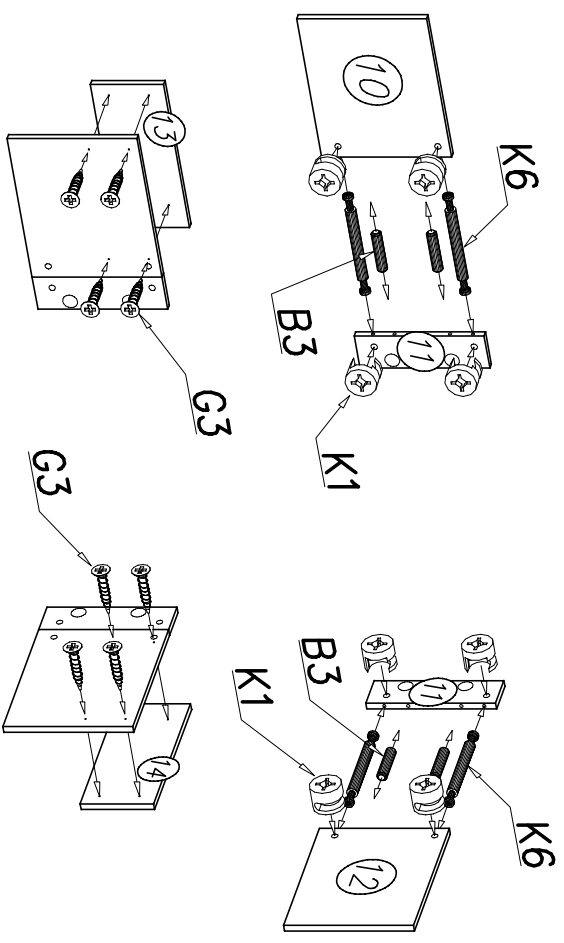

V

