

ANTICA

A4

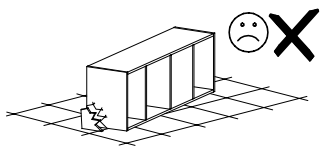

Narzędzia potrzebne do montażu

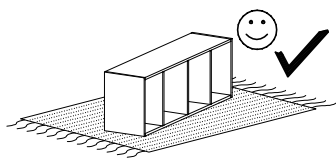
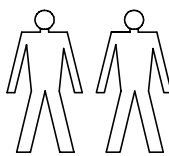
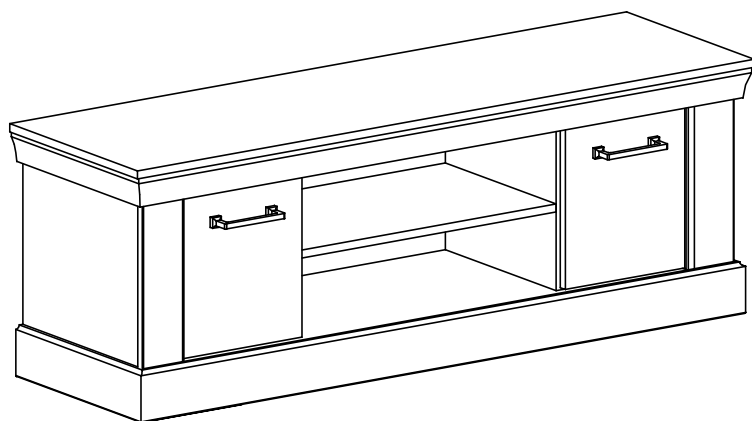
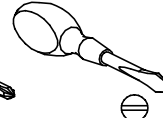
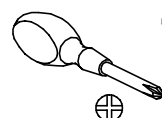
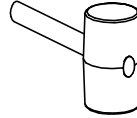
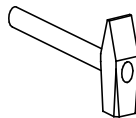

nr	D[mm]	S[mm]	G[mm]	Ilość
1	482	380	16	1
2	482	380	16	1
3	1328	396	16	1
4	1358	80	16	1
5	1390	100	16	1
6	412	100	16	1
7	412	100	16	1
8	1420	420	71	1
9	328	100	32	1
10	328	100	32	1
11	384	364	16	1
12	384	364	16	1
13			2,5	1
14	584	364	16	1
15	322	277	16	1
16	322	277	16	1

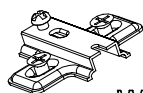

W1 - 2 St.

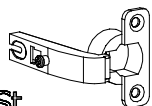

R1 - 2 St.



F - 4 St.

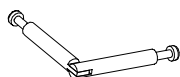

O - 4 St.

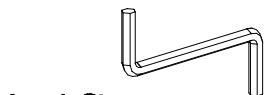

Ł - 1 St.

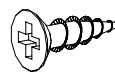

G - 8 St.
3,5x16 mm



L - 24 St.



I - 50 St.



A - 9 St.
7x50 mm

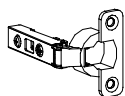

"clip"
R2 - 2 St.

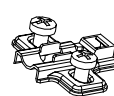

"clip"
W2 - 2 St.

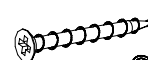

C - 7 St.
3,9x30 mm



B - 16 St.
8x35 mm



Q - 6 St.

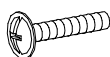

D - 4 St.
M4x25 mm

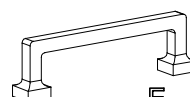

E - 2 St.

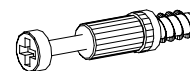

K - 16 St.

I

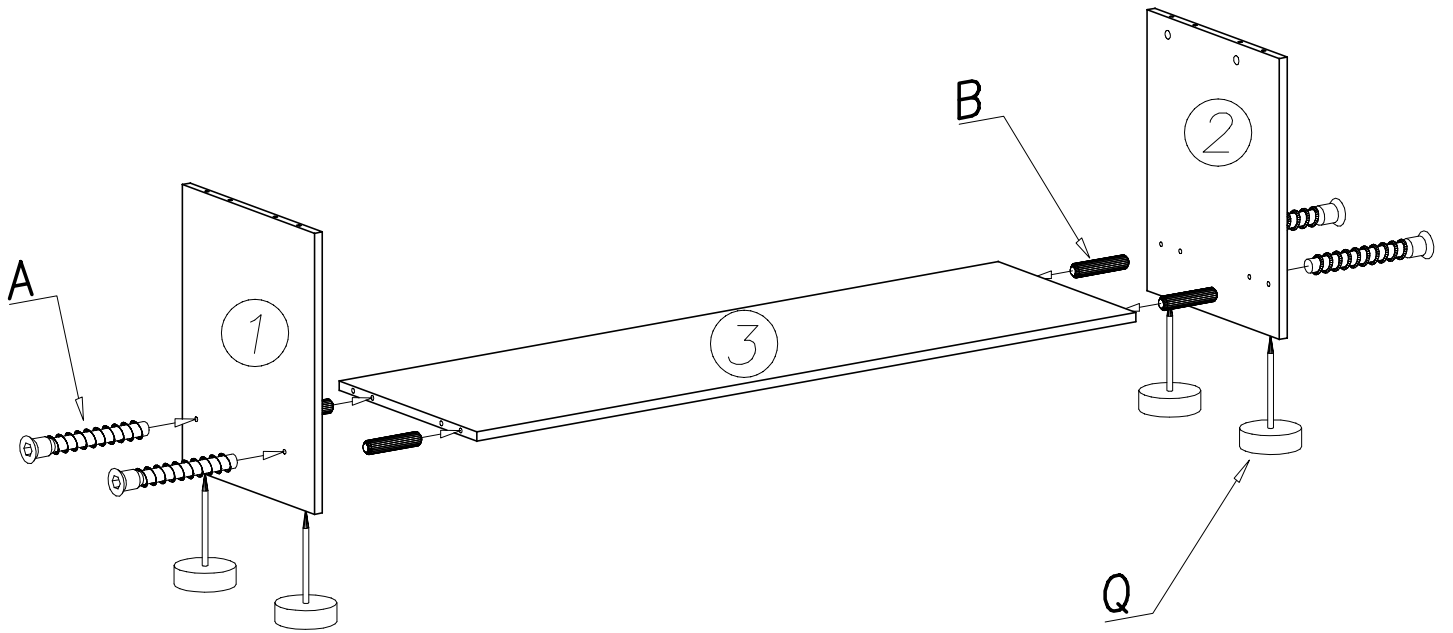

II

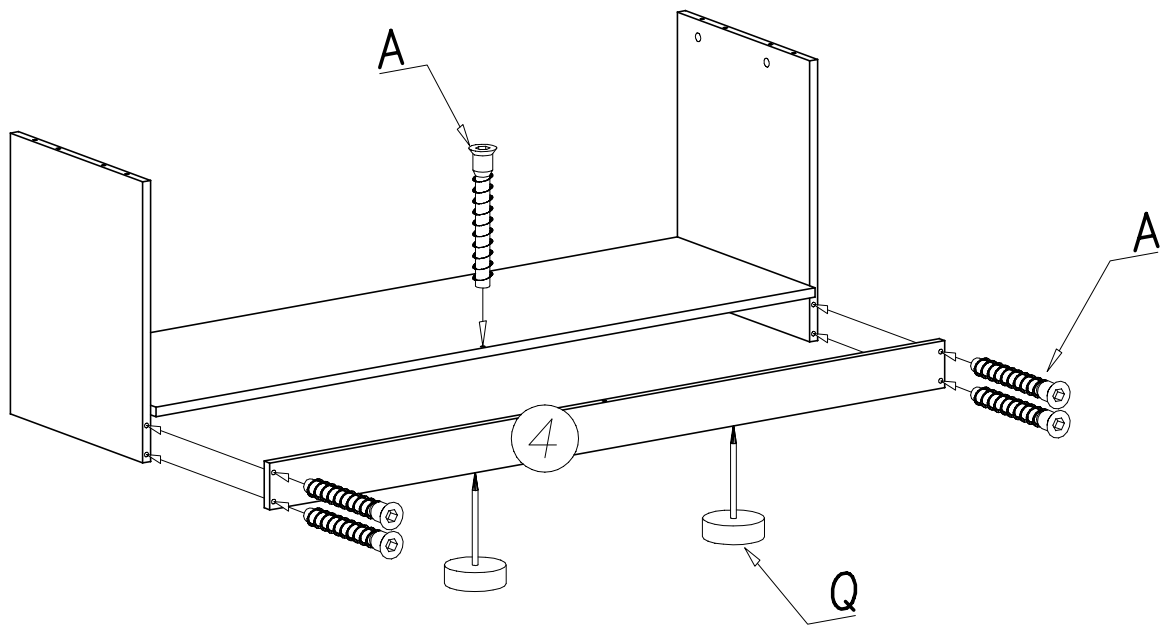

III

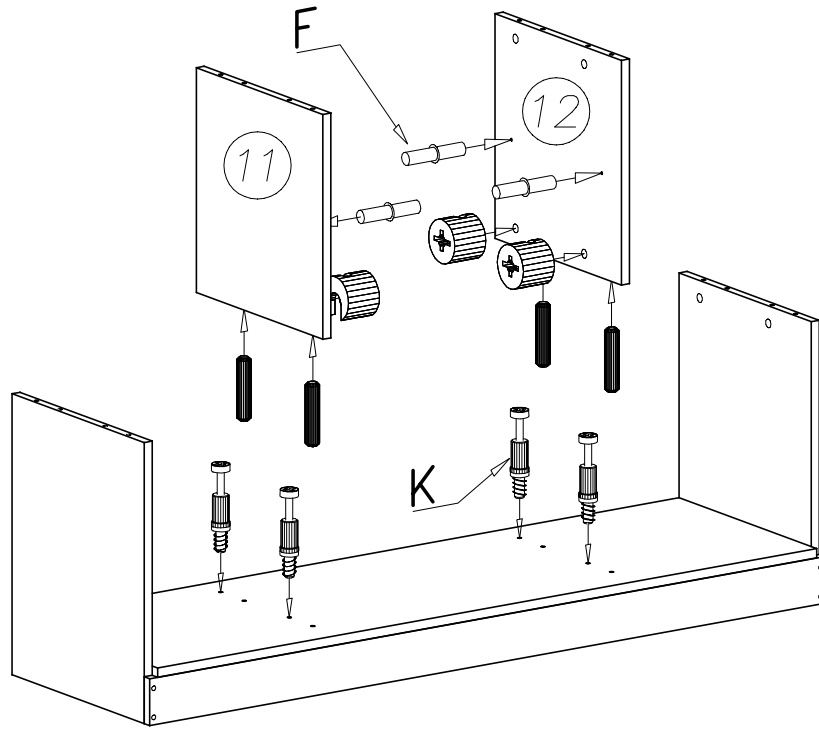

IV

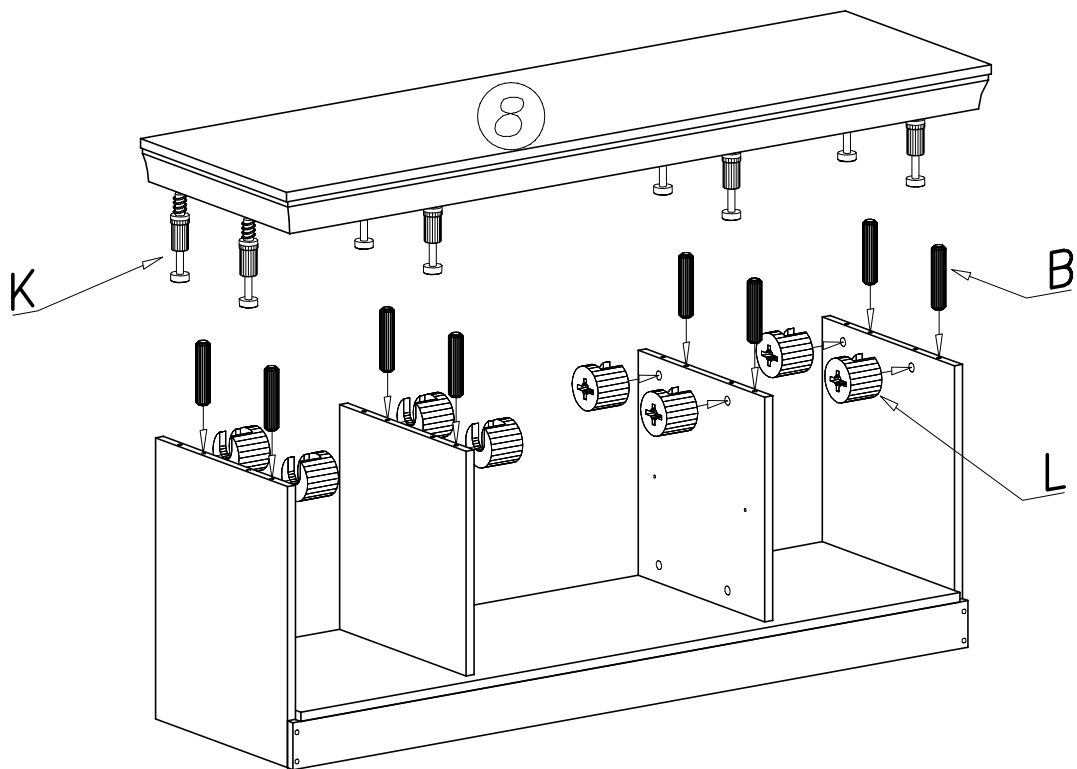

V

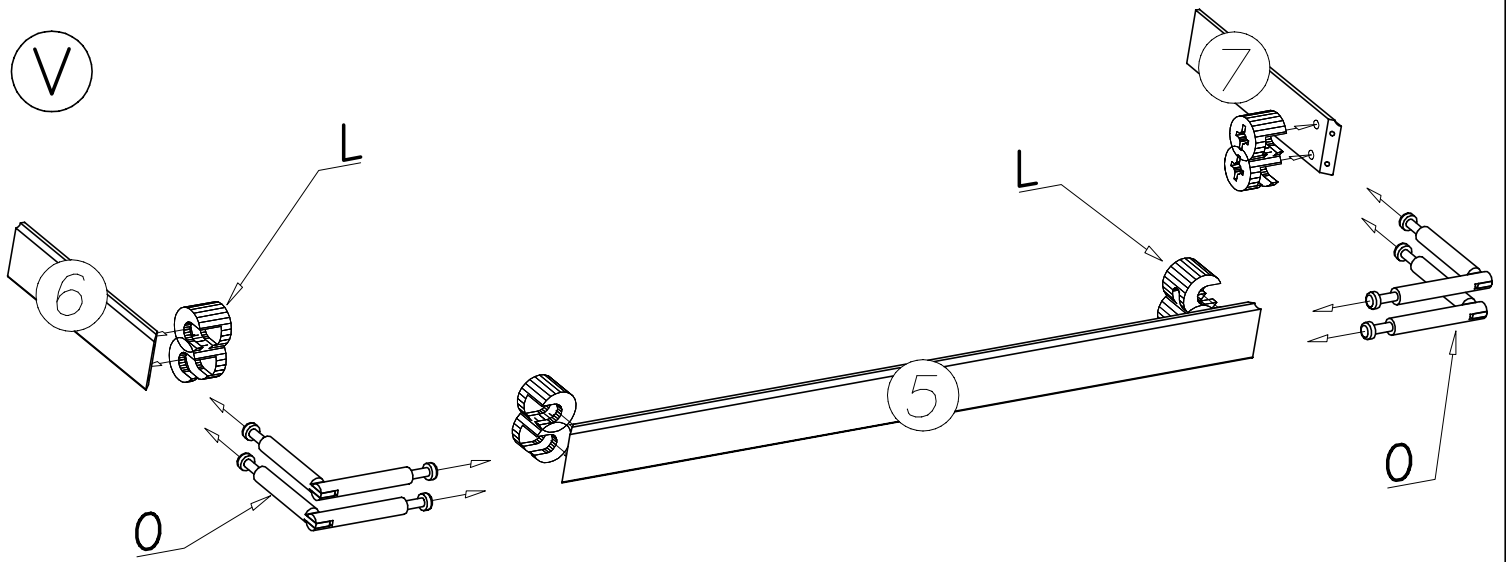

VI

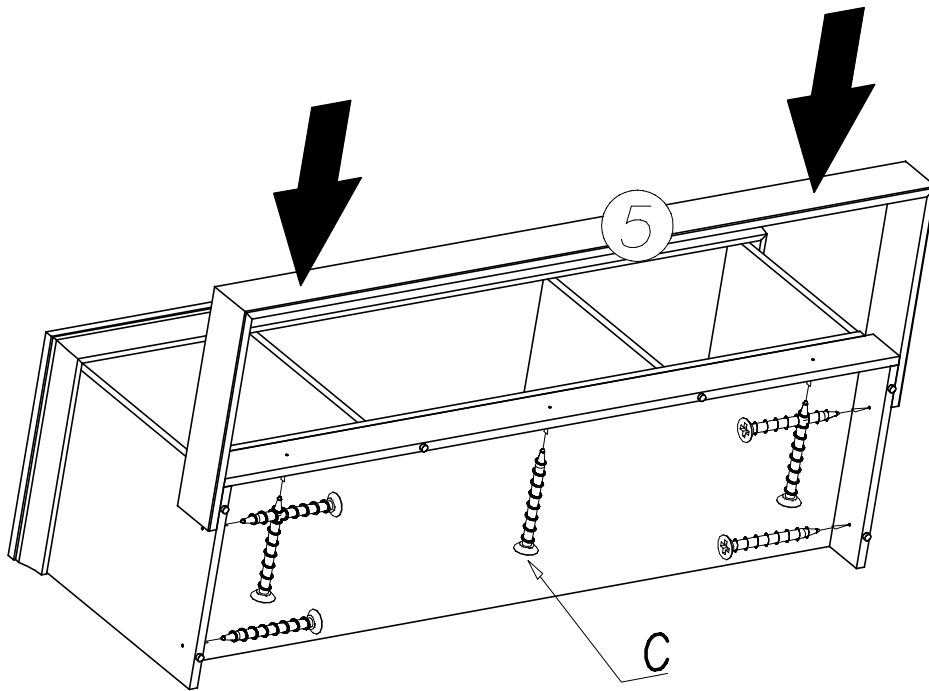

VII

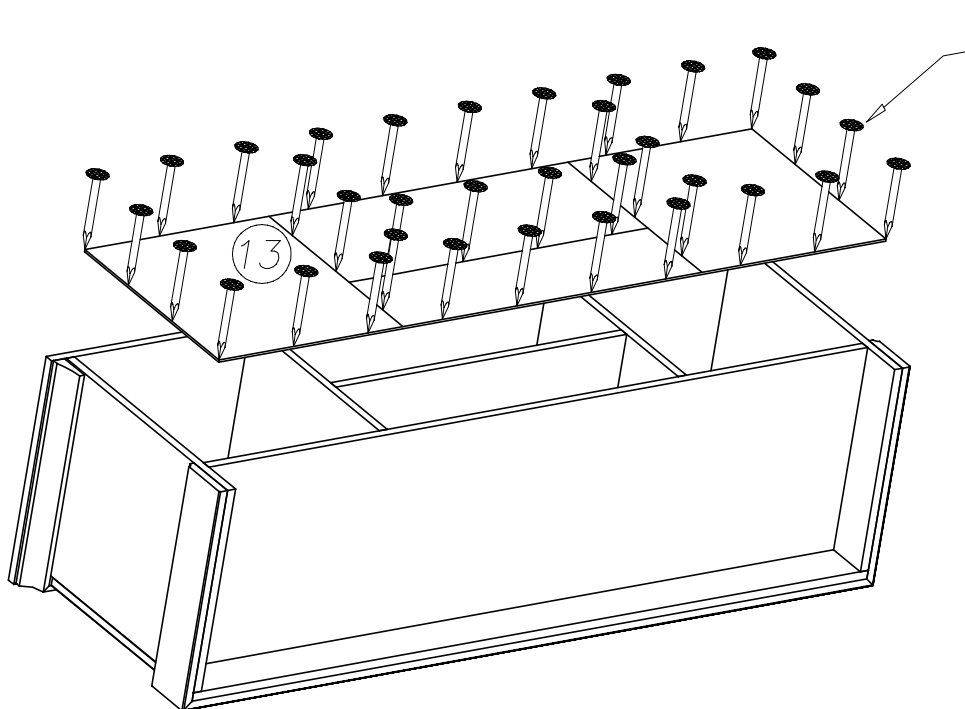

VIII

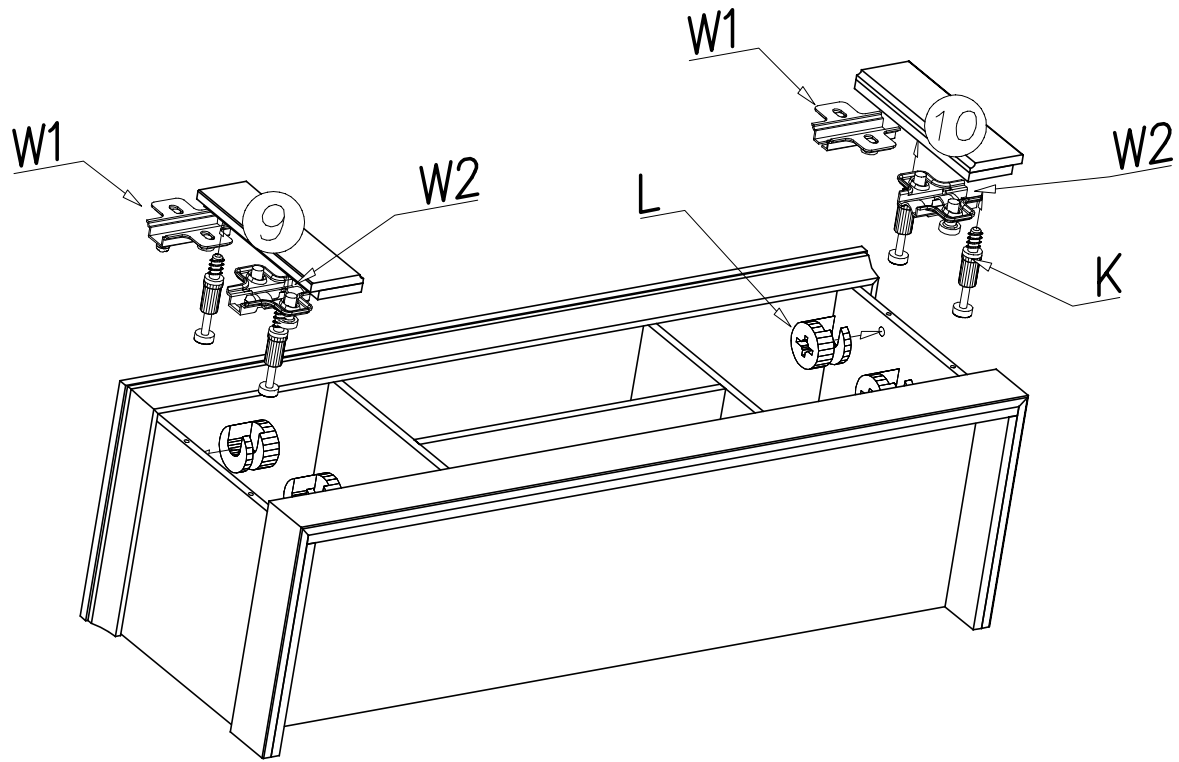

IX

