





F50		x3
E4		x6
	6x8	
K2		x6
	7x70	
L6		x2

Nr	Ausmaß			St
1	1540	240	16	1
2	1534	220	15	1



1

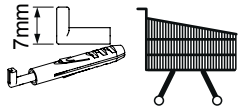
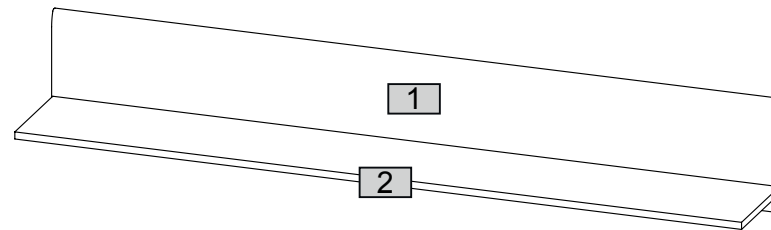
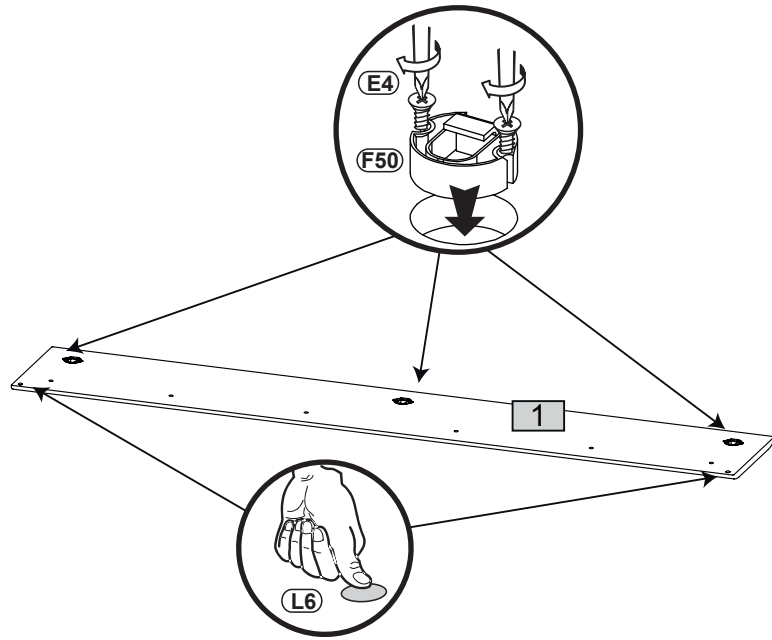
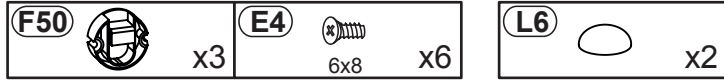

2

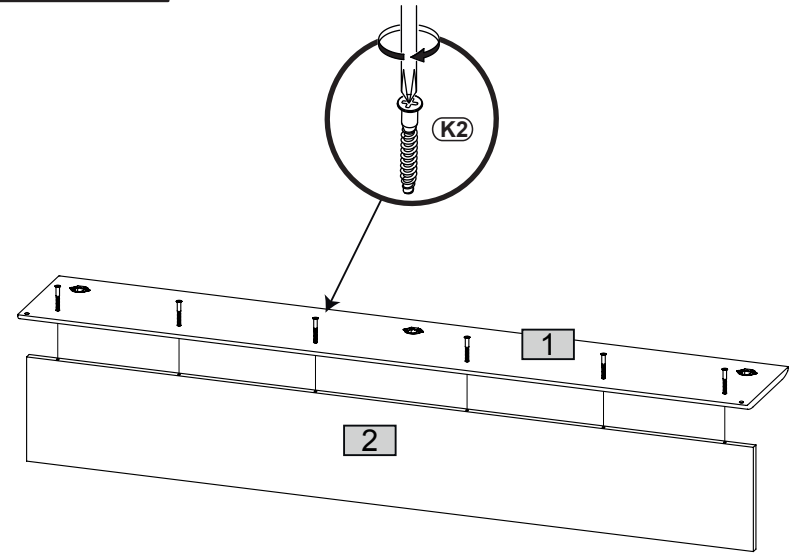
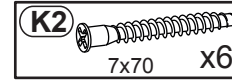

3

