

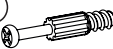





<b>B1</b>		$\phi$ 8x28	x8
<b>T1</b>			x11
<b>M1</b>			x11
<b>C2</b>		$\phi$ 20	x4
<b>C2</b>		$\phi$ 20	x3
<b>K2</b>		7x70	x3
<b>F15</b>			x8

Nr	Ausmaß			St
1	433	80	60	2
2	433	80	60	2
3	277	468	22	1
4	1080	470	15	1
5	1100	600	22	1



0 10 20 30 40 50 60 70 80 90 100 110 120 130 140 150 160 170 180 190 200

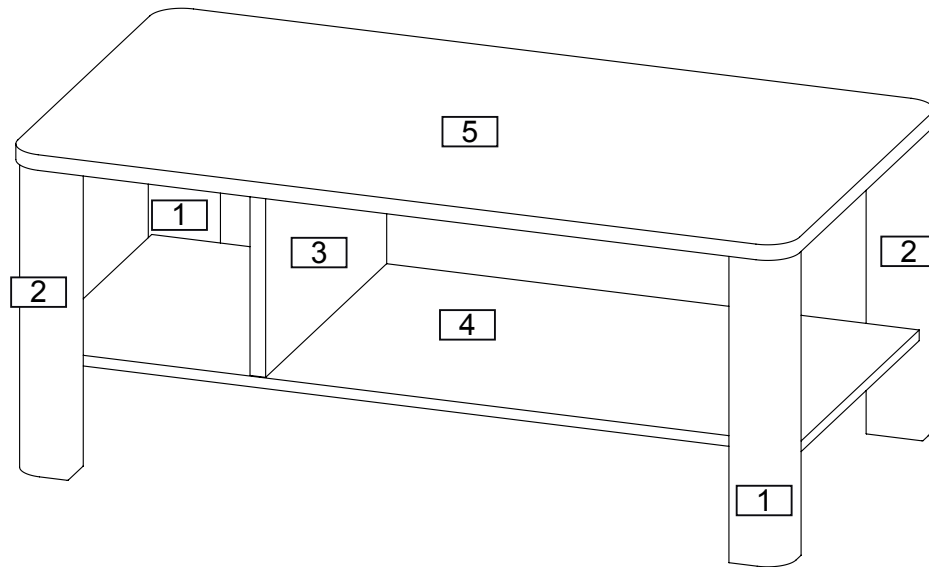

1

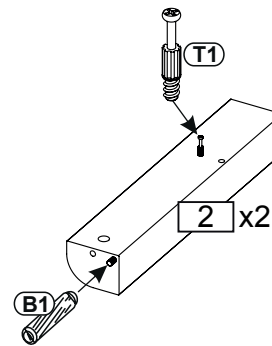
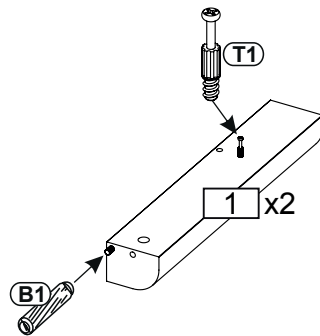
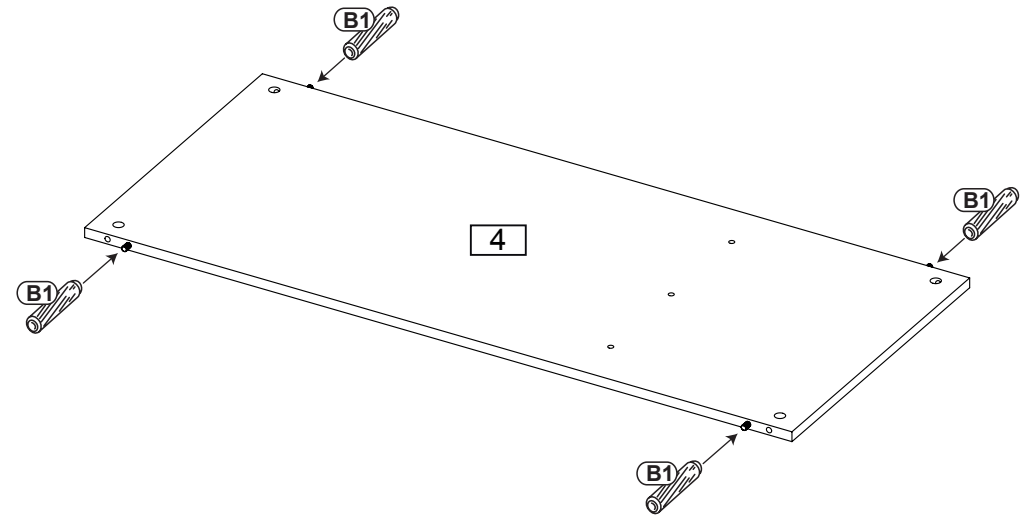
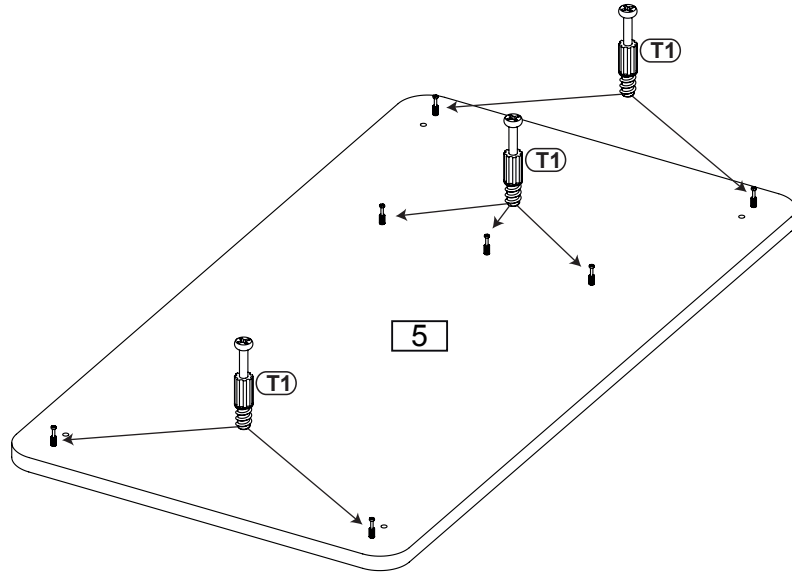
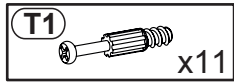
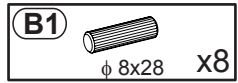

2

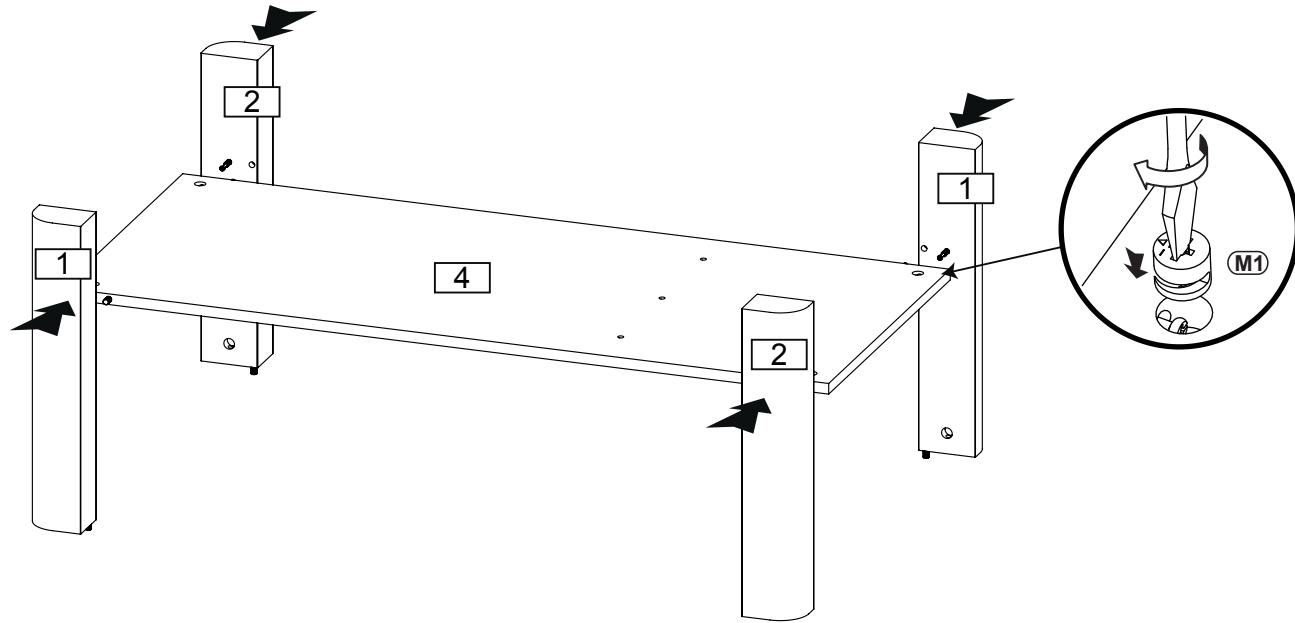

3

