

L

R

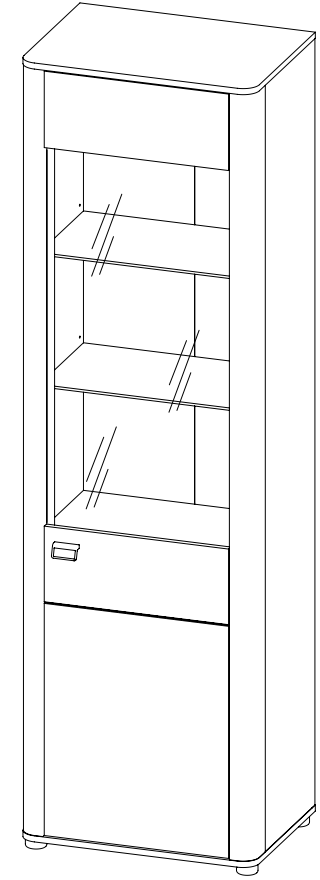

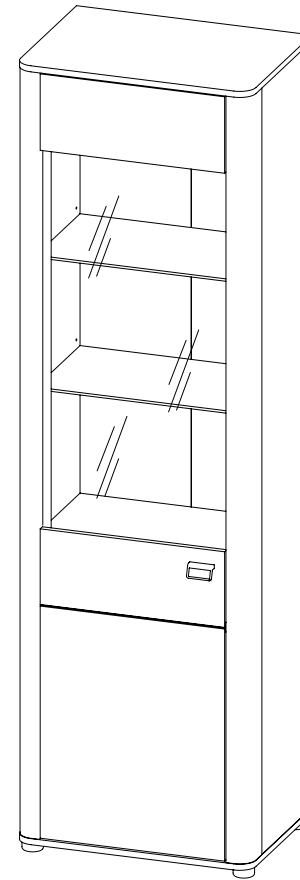
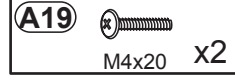
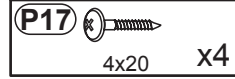
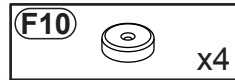
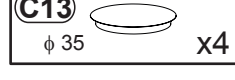
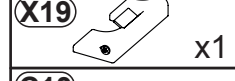
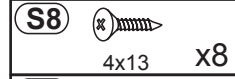
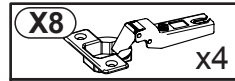
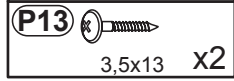
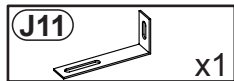
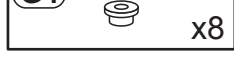
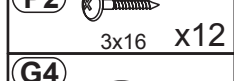
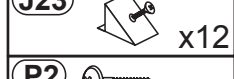
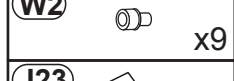
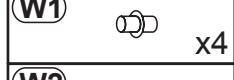
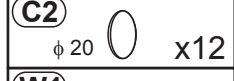
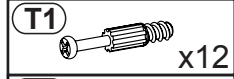
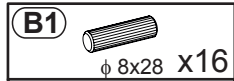

Nr	Ausmaß			St	Colli
1	549	300	6	2	2
2	996	454	4	1	1
3	1896	418	60	1	1
4	1896	418	60	1	1
7	765	456	15	1	2
8	456	189	15	1	2
10	550	382	15	1	2
11	550	310	15	1	2
12	582	420	15	1	2
13	582	420	15	1	2
14	1910	282	2	2	1

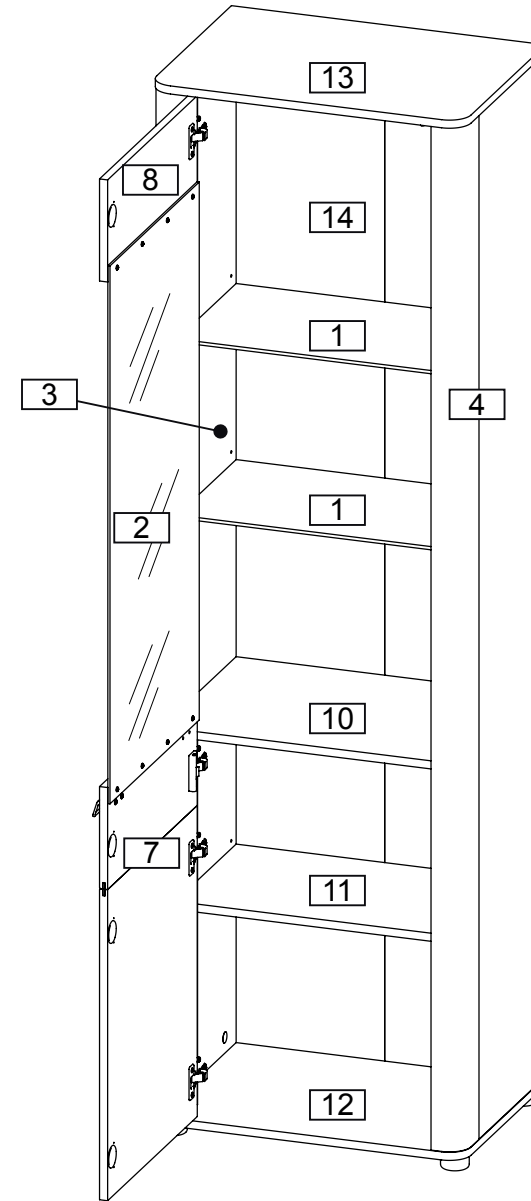



0 10 20 30 40 50 60 70 80 90 100 110 120 130 140 150 160 170 180 190 200



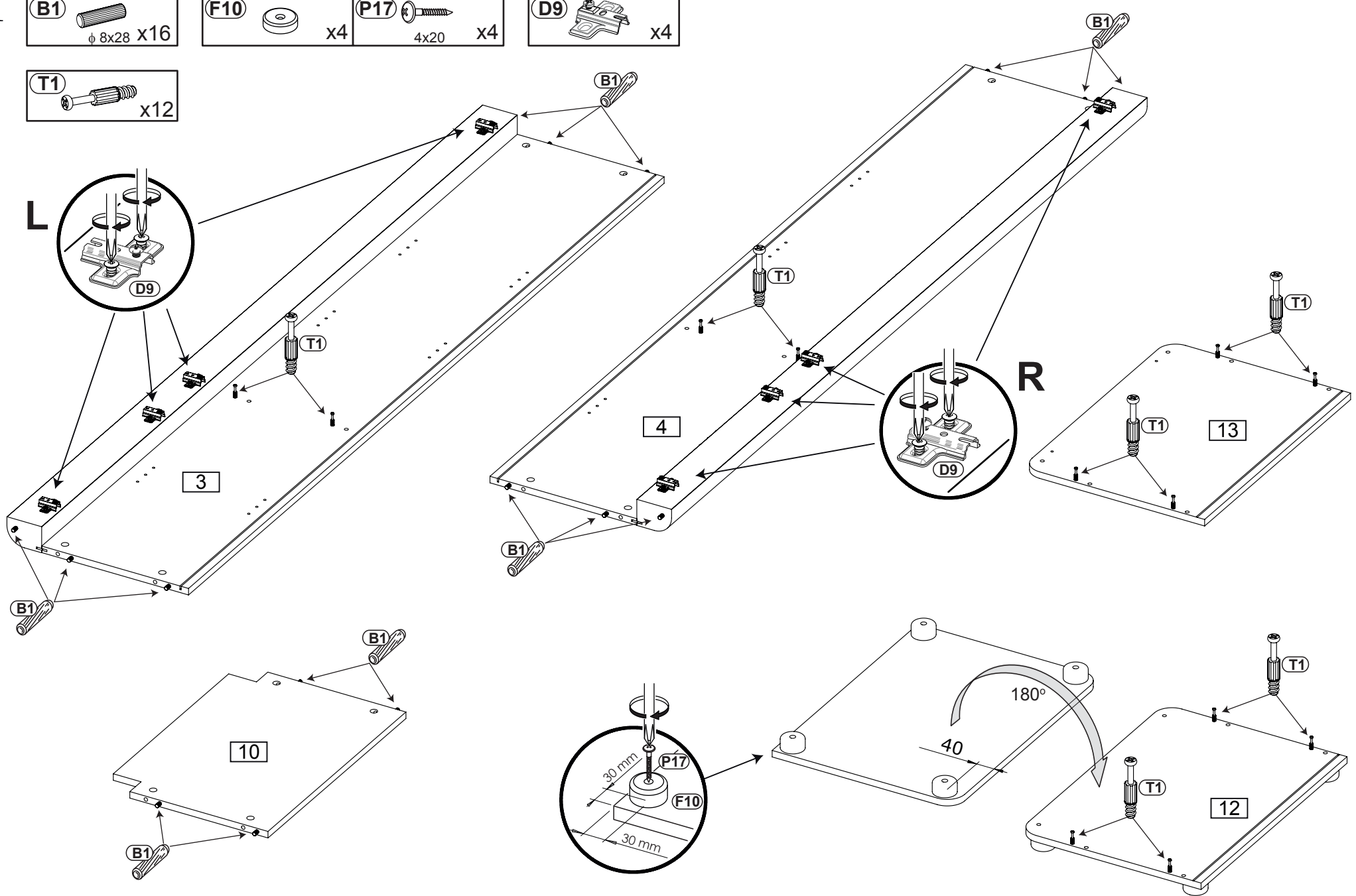

- 1**
- B1** ϕ 8x28 x16 x4
 - F10** x4
 - P17** 4x20 x4
 - D9** x4
 - T1** x12



2

G4  x8 **P2**  3x16 x8

X8  x4 **S8**  4x13 x8

C13  ϕ 35 x4

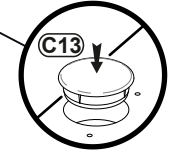
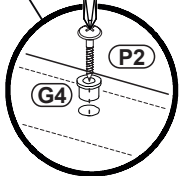
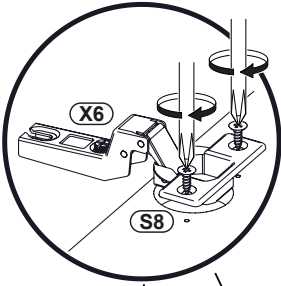
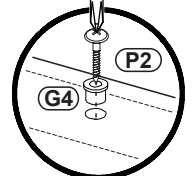
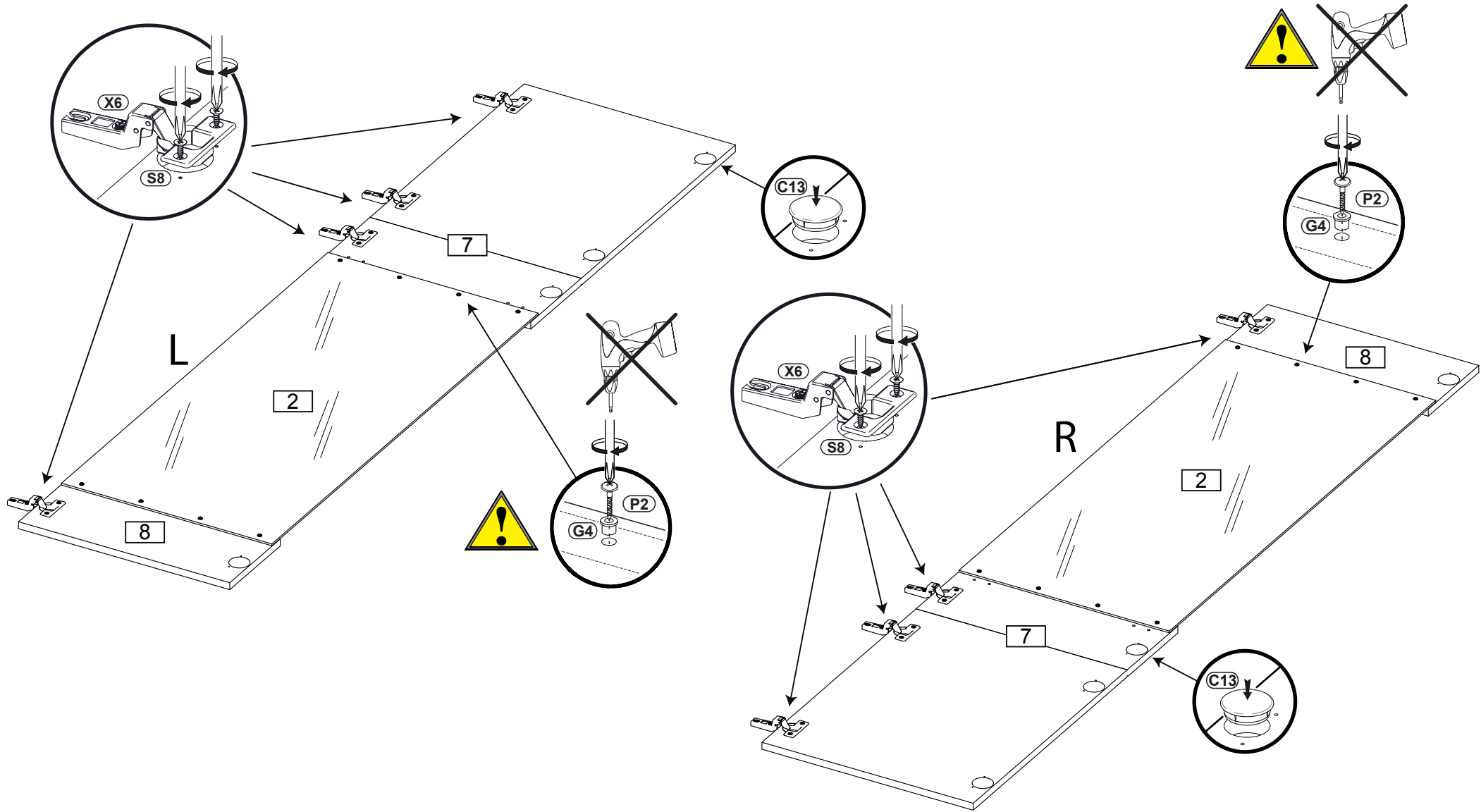

3

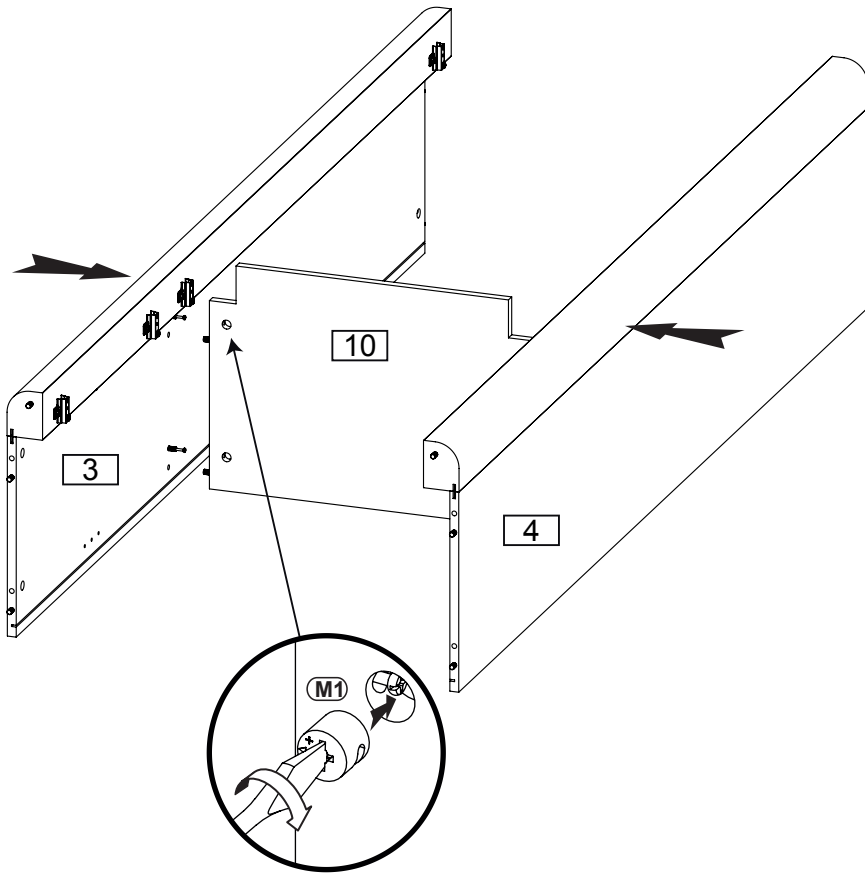

4

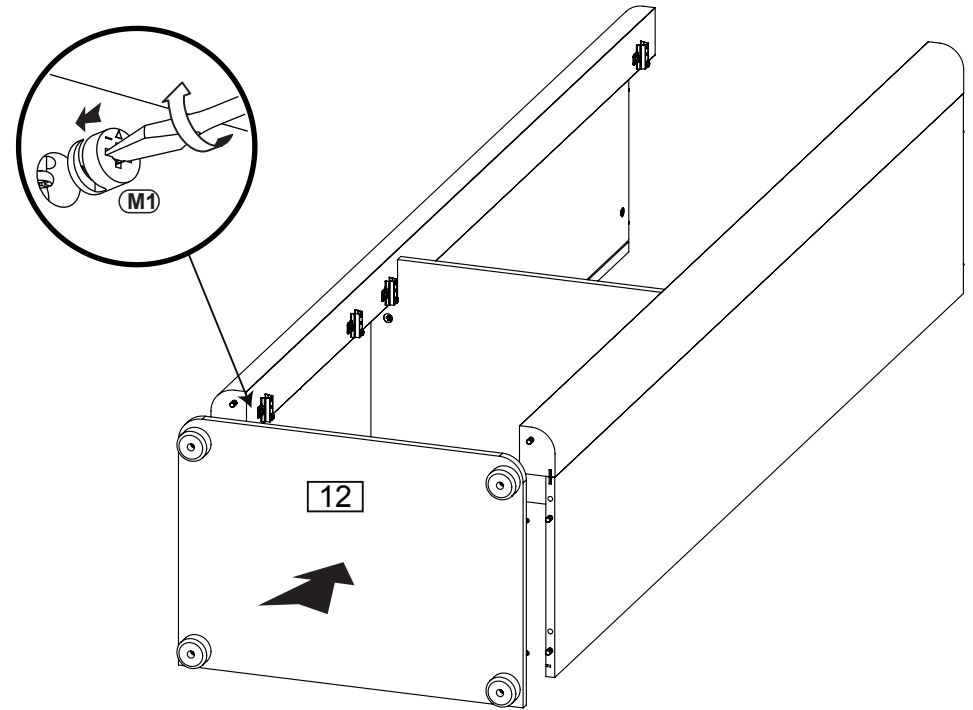

5

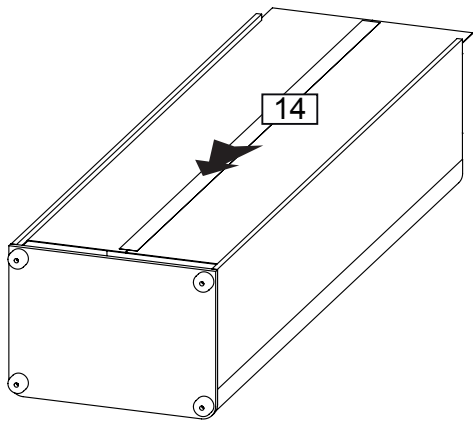
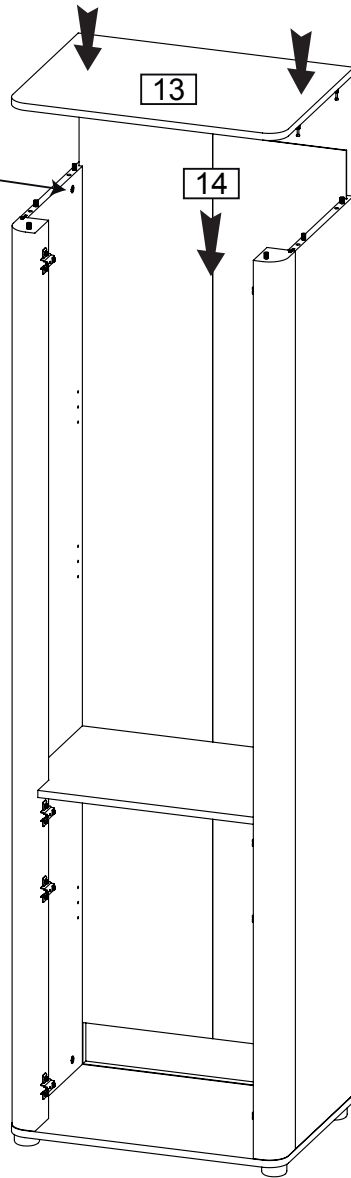
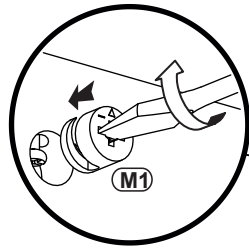

6

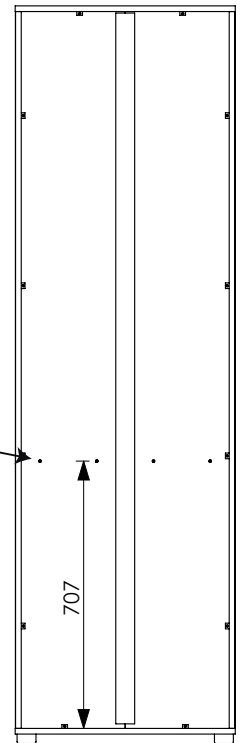
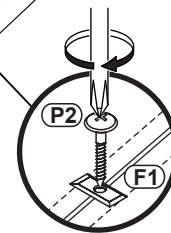
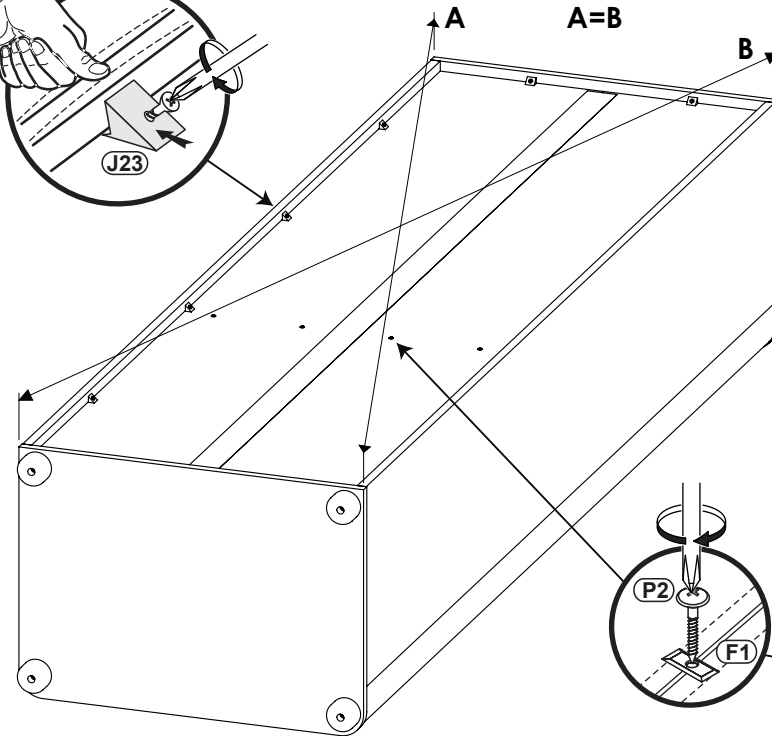
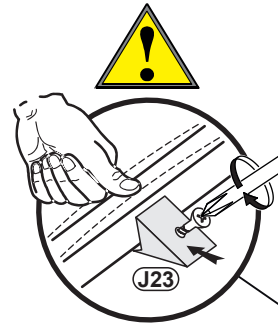
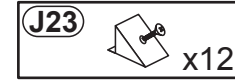
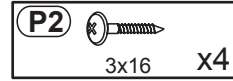

7

