

system VEGAS

V-5

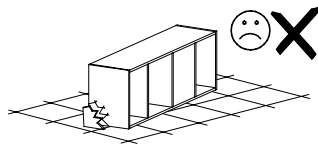

Narzędzia potrzebne do montażu

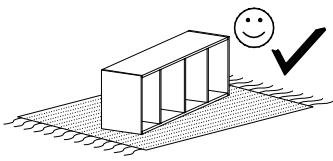
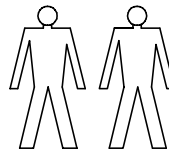
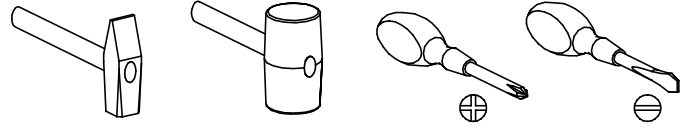

UWAGA !!

MONTOWANIE USZKODZONYCH
ELEMENTÓW POWODUJE UTRATĘ
GWARANCJI

nr	D[mm]	S[mm]	G[mm]	Ilość
1	1082	407	48	1
2	1082	407	48	1
3	780	405	48	1
4	1047	387	16	1
5	780	405	48	1
6	382	387	16	1
7	382	387	16	1
8	1070	417	2,5	2
9	487	385	16	2
10	487	385	16	2

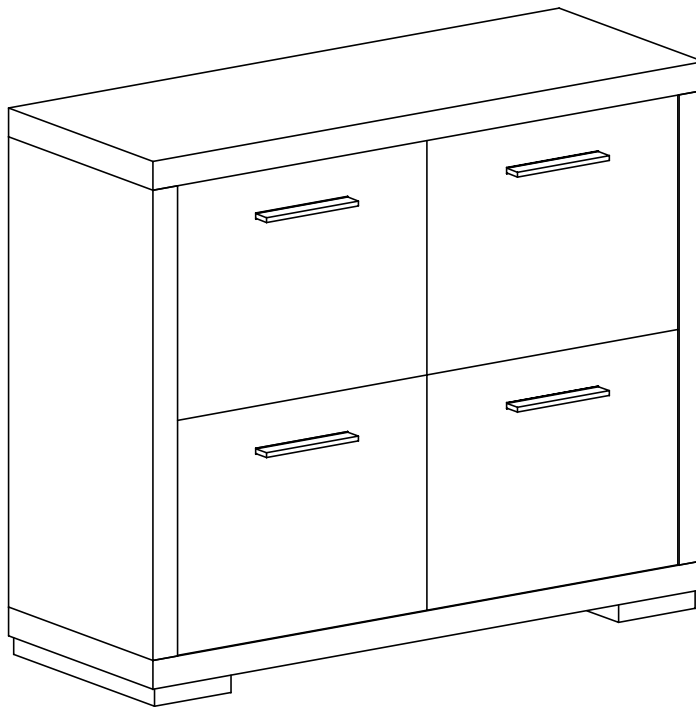

W przypadku reklamacji proszę o podanie numeru pakowacza znajdującego się na kartonie



A - 2 St.



L - 16 St.

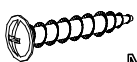

N - 8 St.
4 x 30 mm



U - 4 St.

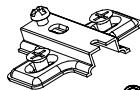

C - 8 St.

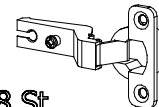

D - 8 St.



G - 16 St.
3,5 x 16 mm



E - 50 St.

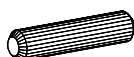

B - 16 St.

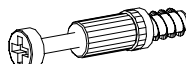

K - 16 St.

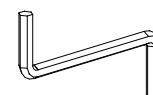

Z - 1 St.

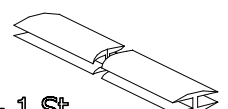

H - 1 St.

I

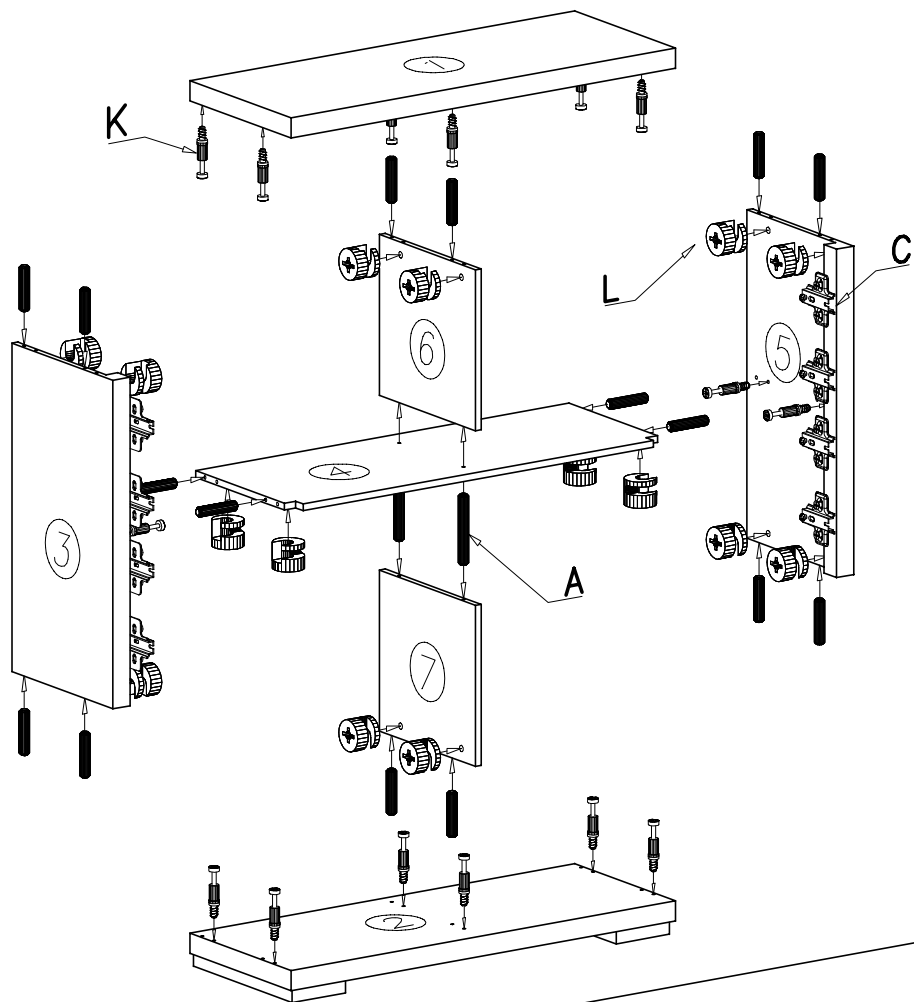

II

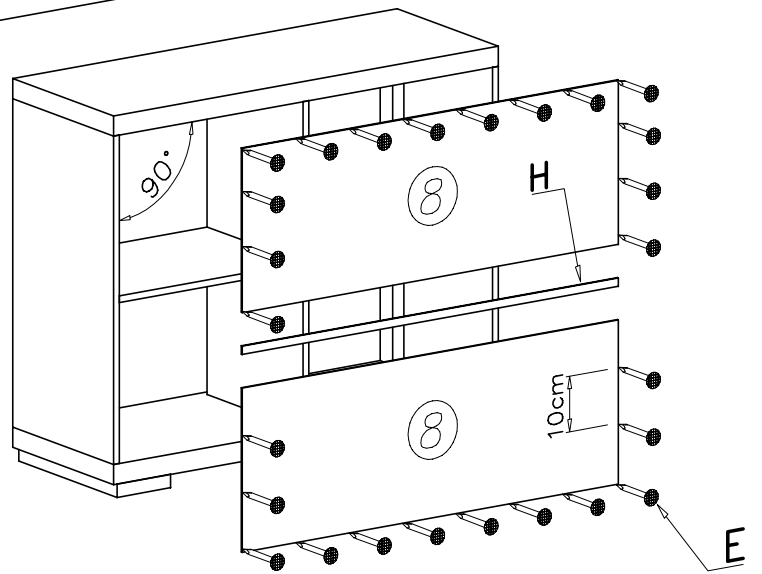

III

