

# system VEGAS

## V-38

# INSTRUKCJA MONTAŻU

Narzędzia potrzebne do montażu

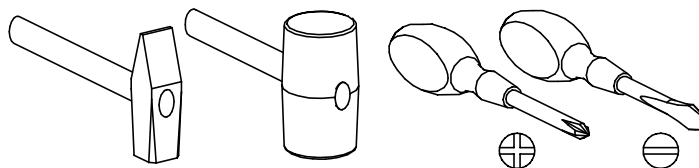
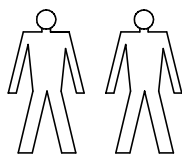

### UWAGA !!

MONTOWANIE USZKODZONYCH  
ELEMENTÓW POWODUJE UTRATĘ  
GWARANCJI

nr	D[mm]	S[mm]	G[mm]	Ilość
1	900	900	48	1
2	900	900	48	1
3	1790	460	48	1
4	1790	490	48	1
5	1790	350	16	1
6	1790	350	16	1
7	350	355	16	4
8	867	80	16	1
9	1780	557	16	1
10	1815	445	2,5	2
11	1815	282	2,5	2

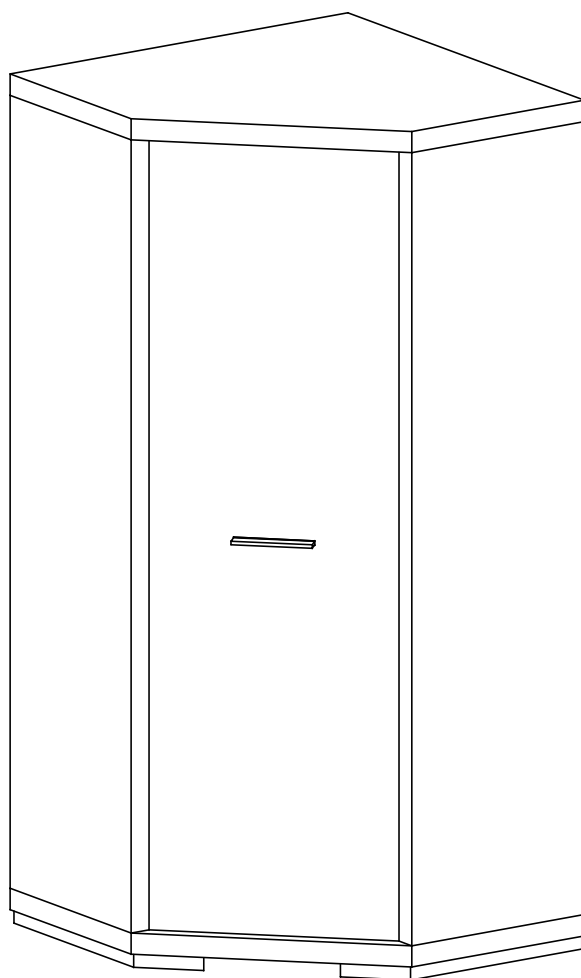

W przypadku reklamacji proszę o podanie numeru pakowacza znajdującego się na kartonie

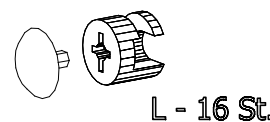
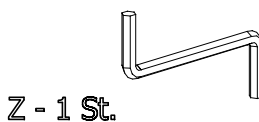
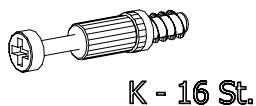
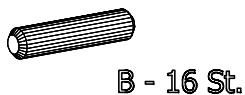
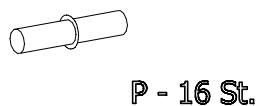
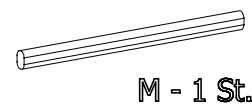
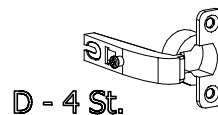
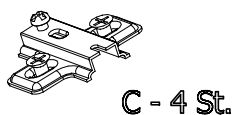
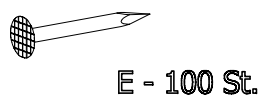
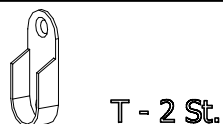
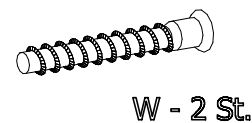
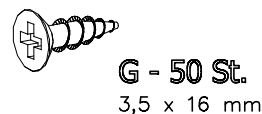
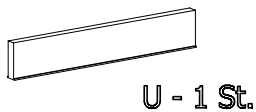
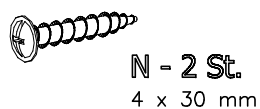
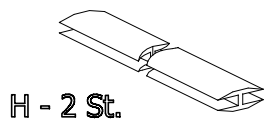

1

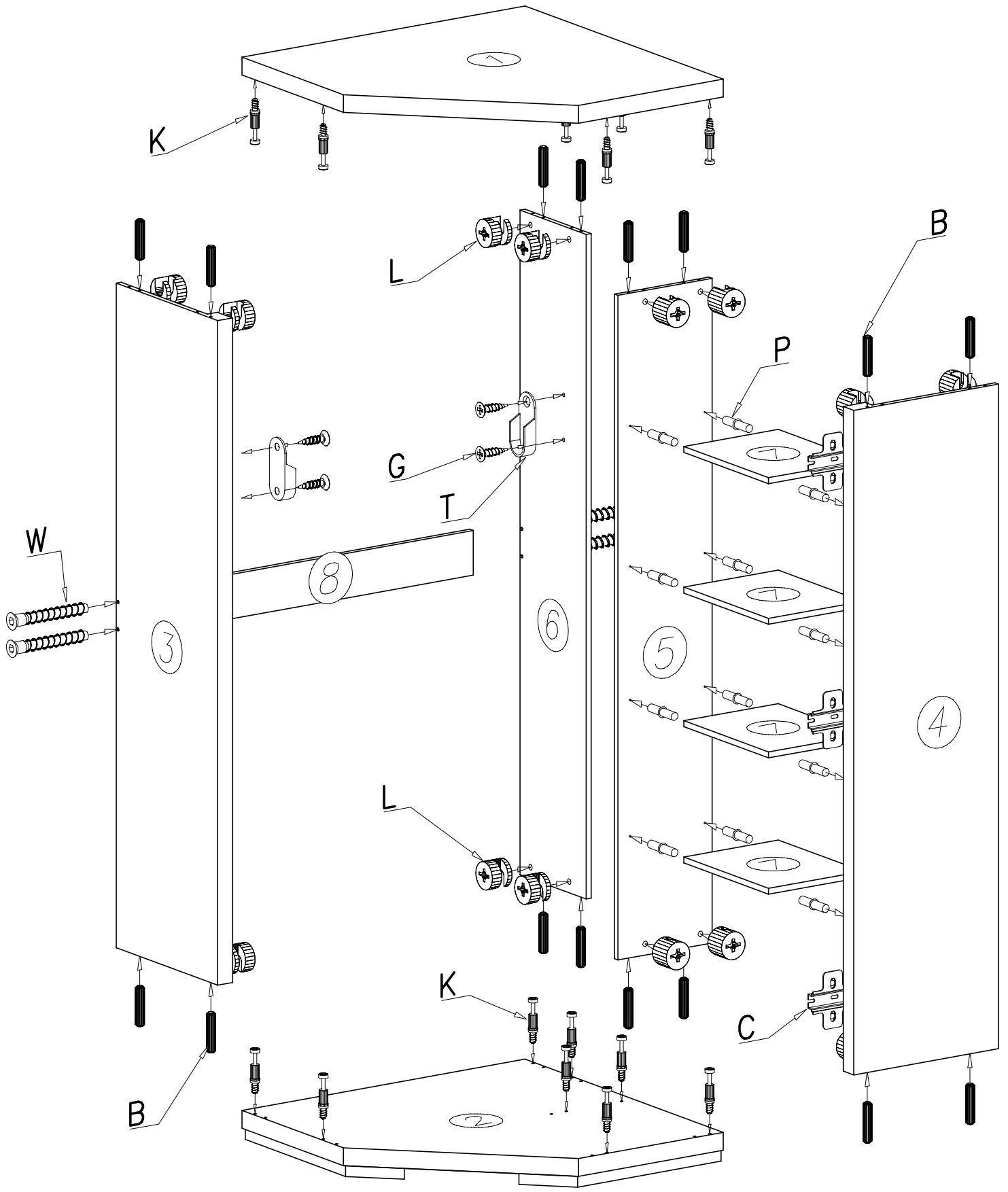

II

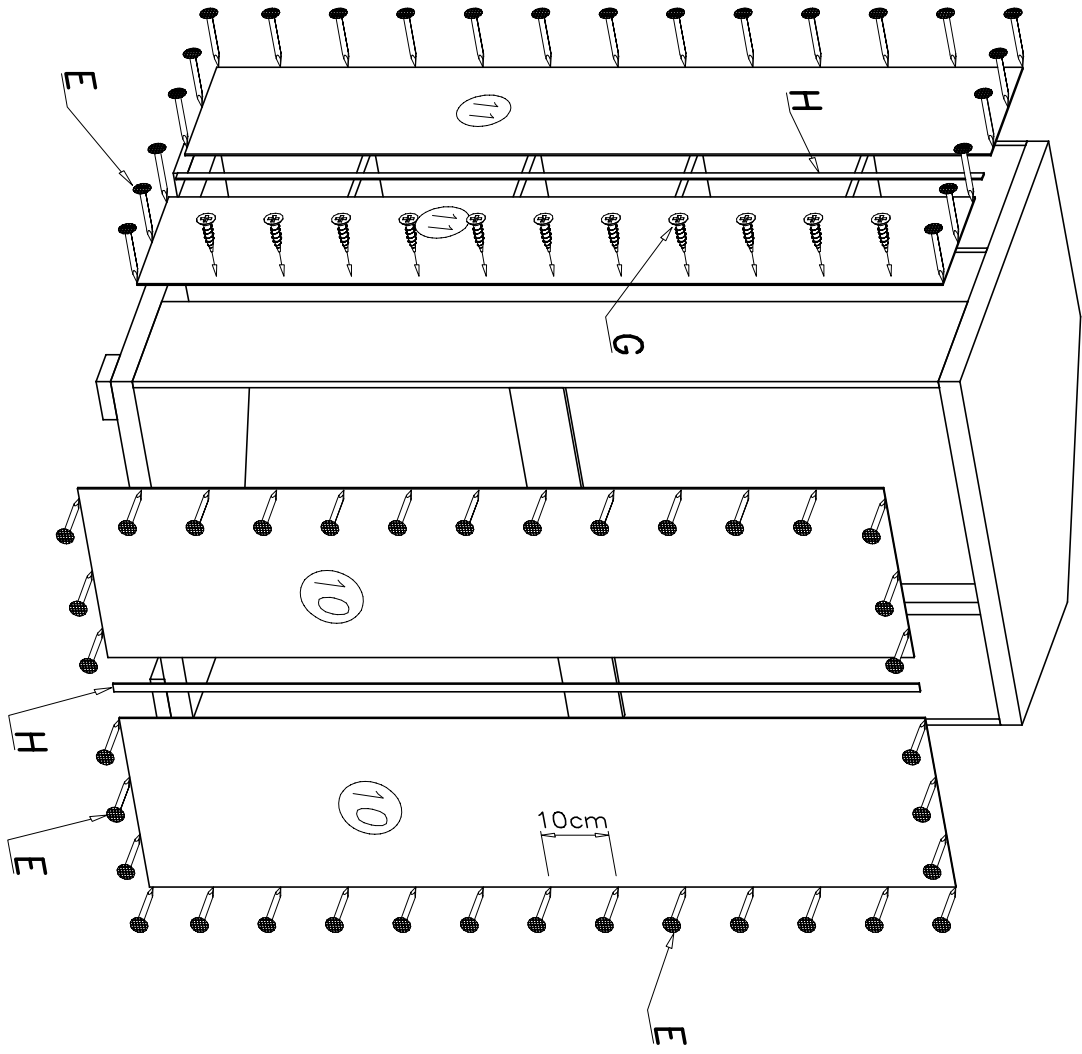

III

