

# system VEGAS

## V-32

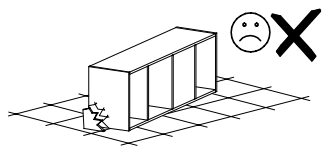

Narzędzia potrzebne do montażu

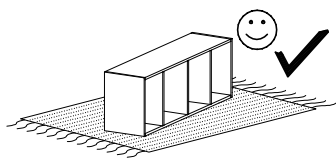
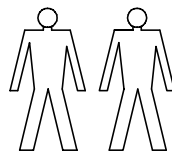
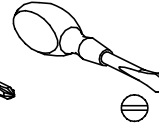
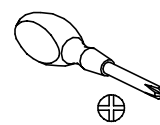
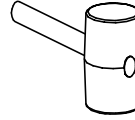
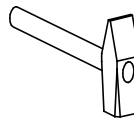

### UWAGA !!

MONTOWANIE USZKODZONYCH  
ELEMENTÓW POWODUJE UTRATĘ  
GWARANCJI

nr	D[mm]	S[mm]	G[mm]	Ilość
1	671	671	48	1
2	724	620	48	1
3	724	667	48	1

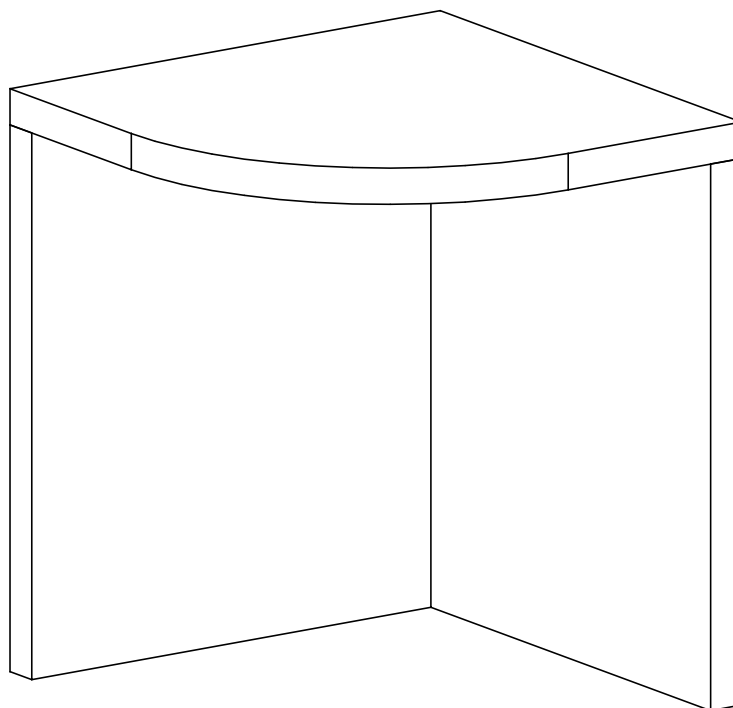

W przypadku reklamacji proszę o podanie numeru pakowacza znajdującego się na kartonie



Q - 4 St.

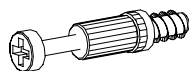

K - 9 St.

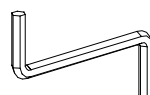

Z - 1 St.



B - 9 St.



L - 9 St.

