

BELLO 3

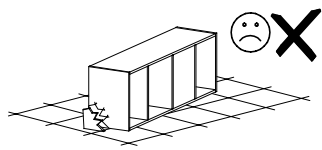

Narzędzia potrzebne do montażu

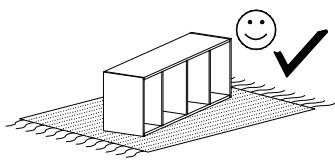
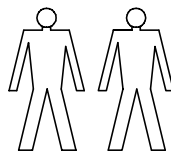
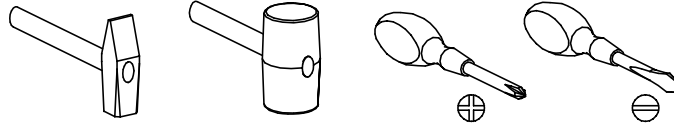

UWAGA !!

MONTOWANIE USZKODZONYCH
ELEMENTÓW POWODUJE UTRATĘ
GWARANCJI

nr	D[mm]	S[mm]	G[mm]	Ilość
1	811	405	16	1
2	811	405	16	1
3	1790	405	16	1
4	1790	405	16	1
5	776	405	16	1
6			2,5	2
7	776	380	16	3
8	665	402	16	1
9	665	402	16	1
10			4	1
11			4	1
12	1152	152	16	2

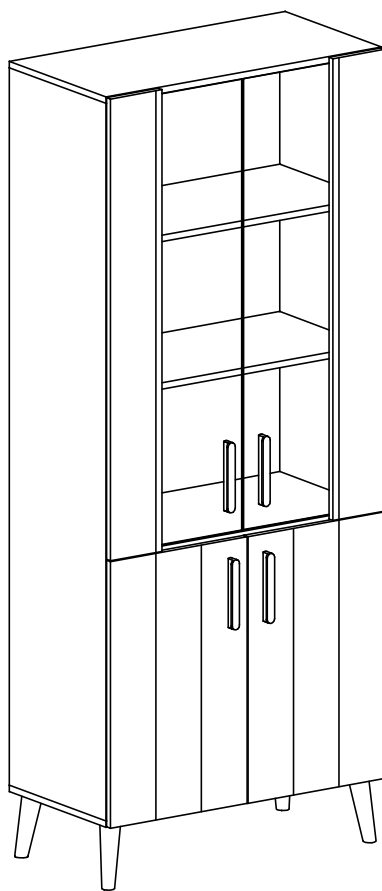

W przypadku reklamacji proszę o podanie numeru pakowacza znajdującego się na kartonie

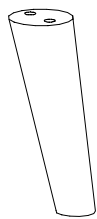

P - 4 St.

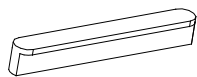

U - 4 St.

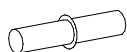

F - 12 St.



X - 4 St.
3,5 x 20 mm

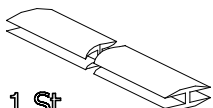

H - 1 St.



R - 10 St.

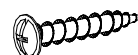

N - 4 St.
3 x 25 mm



Z - 1 St.

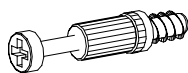

K - 8 St.



L - 8 St.

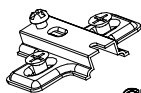

C2 - 6 St.

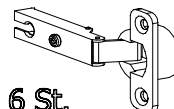

D2 - 6 St.



B - 12 St.



E - 90 St.

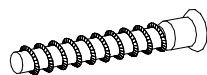

W - 12 St.



C1 - 4 St.

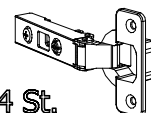

D1 - 4 St.



G - 26 St.
3,5 x 16 mm

I

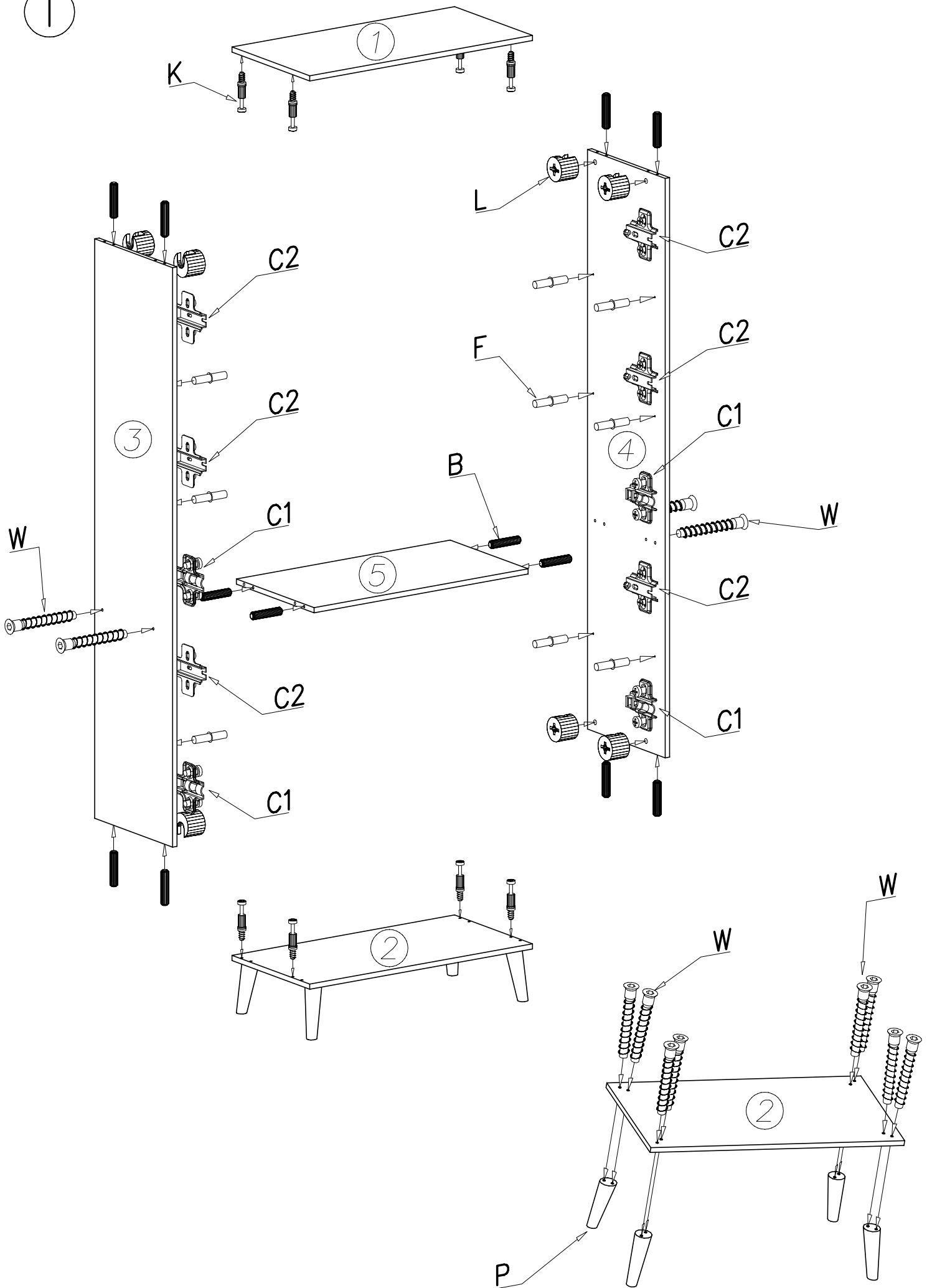

II

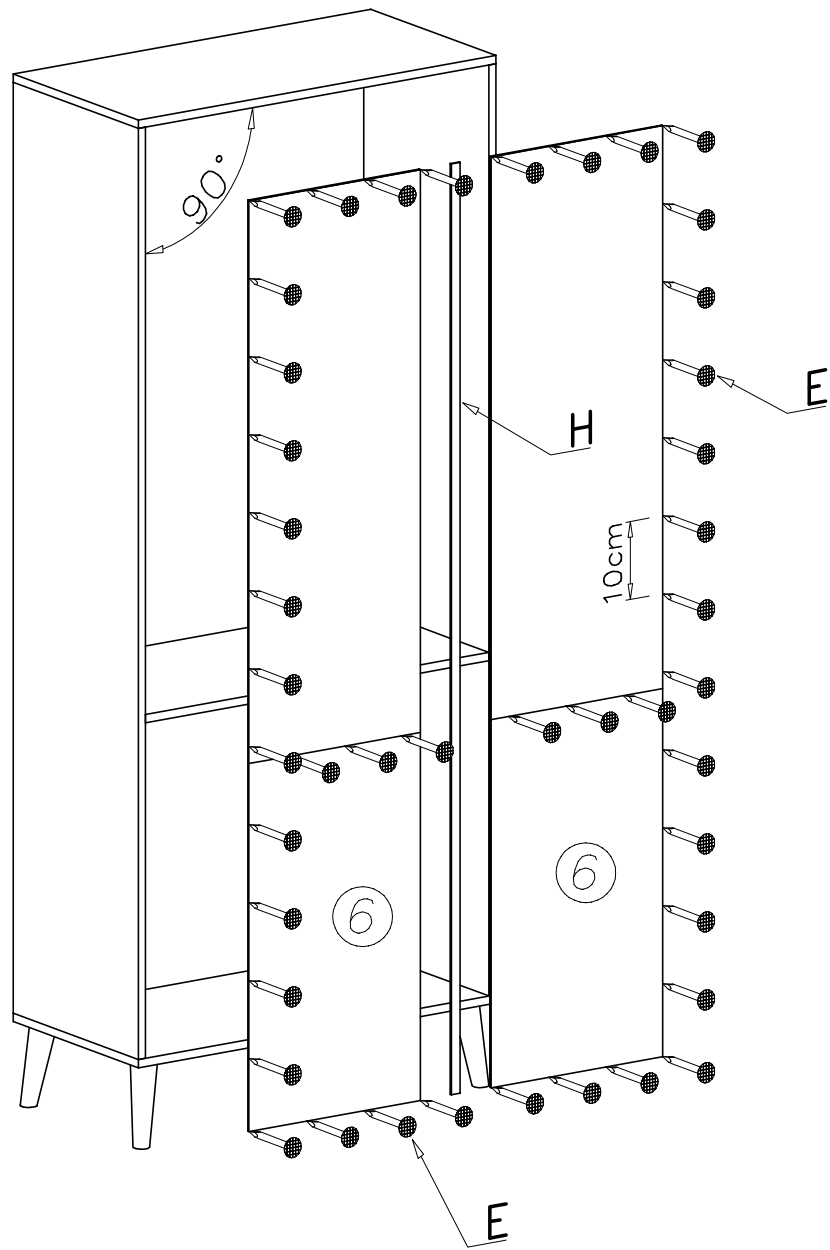

III

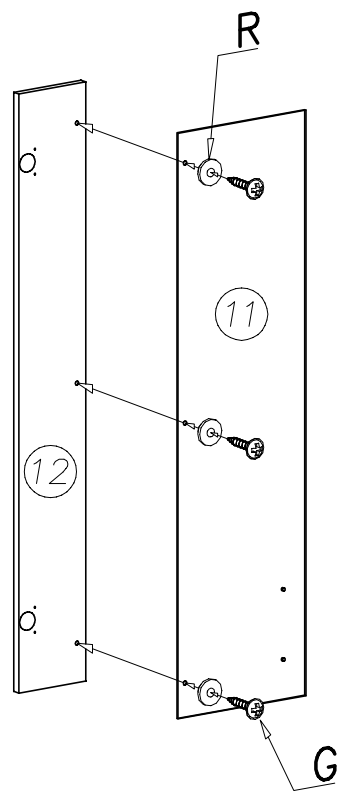
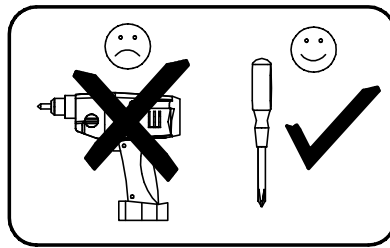
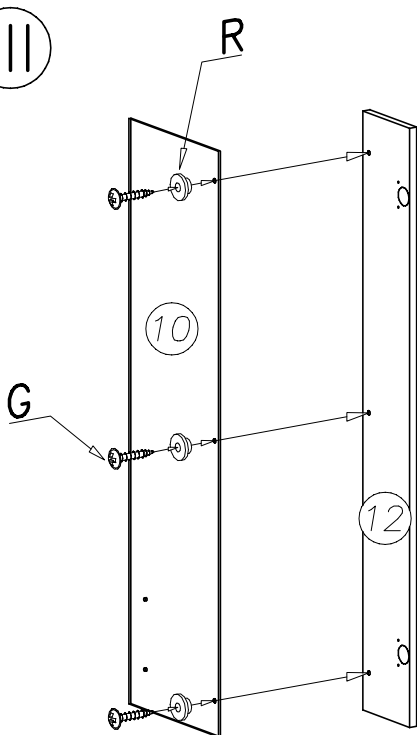

IV

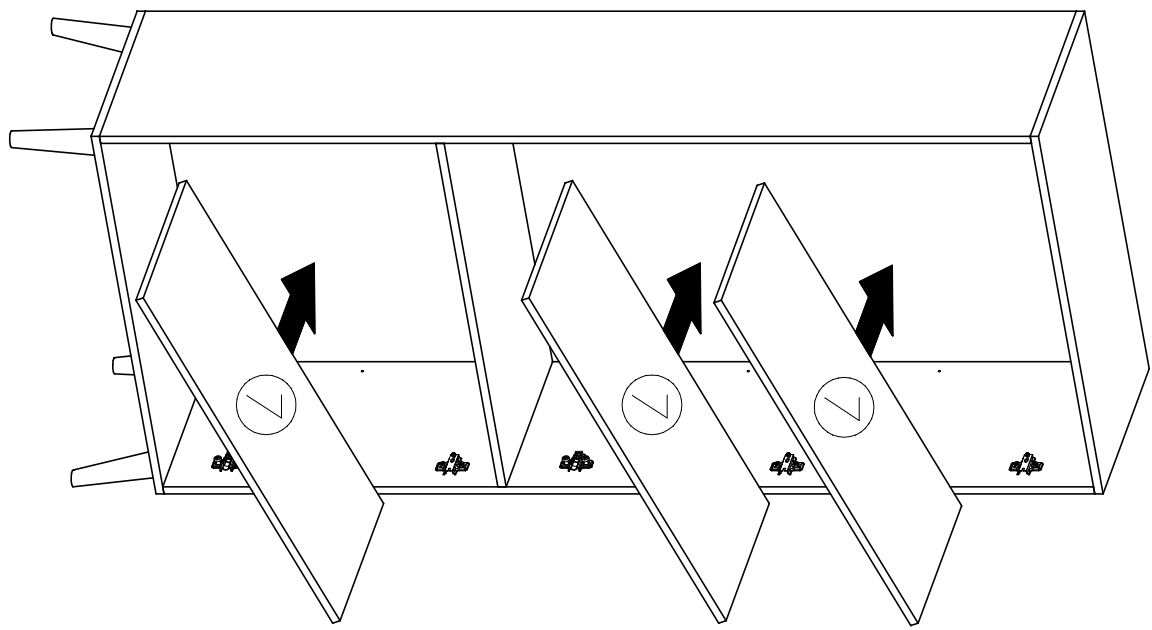

VIII

