

system VEGAS

V-10

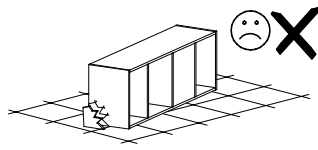

Narzędzia potrzebne do montażu

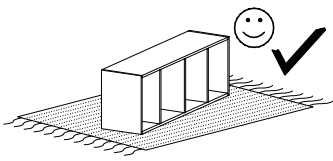
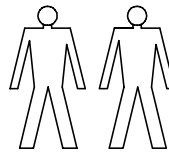
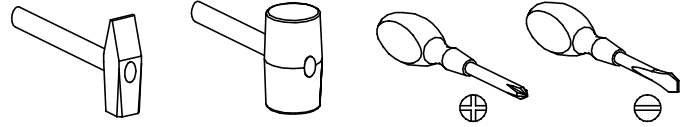

UWAGA !!

MONTOWANIE USZKODZONYCH
ELEMENTÓW POWODUJE UTRATĘ
GWARANCJI

nr	D[mm]	S[mm]	G[mm]	Ilość
1	451	407	48	1
2	451	407	48	1
3	427	405	48	1
4	427	405	48	1
5	480	440	2,5	1
6	345	137	16	3
7	293	107	16	3
8	107	350	16	3
9	107	350	16	3
10	322	355	2,5	3

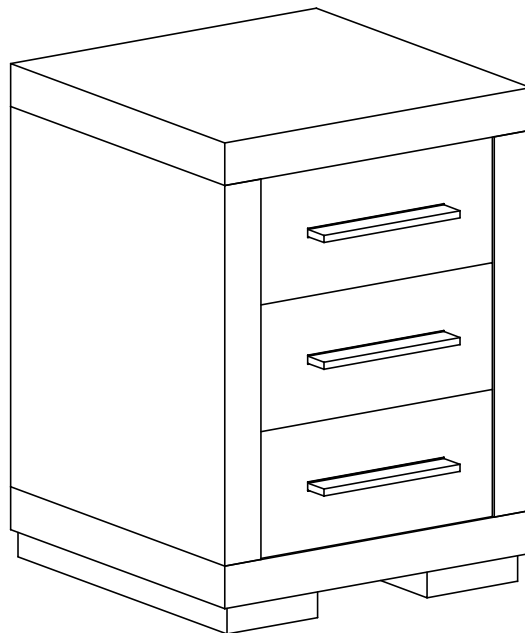

W przypadku reklamacji proszę o podanie numeru pakowacza znajdującego się na kartonie

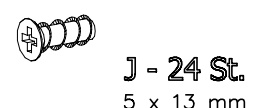
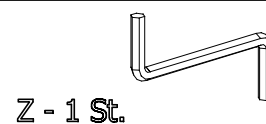
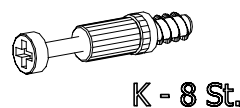
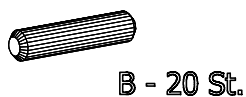
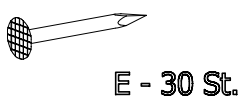
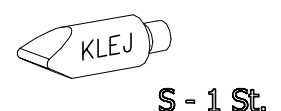
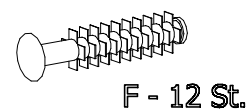
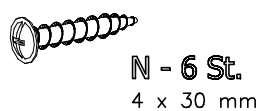
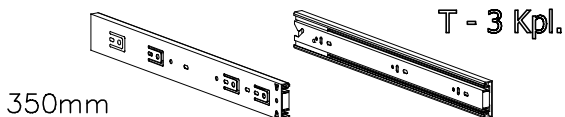
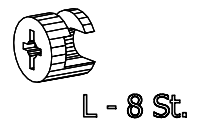
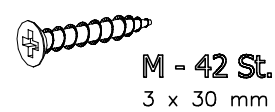
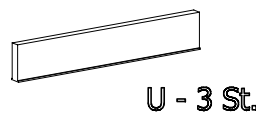

I

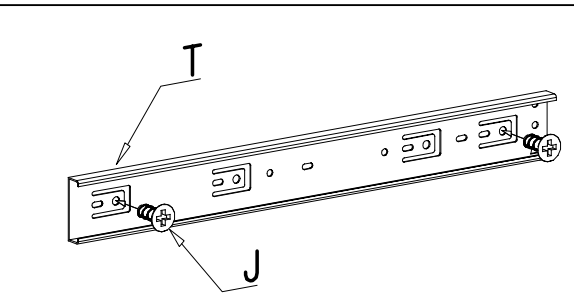
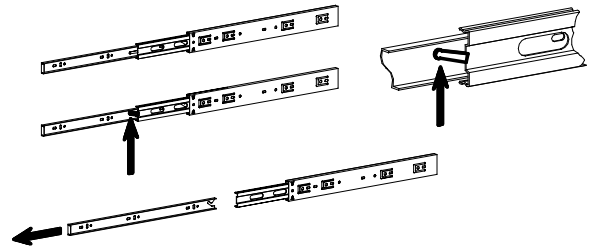
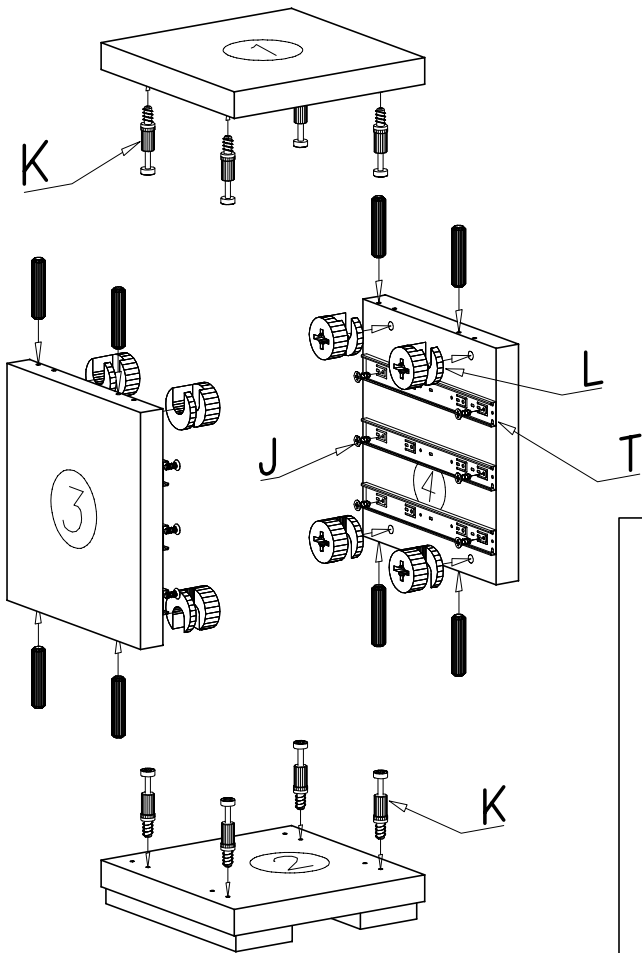

III

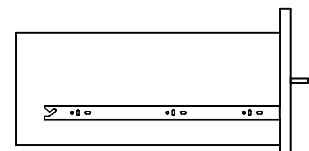
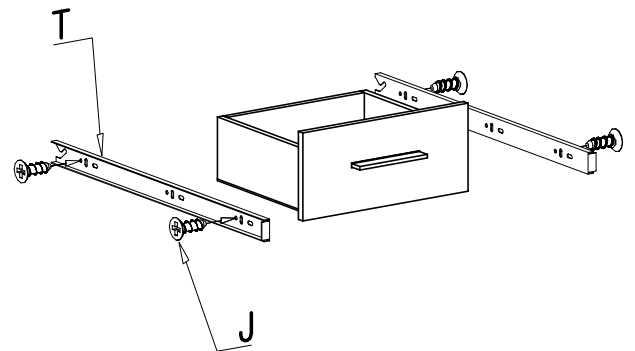
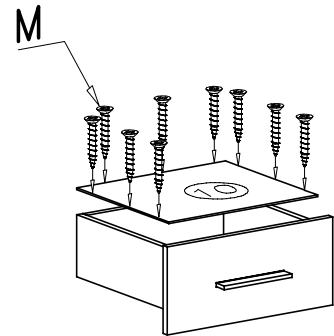
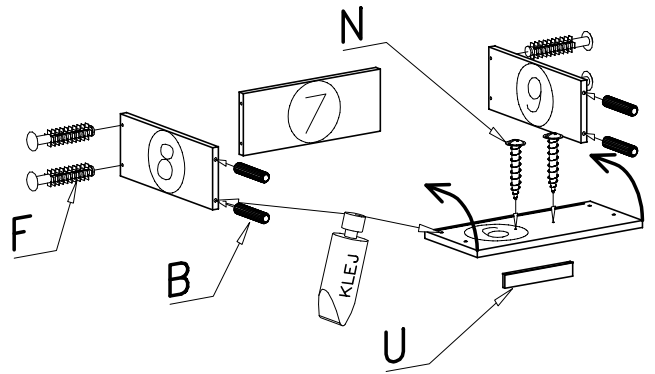

II

